



PROGRAMMABLE CONTROLLERS
MELSEC-Q-F

FX3U-CAN

INSTALLATION MANUAL



Manual Number	JY997D43201
Revision	D
Date	August 2016



This manual describes the part names, dimensions, mounting, and specifications of the product. Before use, read this manual and the manuals of all relevant products fully to acquire proficiency in handling and operating the product. Make sure to learn all the product information, safety information, and precautions. Store this manual in a safe place so that it can be taken out and read whenever necessary. Always forward it to the end user.

Registration:
 • CIA® and CANopen® are registered Community Trademarks of CAN in Automation e.V.
 • The company and product names described in this manual are registered trademarks or the trademarks of their respective companies.

Effective August 2016
 Specifications are subject to change without notice.
 © 2012 Mitsubishi Electric Corporation

Safety Precautions (Read these precautions before use.)

This manual classifies the safety precautions into two categories:

 **WARNING** and  **CAUTION**.

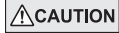
 WARNING	Indicates that incorrect handling may cause hazardous conditions, resulting in death or severe injury.
 CAUTION	Indicates that incorrect handling may cause hazardous conditions, resulting in medium or slight personal injury or physical damage.

Depending on the circumstances, procedures indicated by  **CAUTION** may also cause severe injury. It is important to follow all precautions for personal safety.

Associated Manuals

Manual name	Manual No.	Description
FX3U-CAN User's Manual	JY997D43301	Describes details of the FX3U-CAN Communication Special Function Block.
FX3G Series User's Manual - Hardware Edition	JY997D31301 MODEL CODE: 09R521	Explains the FX3G Series PLC specifications for I/O, wiring, installation, and maintenance.
FX3GC Series User's Manual - Hardware Edition	JY997D45401 MODEL CODE: 09R533	Explains the FX3GC Series PLC specifications for I/O, wiring, installation, and maintenance.
FX3U Series User's Manual - Hardware Edition	JY997D16501 MODEL CODE: 09R516	Explains the FX3U Series PLC specifications for I/O, wiring, installation, and maintenance.
FX3UC Series User's Manual - Hardware Edition	JY997D28701 MODEL CODE: 09R519	Explains the FX3UC Series PLC specifications for I/O, wiring, installation, and maintenance.
MELSEC IQ-F FX5U User's Manual (Hardware)	JY997D55301 MODEL CODE: 09R536	Explains the FX5U CPU module specification details for I/O, wiring, installation, and maintenance.
MELSEC IQ-F FX5UC User's Manual (Hardware)	JY997D61401 MODEL CODE: 09R558	Explains the FX5UC CPU module specification details for I/O, wiring, installation, and maintenance.

How to obtain manuals
 For product manuals or documents, consult with your local Mitsubishi Electric representative.

Certification of UL, cUL standards

FX3U-CAN units comply with the UL standards (UL, cUL).
 UL, cUL File Number: E95239
 Regarding the standards that comply with the main unit, please refer to either the FX series product catalog or consult with your nearest Mitsubishi product provider.

Compliance with EC directive (CE Marking)

This note does not guarantee that an entire mechanical module produced in accordance with the contents of this note will comply with the following standards. Compliance to EMC directive and LVD directive for the entire mechanical module should be checked by the user / manufacturer. For more information please consult with your nearest Mitsubishi product provider.
 Regarding the standards that comply with the main unit, please refer to either the FX series product catalog or consult with your nearest Mitsubishi product provider.

Requirement for Compliance with EMC directive

The following products have shown compliance through direct testing (of the identified standards below) and design analysis (through the creation of a technical construction file) to the European Directive for Electromagnetic Compatibility (2014/30/EU) when used as directed by the appropriate documentation.

Attention

This product is designed for use in industrial applications.
 Type: Programmable Controller (Open Type Equipment)
 Models: MELSEC FX3U series manufactured from April 1st, 2012 FX3U-CAN

Standard	Remark
EN61131-2:2007 Programmable controllers - Equipment requirements and tests	Compliance with all relevant aspects of the standard. EMI • Radiated Emission • Conducted Emission EMS • Radiated electromagnetic field • Fast transient burst • Electrostatic discharge • High-energy surge • Voltage drops and interruptions • Conducted RF • Power frequency magnetic field

Caution for Compliance with EC Directive

- Caution for wiring
 For noise prevention, please ground at least 35 mm (1.38") of the twisted-pair cable along the grounding plate to which the ground terminal is connected. → Refer to subsection 3.2.3
- Installation in Enclosure → For details regarding installation in an enclosure, refer to User's Manual - Hardware Edition of the respective PLC main unit

1. Introduction

The FX3U-CAN communication block is an interface block that allows FX3G/FX3GC/FX3U/FX3UC/FX5U/FX5UC PLCs to connect to a CANopen® system. FX3U-CAN can be connected directly to the FX3G/FX3GC¹/FX3U/FX3UC¹/FX5U²/FX5UC² PLC's extension port, or to any other extension unit / block's right side extension port.

- 80 TPDO /80 RPDO (8 bytes / PDO) can be sent and received to/from a CANopen® network. However, in the MPDO protocol for Lift Application Profile, the size of the data of these objects is limited to a maximum of 4 bytes.
- CANopen® device/application Profiles according to CIA® Standards
 - Interface and Device Profile CIA® 405 V2.0 for IEC 61131-3 Programmable Devices
 - Application Profile CIA® 417 V2.1 for lift control systems
 - CAN Layer 2 communication

¹ An FX2NC-CNV-IF or FX3UC-1PS-5V is necessary to connect the FX3U-CAN to an FX3GC/FX3UC Series PLC.
² An FX5-CNV-BUS or FX5-CNV-BUSC is necessary to connect the FX3U-CAN to an FX5U/FX5UC PLC.

For safe use	 CAUTION
<ul style="list-style-type: none"> This product has been manufactured as a general-purpose part for general industries, and has not been designed or manufactured to be incorporated in a device or system used in purposes related to human life. Before using the product for special purposes such as nuclear power, electric power, aerospace, medicine or passenger movement vehicles, consult with Mitsubishi Electric. This product has been manufactured under strict quality control. However when installing the product where major accidents or losses could occur if the product fails, install appropriate backup or failsafe functions in the system. 	

1.1 Incorporated Items

Check to ensure the following product and items are included in the package.

Included Item	Quantity
FX3U-CAN	1 unit
Terminating resistor (120 Ω)	1 piece
Special unit/block No. label	1 sheet
Dust proof protection sheet	1 sheet
Manual (English version only)	1 manual

1.2 External Dimensions and Part Names

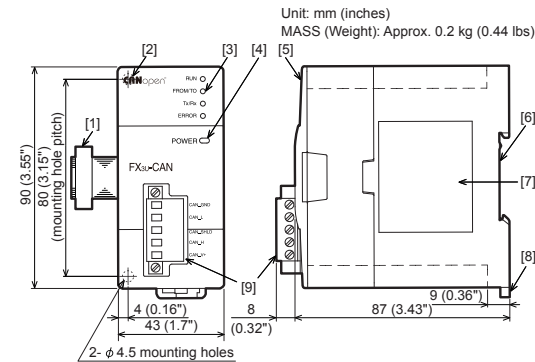

- | | |
|---|--|
| [1] Extension cable | [6] DIN rail mounting groove (DIN rail: DIN46277, 35 mm (1.38") width) |
| [2] Direct mounting hole (2 holes of φ 4.5 (0.18") (mounting screw: M4 screw) | [7] Nameplate |
| [3] Status LEDs (see section 1.3) | [8] DIN rail mounting hook |
| [4] Power LED (green) | [9] CAN bus connector |
| [5] Top cover | |

1.3 Power and status LEDs

LED Name	LED Color	Status	Description
RUN	Green	OFF	Layer-2 offline mode
		SINGLE FLASH ¹	CANopen® STOPPED state
		BLINKING ¹	CANopen® PRE-OPERATIONAL state
		FLICKERING ¹	LSS Services in progress
FROM/TO	Green	ON	• CANopen® mode: CANopen® OPERATIONAL state • Layer-2 mode: Layer-2 online mode
		OFF	PLC is not accessing BFMs in module.
Tx/Rx	Green	ON	Module is transmitting or receiving CAN messages.
		OFF	Module is not transmitting or receiving CAN messages.
ERROR	Red	OFF	No error
		SINGLE FLASH ¹	At least one of the error counters of the module has reached or exceeded the error passive level.
		DOUBLE FLASH ¹	A NMT guarding failure (NMT-Slave or NMT-Master) or a heartbeat failure has occurred.
		BLINKING ¹	General error
POWER	Green	ON	LSS Services in progress
		OFF	Module is BUS-OFF state, or CPU error occurs in PLC main unit.
POWER	Green	ON	24V DC power is properly supplied from PLC main unit.

¹ For details, refer to the following manual.

→ FX3U-CAN User's Manual

1.4 Terminal Layout

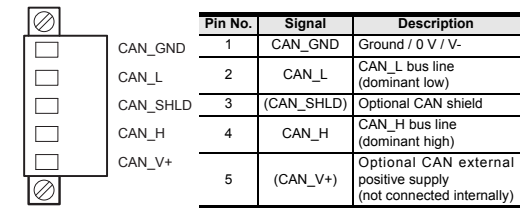

2. Installation

For installation details, refer to the following manual. → FX3U-CAN User's Manual

INSTALLATION PRECAUTIONS	 WARNING
<ul style="list-style-type: none"> Make sure to cut off all phases of the power supply externally before attempting installation or wiring work. Failure to do so may cause electric shock or damage to the product. 	

INSTALLATION PRECAUTIONS	 CAUTION
<ul style="list-style-type: none"> Use the product within the generic environment specifications described in PLC main unit manual (Hardware Edition). Never use the product in areas with excessive dust, oily smoke, conductive dusts, corrosive gas (salt air, Cl₂, H₂S, SO₂ or NO₂), flammable gas, vibration or impacts, or expose it to high temperature, condensation, or rain and wind. If the product is used in such conditions, electric shock, fire, malfunctions, deterioration or damage may occur. Do not touch the conductive parts of the product directly. Doing so may cause device failures or malfunctions. When drilling screw holes or wiring, make sure that cutting and wiring debris do not enter the ventilation slits. Failure to do so may cause fire, equipment failures or malfunctions. Be sure to remove the dust proof sheet from the PLC's ventilation port when installation work is completed. Failure to do so may cause fire, equipment failures or malfunctions. Install the product on a flat surface. If the mounting surface is rough, undue force will be applied to the PC board, thereby causing nonconformities. Install the product securely using a DIN rail or mounting screws. Connect extension cables securely to their designated connectors. Loose connections may cause malfunctions. 	

2.1 Connection with PLC

The FX3U-CAN connects on the right side of a PLC main unit or extension units/blocks (including special function units/blocks). For connection to an FX3GC/FX3UC Series PLC or FX2NC Series PLC extension block, an FX2NC-CNV-IF or FX3UC-1PS-5V is required. For connection to an FX5U/FX5UC PLC, an FX5-CNV-BUS or FX5-CNV-BUSC is required.

- For details, refer to the respective PLC manual.
 → Refer to the FX3G Series User's Manual - Hardware Edition
 → Refer to the FX3GC Series User's Manual - Hardware Edition
 → Refer to the FX3U Series User's Manual - Hardware Edition
 → Refer to the FX3UC Series User's Manual - Hardware Edition
 → Refer to the MELSEC IQ-F FX5U User's Manual (Hardware)
 → Refer to the MELSEC IQ-F FX5UC User's Manual (Hardware)

2.2 Mounting

The product is mounted by the following method.
 • DIN rail mounting
 • Direct mounting (mounting screw: M4 screw)
 For details, refer to the respective PLC manual.
 → Refer to the FX3G Series User's Manual - Hardware Edition
 → Refer to the FX3GC Series User's Manual - Hardware Edition
 → Refer to the FX3U Series User's Manual - Hardware Edition
 → Refer to the FX3UC Series User's Manual - Hardware Edition
 → Refer to the MELSEC IQ-F FX5U User's Manual (Hardware)
 → Refer to the MELSEC IQ-F FX5UC User's Manual (Hardware)

3. Wiring

For wiring details, refer to the following manuals. → FX3U-CAN User's Manual

WIRING PRECAUTIONS	 WARNING
<ul style="list-style-type: none"> Make sure to cut off all phases of the power supply externally before attempting installation or wiring work. Failure to do so may cause electric shock or damage to the product. 	

WIRING PRECAUTIONS **CAUTION**

- Perform class D grounding (grounding resistance: 100Ω or less) to the shield of the twisted shield cable (refer to subsection 3.2.3). Do not use common grounding with heavy electrical systems (refer to the manual of the PLC main unit).
- When drilling screw holes or wiring, make sure cutting or wire debris does not enter the ventilation slits. Failure to do so may cause fire, equipment failures or malfunctions.
- Install module so that excessive force will not be applied to communication connectors or communication cables. Failure to do so may result in wire damage/breakage or PLC failure.
- Make sure to affix the CAN bus connector with fixing screws. Tightening torque should follow the specifications in the manual. Loose connections may cause malfunctions.
- Make sure to properly wire to the terminal block (CAN bus connector) in accordance with the following precautions. Failure to do so may cause electric shock, equipment failures, a short-circuit, wire breakage, malfunctions, or damage to the product.
 - The disposal size of the cable end should follow the dimensions described in the manual.
 - Tightening torque should follow the specifications in the manual.
 - Twist the end of strand wire and make sure that there are no loose wires.
 - Do not solder-plate the electric wire ends.
 - Do not connect more than the specified number of wires or electric wires of unspecified size.
 - Affix the electric wires so that neither the terminal block nor the connected parts are directly stressed.
- Make sure to observe the following precautions in order to prevent any damage to the machinery or accidents due to abnormal data written to the PLC under the influence of noise:
 - Do not bundle the main circuit line together with or lay it close to the main circuit, high-voltage line or load line. Otherwise, noise disturbance and/or surge induction are likely to take place. As a guideline, lay the control line at least 100 mm (3.94") or more away from the main circuit or high-voltage lines.
 - Ground the shield wire or shield of a shielded cable. Do not use common grounding with heavy electrical systems (refer to the manual of the PLC main unit).
- Place the communication cable in grounded metallic ducts or conduits both inside and outside of the control panel whenever possible.

3.1 Applicable Cable and Connector

3.1.1 Applicable connector

FX3U-CAN uses a CAN bus connector. This connector is removable.

For removal and installation of the CAN bus connector, refer to the following section.

→ Refer to subsection 3.1.4

3.1.2 Applicable cable

Item	Applicable Cable
Cable Type	Twisted pair cable
Unshielded/Shielded	Shielded
No. of Pairs	2 pair
Conformance Standard	ISO 11898/1993
Wire Size	0.3 mm ² to 0.82 mm ² (AWG22 to 18) ¹
Impedance	120 Ω

¹ When bus length is long, use thicker wire. For details, refer to the following manual.

→ FX3U-CAN User's Manual

3.1.3 Termination of cable end

Strip 9 mm (0.35") of insulation from the end of the wire. In case of stranded wires, use wire ferrules. Refer to the following manual.

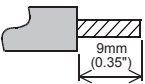

→ FX3U-CAN User's Manual

The tightening torque must be 0.4 to 0.5 N·m.

Do not tighten terminal screws with a torque outside the above-mentioned range. Failure to do so may cause equipment failures or malfunctions.

3.1.4 Removal and installation of CAN connector

- Removal**
Evenly unscrew both CAN connector mounting screws, and remove the CAN connector from the module. If the cable is attached to the connector, hold and pull the connector on the side. Do not pull the cable.
- Installation**
Place the CAN connector in the specified position, and evenly tighten both CAN connector mounting screws. Tightening torque 0.4 to 0.5 N·m. Do not tighten the terminal block mounting screws with a torque outside the above-mentioned range. Failure to do so may cause equipment failures or malfunctions.

3.2 CAN-Bus Wiring

3.2.1 Connecting communication cables

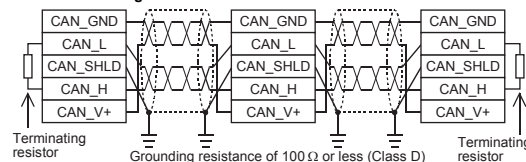

For electromagnetic compatibility (EMC), it is recommended to ground the cable shield at both ends.

Caution

For safety, always check the potential differences between the grounding points. If potential differences are found, proper measures must be taken to avoid damage.

3.2.2 Module wiring

For PLC wiring details, refer to the following manual.

- Refer to the **FX3G Series User's Manual - Hardware Edition**
- Refer to the **FX3GC Series User's Manual - Hardware Edition**
- Refer to the **FX3U Series User's Manual - Hardware Edition**
- Refer to the **FX3UC Series User's Manual - Hardware Edition**
- Refer to the **MELSEC IQ-F FX5U User's Manual (Hardware)**
- Refer to the **MELSEC IQ-F FX5UC User's Manual (Hardware)**

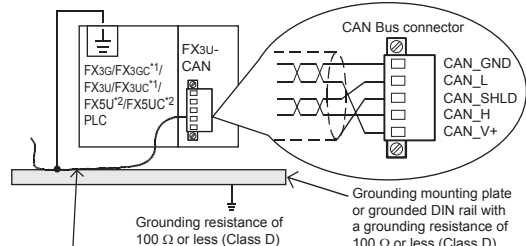

Strip a part of the coating of the shielded twisted pair cable as shown subsection 3.2.3. Ground the PLC's grounding terminal there.

- ¹ An FX2NC-CNV-IF or FX3UC-1PS-5V is necessary to connect the FX3U-CAN to an FX3GC/FX3UC Series PLC.
- ² An FX5-CNV-BUS or FX5-CNV-BUSC is necessary to connect the FX3U-CAN to an FX5U/FX5UC PLC.

3.2.3 Grounding of twisted pair cable

Strip a part of the coating of the shielded twisted pair cable as shown below, and ground at least 35 mm (1.38") of the exposed shield section.



3.2.4 Termination

The CANopen® network requires terminating resistors for both network ends. When FX3U-CAN is the network end, connect the included terminating resistor (120 Ω 1/2W) between pin number 2 (CAN_L) and 4 (CAN_H).

3.3 Grounding

For details, refer to the following manual.

→ FX3U-CAN User's Manual

4. Specifications

DESIGN PRECAUTIONS **WARNING**

- Make sure to have the following safety circuits outside of the PLC to ensure safe system operation even during external power supply problems or PLC failure. Otherwise, malfunctions may cause serious accidents.
 - Most importantly, have the following: an emergency stop circuit, a protection circuit, an interlock circuit for opposite movements (such as normal vs. reverse rotation), and an interlock circuit (to prevent damage to the equipment at the upper and lower positioning limits).
 - Note that when the PLC CPU detects an error, such as a watchdog timer error, during self-diagnosis, all outputs are turned off. Also, when an error that cannot be detected by the PLC CPU occurs in an input/output control block, output control may be disabled. External circuits and mechanisms should be designed to ensure safe machinery operation in such a case.
- For the operating status of each node in the case of a communication error, see the FX3U-CAN user's manual and the product manual of each node. Erroneous output or malfunctions may cause an accident.

DESIGN PRECAUTIONS **WARNING**

- When executing control (data changes) to an operating PLC, construct an interlock circuit in the sequence program so that the entire system operates safely. In addition, when executing control such as program changes and operation status changes (status control) to an operating PLC, thoroughly read the manual and sufficiently confirm safety in advance. Especially in control from external equipment to a PLC in a remote place, problems in the PLC may not be able to be handled promptly due to abnormality in data transfer. Construct an interlock circuit in the sequence program. At the same time, determine the actions in the system between the external equipment and the PLC for protection against abnormalities in data transfer.

DESIGN PRECAUTIONS **CAUTION**

- Make sure to observe the following precautions in order to prevent any damage to the machinery or accidents due to abnormal data written to the PLC under the influence of noise:
 - Do not bundle the main circuit line together with or lay it close to the main circuit, high-voltage line or load line. Otherwise, noise disturbance and/or surge induction are likely to take place. As a guideline, lay the control line at least 100 mm (3.94") or more away from the main circuit or high-voltage lines.
 - Ground the shield wire or shield of a shielded cable. Do not use common grounding with heavy electrical systems (refer to the manual of the PLC main unit).

STARTUP AND MAINTENANCE PRECAUTIONS **CAUTION**

- Do not disassemble or modify the PLC. Doing so may cause fire, equipment failures, or malfunctions. For repair, contact your local Mitsubishi Electric representative.
- Turn off the power to the PLC before connecting or disconnecting any extension cable. Failure to do so may cause equipment failures or malfunctions.
- Do not drop the product or exert strong impact to it. Doing so may cause damage.

DISPOSAL PRECAUTIONS **CAUTION**

- Please contact a certified electronic waste disposal company for the environmentally safe recycling and disposal of your device.

TRANSPORTATION AND STORAGE PRECAUTIONS **CAUTION**

- The PLC is a precision instrument. During transportation, avoid impacts larger than those specified in the general specifications of the PLC main unit manual by using dedicated packaging boxes and shock-absorbing pallets. Failure to do so may cause failures in the PLC. After transportation, verify operation of the PLC and check for damage of the mounting part, etc.

4.1 Applicable PLC

Model name	Applicability
FX3G Series PLC	Ver. 1.00 and later (Up to 8 blocks can be extended ²)
FX3GC Series PLC ¹	Ver. 1.40 and later (Up to 8 blocks can be extended ²)
FX3U Series PLC	Ver. 2.20 and later (Up to 8 blocks can be extended ²)
FX3UC Series PLC ¹	Ver. 2.20 and later (Up to 8 blocks can be extended ^{2,3})
FX5U PLC ^{4,5}	Ver. 1.031 and later (Up to 8 blocks can be extended ²)
FX5UC PLC ^{4,5}	Ver. 1.031 and later (Up to 8 blocks can be extended ²)

The version number can be checked by reading the last three digits of device D8001/D8101.

- ¹ An FX2NC-CNV-IF or FX3UC-1PS-5V is necessary to connect the FX3U-CAN to an FX3GC/FX3UC Series PLC.
- ² Check the current consumption of the connected extension blocks and insert extension power supply units if necessary.
- ³ Up to 7 units can be connected to the FX3UC-32MT-LT(-2) PLC.
- ⁴ An FX5-CNV-BUS or FX5-CNV-BUSC is necessary to connect the FX3U-CAN to an FX5U/FX5UC PLC.
- ⁵ Applicable for FX3UC-Firmware Ver. 1.12 and later.

4.2 General Specifications

Items other than the following are equivalent to those of the PLC main unit.

For general specifications, refer to the manual of the PLC main unit.

- Refer to the **FX3G Series User's Manual - Hardware Edition**
- Refer to the **FX3GC Series User's Manual - Hardware Edition**
- Refer to the **FX3U Series User's Manual - Hardware Edition**
- Refer to the **FX3UC Series User's Manual - Hardware Edition**
- Refer to the **MELSEC IQ-F FX5U User's Manual (Hardware)**
- Refer to the **MELSEC IQ-F FX5UC User's Manual (Hardware)**

Item	Specification
Dielectric Withstand Voltage	500V AC for one minute
Insulation Resistance	5MΩ or more by 500V DC insulation resistance tester

Between all terminals and ground terminal

4.3 Power Supply Specification

Item	Specification
Internal Power Supply	24V DC, max 110 mA 24V DC power is supplied internally from the main unit.

For details on the 24V DC power supply of main unit, refer to the manual of the PLC main unit.

4.4 Performance Specifications

Item	Specification
Transmission Type	CAN Bus network (RS-485, CSMA/CR)
Applicable Function	CANopen® Node, CAN Layer 2 Node
CANopen® Communication Services According to CiA® Standards	<ul style="list-style-type: none"> CiA® 301 V4.2 CiA® 302 V4.1 CiA® 305 V2.2
CANopen® Device and Application Profiles According to CiA® Standards	<ul style="list-style-type: none"> Interface and Device Profile CiA® 405 V2.0 for IEC 61131-3 Programmable Devices. Application Profile CiA® 417 V2.1 for lift control systems.
Remote Transmit Request (RTR)	No support in CANopen® mode. → For support in Layer 2 mode, refer to the FX3U-CAN User's Manual
Node Number on CANopen® Network	Maximum 127 nodes A total of 30 nodes can be connected to any segment of the bus. Using repeaters or bridges, the total number can be extended up to 127 nodes.
Node ID	Selectable from 1 to 127
Communication Method	Acyclic, cyclic or event driven
Supported Transmission Speed /Maximum Bus Length	1 Mbps / 25 m (82')
	800 kbps / 50 m (164')
	500 kbps / 100 m (328'1")
	250 kbps / 250 m (820'2")
	125 kbps / 500 m (1640'5")
Connection Cable	100 kbps / 600 m (1968'6")
	50 kbps / 1000 m (3280'10")
	20 kbps / 2500 m (8202'1")
Terminating Resistor	10 kbps / 5000 m (16404'2")
No. of Occupied I/O Points	Refer to subsection 3.1.2.
	120 Ω (Accessory: 120 Ω 1/2W)
	8 points (taken from either the input or output points of the PLC)

This manual confers no industrial property rights or any rights of any other kind, nor does it confer any patent licenses. Mitsubishi Electric Corporation cannot be held responsible for any problems involving industrial property rights which may occur as a result of using the contents noted in this manual.

Warranty

Exclusion of loss in opportunity and secondary loss from warranty liability
Regardless of the gratis warranty term, Mitsubishi shall not be liable for compensation to:
(1) Damages caused by any cause found not to be the responsibility of Mitsubishi.
(2) Loss in opportunity, lost profits incurred to the user by Failures of Mitsubishi products.
(3) Special damages and secondary damages whether foreseeable or not, compensation for accidents, and compensation for damages to products other than Mitsubishi products.
(4) Replacement by the user, maintenance of on-site equipment, start-up test run and other tasks.

For safe use

- This product has been manufactured as a general-purpose part for general industries, and has not been designed or manufactured to be incorporated in a device or system used in purposes related to human life.
- Before using the product for special purposes such as nuclear power, electric power, aerospace, medicine or passenger movement vehicles, consult with Mitsubishi Electric.
- This product has been manufactured under strict quality control. However when installing the product where major accidents or losses could occur if the product fails, install appropriate backup or failsafe functions in the system.

MITSUBISHI ELECTRIC CORPORATION

HEAD OFFICE : TOKYO BUILDING, 2-7-3 MARUNOUCHI, CHIYODA-KU, TOKYO 100-8310, JAPAN