

MITSUBISHI

A1SJ72QLP25/A1SJ72QBR15 MELSECNET/10 Remote I/O Module

User's Manual (Hardware)

Thank you for buying the Mitsubishi General Use PC MELSEC-QnA Series. Before use, please read this manual carefully and correctly operate the module with a sufficient understanding of the QnA series PC functions and performance. Please place this manual in a location where it is available to end users.



MODEL	A1SQLP25QBR15UHWE
MODEL CODE	13J899

IB-66751-A (9702) MEE

● SAFETY PRECAUTIONS ●

(Read these precautions before using.)

When using Mitsubishi equipment, thoroughly read this manual and the associated manuals introduced in this manual. Also pay careful attention to safety and handle the module properly.

These precautions apply only to Mitsubishi equipment. Refer to the CPU module user's manual for a description of the PC system safety precautions.

These ● SAFETY PRECAUTIONS ● classify the safety precautions into two categories: "DANGER" and "CAUTION"

 **DANGER**

Procedures which may lead to a dangerous condition and cause death or serious injury if not carried out properly.

 **CAUTION**

Procedures which may lead to a dangerous condition and cause superficial to medium injury, or physical damage only, if not carried out properly.

Depending on circumstances, procedures indicated by  **CAUTION** may also be linked to serious results.

In any case, it is important to follow the directions for usage.

Store this manual in a safe place so that you can take it out and read it whenever necessary. Always forward it to the end user.

[Design precautions]

DANGER

- When there are communication problems with the data link, the communication problem station will enter the following condition. Build an interlock circuit into the sequence program that will make sure the system operates safely by using the communication state information. Not doing so could result in erroneous output or erroneous operation.

(1) For the data link data, the data prior to the communication error will be held.

(2) The remote I/O station will turn all output off.

However, when the output hold is set for the Q4ARCPU (for the independent system) and A6RAF (for the duplex system), the output state prior to the communication error is maintained. When using a module that has a function of outputting externally via a remote I/O station, be careful.

CAUTION

- Do not bunch the control wires or communication cables with the main circuit or power wires, or install them close to each other.

They should be installed 100mm (3.9 inch) or more from each other.

Not doing so could result in noise that would cause erroneous operation.

[Installation precautions]

CAUTION

- Use the PC in an environment that meets the general specifications contained in this manual. Using this PC in an environment outside the range of the general specifications could result in electric shock, fire, erroneous operation, and damage to or deterioration of the product.
- Insert the tabs at the bottom of the module into the mounting holes in the base module, then tighten the module screws with the specified torque. If the module is not properly secured with screws, it may result in malfunctions, breakdowns, or the module may fall off.
- Do not directly touch the module's conductive parts or electronic components. Doing so could cause malfunction or trouble in the module.

[Wiring precautions]

DANGER

- Switch all phases of the external power supply off when installing or placing wiring. Not doing so could result in electric shock or damage the product.



CAUTION

- Be sure there are no foreign substances such as sawdust or wiring debris inside the module. Such debris could cause fires, damage, or erroneous operation.
- Solder the coaxial cable connector properly. Incomplete soldering may cause a malfunction.
- Install the connector securely to the module.
- Do not pull the module when the MELSECNET/10 connection cable is connected to the module. This may result in damages to the module and cable.

[Starting and maintenance precautions]



DANGER

- Do not touch the connector while the power is on. Doing so could cause erroneous operation.
- Switch all phases of the external power supply off before cleaning or re-tightening terminal screws. Not doing so could cause failure or malfunction of the module.



CAUTION

- Before conducting operations such as changing the program while the module is operating, force output, run, stop, pause, etc., be sure to thoroughly read the manual and take due consideration for safety. Operation mistakes could cause damage to the equipment and other problems.
- Do not disassemble or modify the modules. Doing so could cause trouble, erroneous operation, injury, or fire.
- Switch all phases of the external power supply off before mounting or removing the module. Not doing so could cause failure or malfunction of the module.

[Disposal precautions]



CAUTION

- When disposing of this product, treat it as industrial waste.

About the Manual

The following product manuals are available. Please use this table as a reference to request the appropriate manual as necessary.

Manual Name	Manual No. (Model Code)
For QnA/Q4AR MELSECNET/1Q Network System Reference Manual	IB-66690 (13JF78)
Type SW0IVD-GPPQ GPP Software Package OPERATING MANUAL (Offline)	IB-66623 (13JF12)
Type SW0IVD-GPPQ GPP Software Package OPERATING MANUAL (Online)	IB-66624 (13JF13)
Type SW1IVD-GPPQ GPP Software Package OPERATING MANUAL (Offline)	IB-66736 (13J917)
Type SW1IVD-GPPQ GPP Software Package OPERATING MANUAL (Online)	IB-66737 (13J918)
SW2IVD-GPPA GPP Function Software Package Operating Manual (GPP)	IB-66506 (13JE73)
SW3IVD-GPPA GPP Function Software Package Operating Manual (Supplement)	BCN-85834
SW3IVD-GPPA GPP Function Software Package Operating Manual (GPP)	IB-66691 (13J906)
A6GPP/A6PHP (SW1GP-GPPAUJE USE) Operating Manual	IB-66704 (13JF36)
A6GPP/A6PHP (SW4GP-GPPA USE) Operating Manual	IB-66259 (13J717)

Information When Reading the QnA/Q4AR MELSECNET/10 Network System Reference Manual

When using the A1SJ72QLP25 or A1SJ72QBR15, read the QnA/Q4ARCPU MELSECNET/10 Network System Reference Manual (SH-3585), which is sold separately, in addition to this manual, which is a part of the product package.

If the A1SJ72QLP25 and A1SJ72QBR15 are not described in your QnA/Q4ARCPU MELSECNET/10 Network System Reference Manual, please refer to AJ72QLP25 and AJ72QBR15 as A1SJ72QLP25 and A1SJ72QBR15, respectively.

The functions and specifications of A1SJ72QLP25 and A1SJ72QBR15 are same as those of AJ72QLP25 and AJ72QBR15, respectively, except for the external dimensions, LED display contents, weight, and current consumption.

For the external dimensions, LED display contents, weight, and current consumption, please read this manual, which is a part of the product package.

Table of Contents

SAFETY PRECAUTIONS

About the Manual

Information When Reading the QnA/Q4AR MELSECNET/10 Network System Reference Manual

1	Overview	1
2	System Configuration	2
2.1	System Configuration.....	2
2.2	Precautions When Configuring the System	3
3	Performance Specifications	4
4	Setting and Procedures Before System Operation	6
4.1	Procedure Before System Operation	6
4.2	Part Names and Settings	7
4.3	LED Display Details	9
4.4	Connection	11
4.4.1	Optical loop system	11
4.4.2	Coaxial bus system.....	13
4.5	Offline Test (Module Check).....	16
4.5.1	Hardware Test (Test Mode 7).....	17
4.5.2	Internal Self Loopback Test (Test Mode 6)....	19
4.5.3	Self Loopback Test (Test Mode 5).....	21
5	Handling Precautions	23
6	Maintenance and Inspection	24
7	External Dimension Diagram	25

1 Overview

This manual gives the specifications and name of parts for the A1SJ72QLP25/A1SJ72QBR15 type network modules to be used in a MELSEC-QnA series MELSECNET/10 network system.

- (1) The following table shows the applications, applicable cable and installation position of the A1SJ72QLP25 and A1SJ72QBR15.

	Application	Applicable Cable		Module Installation Position
		Optical Fiber Cable	Coaxial Cable	
A1SJ72QLP25	For remote I/O stations of MELSECNET/10	○	—	CPU slot of main base
A1SJ72QBR15		—	○	

- (2) Please confirm that the following parts have been supplied on unpacking the package:

- (a) A1SJ72QLP25

Part Name	Quantity
A1SJ72QLP25 remote I/O module	1

- (b) A1SJ72QBR15

Part Name	Quantity
A1SJ72QBR15 remote I/O module	1
F type connector (A6RCON-F)	1

- (3) When configuring a coaxial bus system a terminal resistor (A6RCON-R75) must be installed at both ends. The terminal resistors are not contained in the package and you must be obtained at your own expense.

2 System Configuration

2.1 System Configuration

The system configuration with the MELSECNET/10 remote I/O network is shown below (the example shown is a two-layer system):

(1) Optical loop system

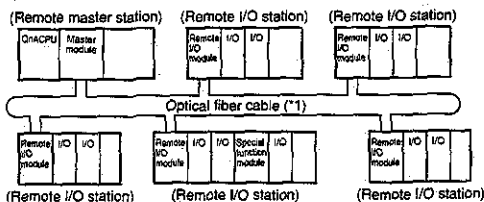

(2) Coaxial bus system

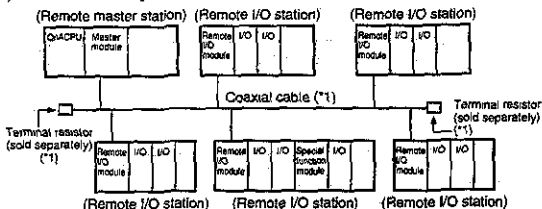

*1

	Optical loop system	Coaxial bus system	Remarks
Link cable	<ul style="list-style-type: none"> • SI cable (Old type) H type (station-to-station distance: maximum 300 m (984.3 ft.)) L type (station-to-station distance: maximum 500 m (1640.5 ft.)) • SI cable (station-to-station distance: maximum 500 m (1640.5 ft.)) • QSI cable (station-to-station distance: maximum 1 km) 	<ul style="list-style-type: none"> • 3C-2V (station-to-station distance: maximum 300 m (984.3 ft.)) • 5C-2V (station-to-station distance: maximum 500 m (1640.5 ft.)) 	Arranged by individual user
Terminal resistor	—	A6RCON-R75 or BNC-TMP-05 (75)	
F type connector	—	A6RCON-F	Synchronous to the module

The BNC-TMP-05 (75) terminal resistor is manufactured by Hirose Electronics, Ltd.

2.2 Precautions When Configuring the System

The cautions regarding the system configurations when using the MELSECNET/10 remote I/O module is described below.

(1) Combination of the remote master station and PC CPU

Listed below are the combinations of the master station and master station PC CPU's which allow a system configuration to establish the MELSECNET/10 remote I/O network using the remote I/O modules described in this manual.

Master station PC CPU (software version)	Master station network module (software version)
Q2ACPU, Q2ACPU-S1 Q3ACPU, Q4ACPU Q4ARCPU	AJ71QLP21 (*1) AJ71QBR11 (*1) AJ71QLP21S (*1)
Q2ASCPU, Q2ASCPU-S1 Q2ASHCPU, Q2ASHCPU-S1	A1SJ71QLP21 (H or later) A1SJ71QBR11 (H or later)
A2UCPU (N or later), A2UCPU-S1 (N or later) A3UCPU (N or later), A4UCPU (N or later)	AJ71LP21 (J or later) AJ71BR11 (J or later)
A2USCPU (D or later), A2USCPU-S1 (D or later)	A1SJ71LP21 (J or later) A1SJ71BR11 (J or later)

*1 When using in combination with the Q4ARCPU, use the network module whose software version is "H" or later.

(2) Supported GPP function software packages

Listed below are the GPP function software packages that can be used when performing monitoring operations by connecting a GPP function peripheral device to the remote I/O module described in this manual.

Master station PC CPU type	Peripheral device	Software package model
QnACPU	DOS/V personal computer	SW01VD-GPPQ GPP function software package SW11VD-GPPQ GPP function software package
AnUCPU	DOS/V personal computer	SW21VD-GPPA GPP function software package SW31VD-GPPA GPP function software package
	A6GPP	SW11GP-GPPAU GPP function software package
	A6PHP	

* DOS/V is a trademark of IBM Japan, Ltd.,

(3) Interruption modules, data link modules and other network modules cannot be installed to the remote I/O station. Refer to the reference manual for more details.

3 Performance Specifications

The following table shows the performance specifications of the A1SJ72QLP25 and A1SJ72QBR15.

Item		A1SJ72QLP25	A1SJ72QBR15
		Optical Loop System	Coaxial Bus System
Maximum number of link points per network	X/Y	8192 points	
	B	8192 points	
	W	8192 points	
Maximum number of link points per station		<ul style="list-style-type: none"> • Remote master station/remote submaster station → Remote I/O station $\left(\frac{Y+B}{8} + (2 \times W) \right) \leq 1600 \text{ bytes}$	
		<ul style="list-style-type: none"> • Remote I/O station → Remote master station/remote submaster station $\left(\frac{X+B}{8} + (2 \times W) \right) \leq 1600 \text{ bytes}$	
		<ul style="list-style-type: none"> • Remote master station → Remote sub master station Remote sub master station → Remote master station $\left(\frac{Y+B}{8} + (2 \times W) \right) \leq 2000 \text{ bytes}$	
Max. number of I/O points per station		$X + Y \leq 2048$ (main base plus 3 extension base)	
Communication speed		10 MBPS (20 MBPS: multiple transmission)	10 MBPS
Communication method		Token-ring method	Token bus method
Synchronization system		Frame synchronization	
Coding system		NRZI coding (Non Return to Zero Inverted)	Manchester coding
Transmission channel type		Duplex loop	Single bus
Transmission format		Conforms to HDLC (frame format)	
Maximum number of networks		239	
Number of stations connectable per network		65 stations (master station: 1; remote I/O station: 64)	33 stations (master station: 1; remote I/O station: 32)

(To the next page.)

Item	A1SJ72QLP25	A1SJ72QBR15	
	Optical Loop System	Coaxial Bus System	
Overall extension distance	30 km (98400 ft.) SI cable: station-to-station distance 500 m (*1) QSI cable: station-to- station distance 1 km	3C-2V	5C-2V
		300 m (984ft.) (station-to- station distance 300 m) (*2)	500 m (1640ft.) (station-to- station distance 500 m) (*2)
		Repeater module Extension up to 2.5 km possible by using A6BR10 or A6BR10-DC	
Error control system	Retry by CRC ($X^{16} + X^{12} + X^5 + 1$) and overtime		
RAS function	<ul style="list-style-type: none"> • Loopback function in response to error detection and cable disconnection (Optical loop system only) • Diagnosis function for local station link line check • Error detection using special relays and registers • Network monitor and other diagnosis functions 		
Transient transmission	• Monitoring with peripheral device, program up/download		
Connection cable	SI-200/220, QSI-185/230	3C-2V, 5C-2V or equivalent	
Applicable connector	2-core optical fiber cable connector plug CA7003	BNC connector compatible with 3C-2V, 5C-2V cable	
Cable transmission loss	12 dB/km or less 5.5 dB/km or less	Conforms to JIS C 3501	
Current consumption (5 VDC)	0.52 A	0.7 A	
Weight kg (lb)	0.41 (0.90)	0.43 (0.95)	

For general specifications, refer to the User's Manual for the PC CPU module used for the network system.

*1 The conventional optical fiber cable (A-2P-□□□) can be used up to 500m (1640.5ft.) for station-to-station connection with type L, and 300m (984.3ft.) for type H.

*2 For the coaxial bus system, there are some restrictions as shown below on the cable length between stations depending on the number of stations connected.

Number of stations connected	Station to station cable length	Total extension distance
2 to 9 stations	1 to 300m (3.281 to 984.3ft.) (3C-2V)	300m (984.3ft.) (3C-2V) 500m (1640.5ft.) (5C-2V)
	1 to 500m (3.281 to 1640.5ft.) (5C-2V)	
10 to 33 stations	1 to 5m (3.281 to 16.4ft.) (3C-2V, 5C-2V)	300m (984.3ft.) (3C-2V) 500m (1640.5ft.) (5C-2V)
	13 to 17m (42.65 to 55.8ft.) (3C-2V, 5C-2V)	
	25 to 300m (82.03 to 984.3ft.) (3C-2V)	
	25 to 500m (82.03 to 1640.5ft.) (5C-2V)	

4 Setting and Procedures Before System Operation

This chapter describes the procedures, setting, connections, and testing to perform data link.

4.1 Procedure Before System Operation

The procedure to perform data link is shown in the following flowchart below:

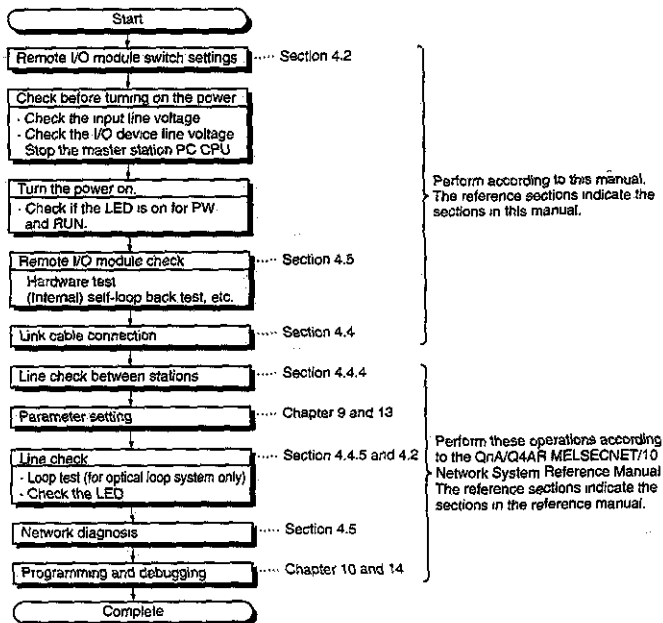

4.2 Part Names and Settings

Name of each part and the setting for the A1SJ72QLP25 and A1SJ72QBR15 are shown below:

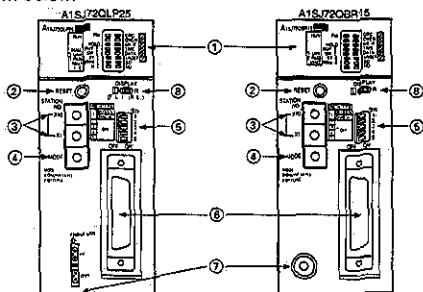

No.	Name	Description	Setting when shipped out	Section for detailed description	
①	—	Display LED	Displays the module and link status.	—	Section 4.3
②	RESET	Reset switch	Press to reset the local station. (Hardware reset)	—	—
③	STATION NO.	Station number setting switch (*1)	Set the local station number (1 to 64). x10: Second digit x1: First digit * When there is a setting error, the SW, E, LED turns on.	01	—
④	MODE	Mode setting switch (*1)	Sets the local station operation mode.	0	(1) in this section
⑤	SW	DIP switch	Sets the local operation condition when the power is off.	All off	(2) in this section
⑥	—	RS-422 interface	Connector to a GPP (function peripheral) device. (Refer to Section 2.2 (2) for connectable peripheral devices.)	—	—
⑦	—	Connector	Connector to the MELSECNET/10 network system.	—	Section 4.5
⑧	DISPLAY	LED display switch	Switches the display LED.	L side	Section 4.3

*1 When the setting is changed while the remote I/O station power is on, the changed details become valid by resetting the local station using the reset switch (2).

(1) Settings of the mode setting switches

Mode	Name	Description	Mode	Name	Description
0	Online (Auto recovery)	Auto recovery with data link.	7	Test mode 5	Self loopback test
1	Setting not possible	(The SW, E LED turns on when setting.)	8	Test mode 6	Internal self loopback test
2	Offline	Sets the local station offline.	9	Test mode 7	Hardware test
3	Test mode 1	Forward loop test	A 10 F	Setting not possible	—
4	Test mode 2	Reverse loop test			
5	Test mode 3	Station-to-station test (master)			
6	Test mode 4	Station-to-station test (slave)			

*1 Cannot set with a coaxial bus system. When this is set, the SW, E LED turns on.

(2) DIP switch setting

Sets the DIP switch when the local station remote I/O station power is off.

SW	Details
1	Set the operation condition of the local station (type of the GPP function peripheral device to connect to the local station). (*1) ON: GPPA or GPPAU peripheral device is connected. (Communication with the local station and PC CPU's other than remote station QnACPU can be performed.) OFF: GPPQ peripheral device is connected. (Communication with the local station and remote QnACPU can be performed.)
2	
3	Make sure the setting is OFF (ON: setting disable)
4	

*1 About the "SW1" DIP switch

- (a) When the local master station is the AnUCPU type, it can be treated as the AnU remote I/O station by turning on SW1.
However, communications with the QnACPU remote master station cannot be performed with this setting.

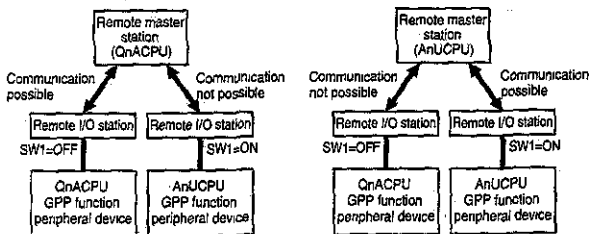

- (b) When connecting a GPP function peripheral device to the remote I/O station (local), set the local station PC CPU as follows:
When SW1 is on
(GPPA or GPPAU peripheral device is connected): A3U
When SW1 is off
(GPPQ peripheral device is connected): Q2AS (H) S1

Caution

Do not operate with the DIP switch on the printed board at the base installation side of the module. (Sets to OFF)

4.3 LED Display Details

The details of the displayed LED's for the A1SJ72QLP25 and A1SJ72QBR15 are described.

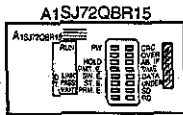
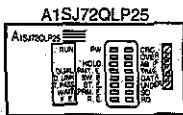

LED name	LED yes/no		LED display switch	Display during online		Display when normal	
	QLP	QBR		When on	When off		
RUN	○	○	Valid at L side ¹	Module normal	Module error (including the WDT error)	On	
DUAL	○	×		Multiple transmission in progress	Multiple transmission not executed	—	
D.LINK	○	○		Data link in progress (*1)	Data link stopped	—	
T.PASS	○	○		Transient transmission is possible. (*1)	Transient transmission not possible	On	
WAIT	○	○		Waiting for communication with special function module	No wait for communication with the special function module	—	
FE.	○	×	Valid at R side	Forward loop error (*1)	Forward loop normal	Off	
PW	○	○		Normal power supply from power module	Abnormal power supply from power module	On	
HOLD	○	○		Q4AR output in hold mode	Q4AR output in reset mode	—	
RMT.E.	○	○		Error (*2)	No error	Off	
SW.E.	○	○		Switch setting error (*1)	No switch setting error	Off	
STE.	○	○		Station number setting error (*1)	Station number setting normal	Off	
PRM.E.	○	○		Parameter setting error (*1)	No parameter setting error	Off	
R.E.	○	×		Reverse loop error (*1)	Reverse loop normal	Off	
CRC	○	○		QLP L: Forward loop state	Data link error (*1)	Data link normal	Off
OVER	○	○			R: Reverse loop state		
AB.JF	○	○	QBR Valid at both L and R sides				
TIME	○	○					
DATA	○	○					
UNDER	○	○					
SD	○	○		Data being transmitted (dim illumination)	Data not being transmitted	—	
RD	○	○		Data being received (dim illumination) (*3)	Data not received	—	

About the "LED yes/no" column

- The QLP and QBR columns indicate the module types. QLP: A1SJ72QLP25 QBR: A1SJ72QBR15
- The O/X indicates whether the LED exists. ○: Exists X: Does not exist

*1 The details of the error cause when the error is displayed is shown on the next page.

*2 Turns on when a blown fuse or I/O verification error occurs at the local station. (Confirm with special registers D9100 to D9123.)

*3 When there is no terminal resistors on the A1SJ72QBR15, the illumination may always be on even if the data link is not performed. (This is not an error with the remote I/O module.)

This section describes the LEDs indicating error occurrence during the data link execution.

Display	Error detection status	Description
RUN	Off	Network module hardware error has occurred.
D.LINK	Off	Cyclic transmission is stopped due to the data link stop from peripheral device or on-line test execution. (This is not an error.) When T.PASS is turned off.
T.PASS	Off	It is not able to perform cyclic or transient transmission because it cannot participate in the baton pass. The communication has been suspended due to line error.
F.E. R.E.	On	If the F.E. side is illuminated, there is an error in the forward loop line, such as turned-off power supply of adjacent station which is sending to the host, hardware error in the forward-loop sending section of the adjacent station, forward-loop data link cable is disconnected, or hardware error in the forward-loop receiving section of the host. If the R.E. side is illuminated, there is an error in the reverse loop line, such as turned-off power supply of adjacent station which is sending to the host, hardware error in the reverse-loop sending section of the adjacent station, reverse-loop data link cable is disconnected, or hardware error in the reverse-loop receiving section of the host.
SW.E	On	Station number setting switch is set to other than 1 to 64. Mode setting switch is set to unusable.
ST.E.	On	Station number or control station setting is overlapping on the same network.*1
PR.M.E.	On	I/O allocation to the remote I/O station is abnormal. The number of B/W points for handshaking to a special function module is insufficient. The contents of parameters received from the remote master station is abnormal.
CRC	On	An error caused by cable damage or noise.
OVER	On	Data was received before the previous receiving data was received internally, and the previous data was erased. There is a hardware error in the receiving section of network module.
AB.IF	On	Receiving data length is shorter than specified length, or the number of continuous "1" bits in the frame of receiving data exceeds the regulated value. Watchdog time is too short; there is a cable damage or noise, etc.
TIME	On	The baton was not passed to the host within watchdog time. Watchdog time is too short; there is a cable damage or noise, etc.
DATA	On	An error-code data was received. There is a cable damage, noise, etc.
UNDER	On	Internal processes for sending data were not performed with constant intervals. There is a hardware error in the sending section of network module.

*1 Even if the station numbers overlap, the ST. E. LED may not turn on depending on the line status and cable connection status. Confirm by visual inspection and the verify setting function of the online diagnosis.

4.4 Connection

4.4.1 Optical loop system

(1) Precaution when connecting

- (a) The optical fiber cable type that can be used differs depending on the station to station distance.

Cable type		Station to station distance
SI cable (old type)	H type	to 300m (984.3ft.)
	L type	to 500m (1641ft.)
SI cable		to 500m (1641ft.)
QSI cable		to 1km

- (b) When connecting the optical fiber cable, there are restrictions on cable bending diameter.

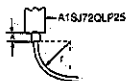

Cable type		Allowable bending radius r[mm]	Connector A[mm]	
			CA9003	CA7003
SI (old)	Standard for indoor use	50	45	—
	Reinforcement for indoor use	85		
	Standard for outdoor use	85		
	Reinforcement for outdoor use	140		
SI	Standard for indoor use	50	—	30
	Reinforcement for indoor use	60		
	Standard for outdoor use	60		
	Reinforcement for outdoor use	110		
QSI	Indoor use	50	—	30
	Reinforcement for indoor use	60		
	Standard for outdoor use	60		
	Reinforcement for outdoor use	140		

- (c) When cabling the optical fiber cable, do not touch the optical fiber core area of the cable connector or module connector, or do not allow any dust particles to form around the core area. If oil from the hand, or dust particles form on the core, the transmission loss is increased and the data link errors may result.
- (d) When connecting/disconnecting the optical fiber cable, do so by holding the cable connector area directly with your hand.
- (e) For the cable connector and module connector connection, make sure the connection "snaps" into place.

(2) Remote I/O network connection

The optical fiber cable is connected in the following manner:

The connection does not have to be performed in the order of station numbers:

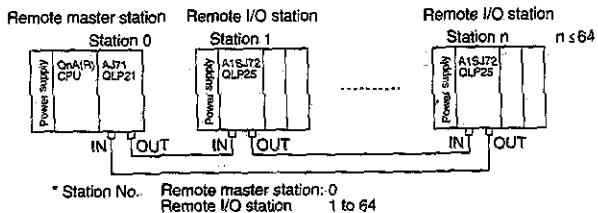

Point

If the station that is to be connected in the future (station included in the station count, but not actually connected) is set as a reserved station, a communication error does not occur at the station, and does not affect the link scan time.

4.4.2 Coaxial bus system

(1) Precaution when connecting

(a) Station to station cable length restriction

- 1) The cable to connect between remote I/O modules must be the following according to the number of stations connected.

When a cable length other than those specified in the table below is used, a communication error may result.

Number of stations connected	Station to station cable length	Total extension distance
2 to 9 stations	1 to 300m (3.281 to 984.3ft.) (3C-2V) 1 to 500m (3.281 to 1640.5ft.) (5C-2V)	
10 to 33 stations	1 to 5m (3.281 to 16.4ft.) (3C-2V, 5C-2V) 13 to 17m (42.65 to 55.8ft.) (3C-2V, 5C-2V) 25 to 300m (82.03 to 984.3ft.) (3C-2V) 25 to 500m (82.03 to 1640.5ft.) (5C-2V)	300m (984.3ft.) (3C-2V) 500m (1640.5ft.) (5C-2V)

- 2) If there is a possibility that the number of stations may increase due to system extensions, etc., perform the cabling by considering the restrictions.
- 3) When A6BR10/A6BR10-DC repeater modules are used, use the station to station cable length specified in "10 to 33 stations" regardless of the number of connected stations or number of repeater modules.

(b) Precaution when cabling

- 1) Wire the coaxial cable at least 100mm (3.94inch) away from other power cables and control cables.
- 2) Consider using the doublelayered shield coaxial cable for areas with more frequent noise.

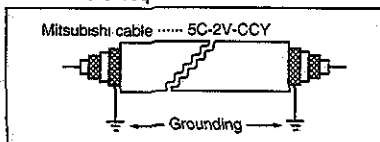

Double-layered shielded coaxial cable

- (c) When connecting a coaxial cable, there are restrictions on the cable bending radius.

Cable type	Allowable bending radius r [mm] (inch)	Connector A [mm] (inch)
3C-2V	23 (0.91)	50 (1.97)
5C-2V	30 (1.19)	

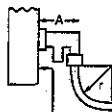

Front of module

- (d) Do not tug on the connected coaxial cable.

This may cause bad connections, loose cables, or module damage.

(2) Remote I/O network connection

The coaxial cable is connected in the following manner:

Be sure to connect terminal resistors (sold separately: A6RCON-R75) for both ends.

The F shaped connector is connected to the module.

(a) No repeater module

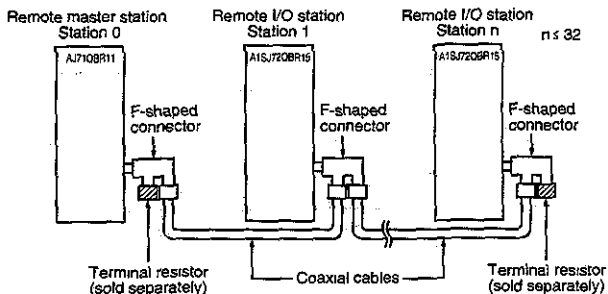

(b) Repeater module used (direct connection)

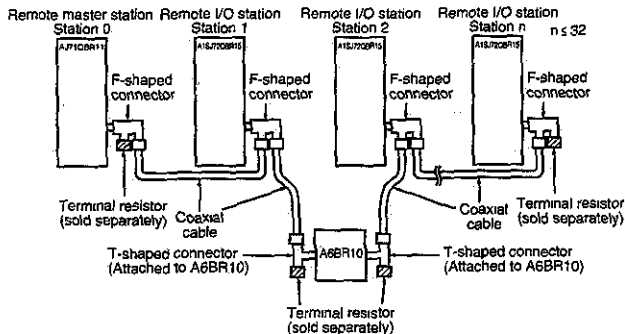

Remark

Refer to the user's manual included in the product for the details of repeater module(A6BR10).A6BR10/A6BR10-DC MELSECNET/10 Coaxial Bus System Repeater Module User's Manual IB-66499

(c) Repeater module used (mid branch connection)

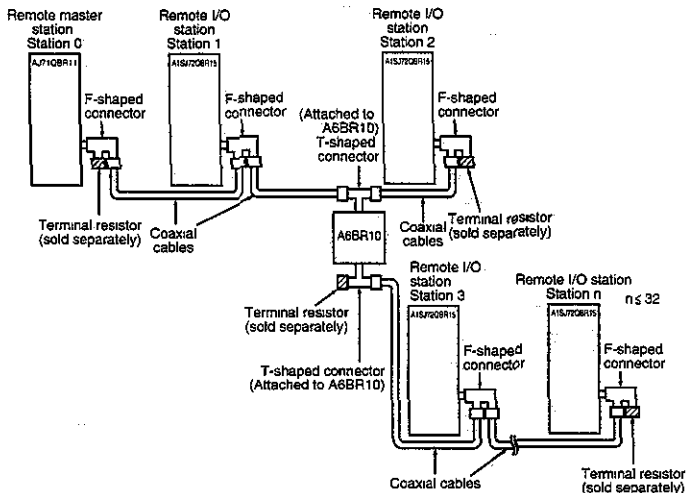

Points

- (1) If the station that is to be connected in the future (station included in the station count, but not actually connected) is set as a reserved station, a communication error does not occur for the station, and does not affect the link scan time.
- (2) The terminal resistor can be connected to either side of the F shaped connector.

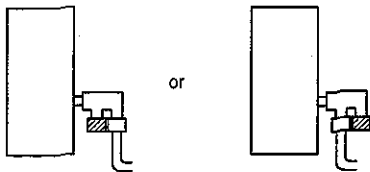

4.5 Offline Test (Module Check)

The remote I/O module and cable are checked before performing a data link. The test items are set with the mode setting switch located at the remote I/O module front surface.

[Test procedure]

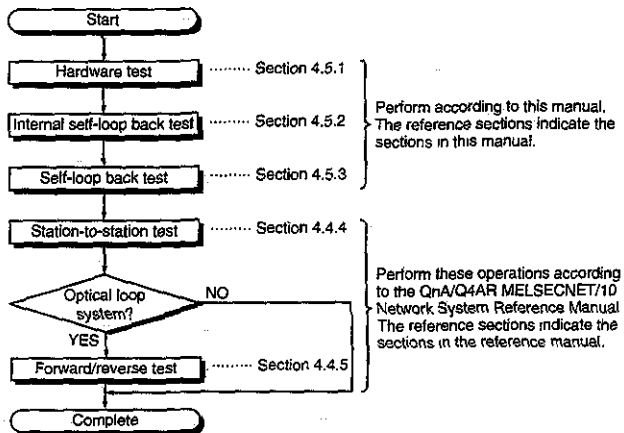

Point

When even one station is switched to test mode (mode setting switches: 3 to 9) during data link (online), a normal data link cannot be performed.

4.5.1 Hardware Test (Test Mode 7)

The hardware of the module is checked.

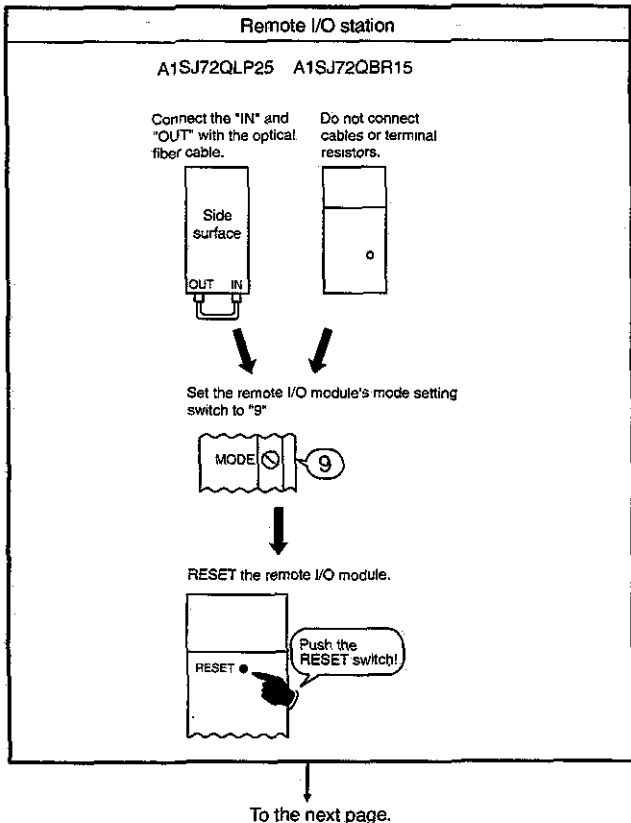

From the previous page.

Hardware testing in progress!

The test results are indicated on the LED.

<When normal>

The CRC → OVER → AB.IF → TIME → DATA → UNDER LED turn on in order. When this sequence repeats over five times, the system is normal.

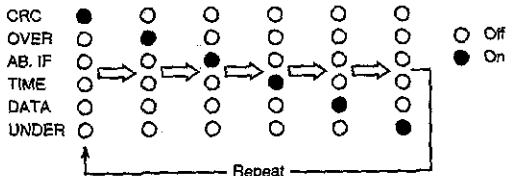

<When there is an error>

Same for optical loop system (A1SJ72QLP25) and coaxial bus system (A1SJ72QBR15)

When the following error occurs, the corresponding LED turns on, so replace the module.

- ① CRC turns onROM check error
- ② OVER turns onRAM check error
- ③ AB.IF turns on Timer/interrupt function check error

For optical loop system (A1SJ72QLP25) only

- ① TIME turns on Forward loop luminous energy check error
- ② DATA turns on Reverse loop luminous energy check error

When there is a luminous energy check error, determine the erroneous area using the following flowchart:

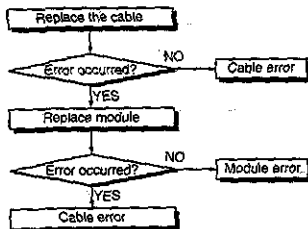

4.5.2 Internal Self Loopback Test (Test Mode 6)

This checks the hardware including the transmission system's transmission/receiving circuits of the individual module.

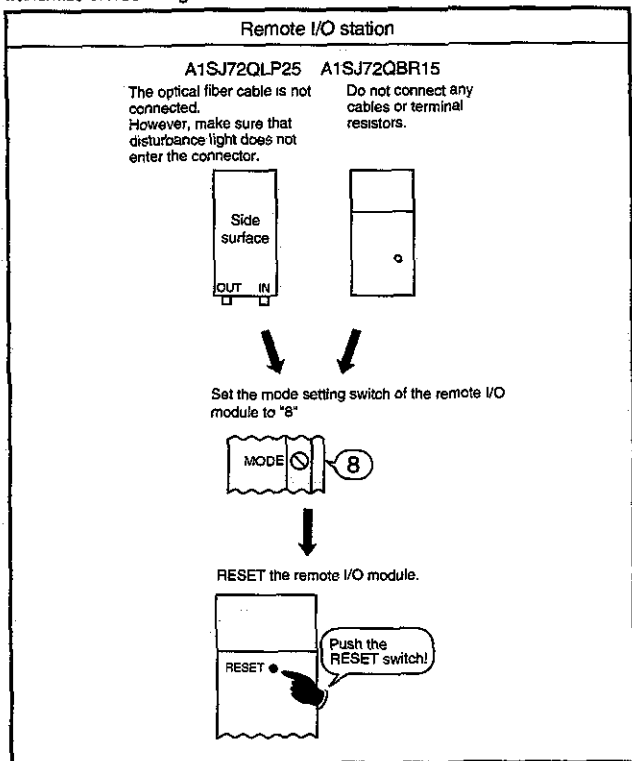

To the next page.

From the previous page.

Internal self loopback test in progress!

The test results are indicated on the LED.

<When normal>

The CRC → OVER → AB.IF → TIME → DATA → UNDER LED turn on in order. When this sequence repeats over five times, the system is normal.

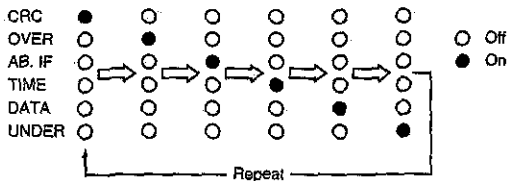

<When there is an error>

In case of the optical loop system (A1SJ72QLP25)

When the following error occurs, the corresponding LED turns on, so replace the module.

① ERROR LED turns on...hardware error

In case of the coaxial bus system (A1SJ72QBR15)

① ERROR LED turns on...hardware error

Remark

When an error occurs in the coaxial bus system, LEDs other than ERROR LED (CRC, OVER, AB.IF, TIME, DATA, UNDER) may turn on, such as S.T.E. and PRM.E. Report the LED status when requesting module fixing.

4.5.3 Self Loopback Test (Test Mode 5)

This checks the hardware including the transmission system's transmission/receiving circuits of the individual module in order to judge the cable conditions when the internal self-loop back testing ended without any problem.

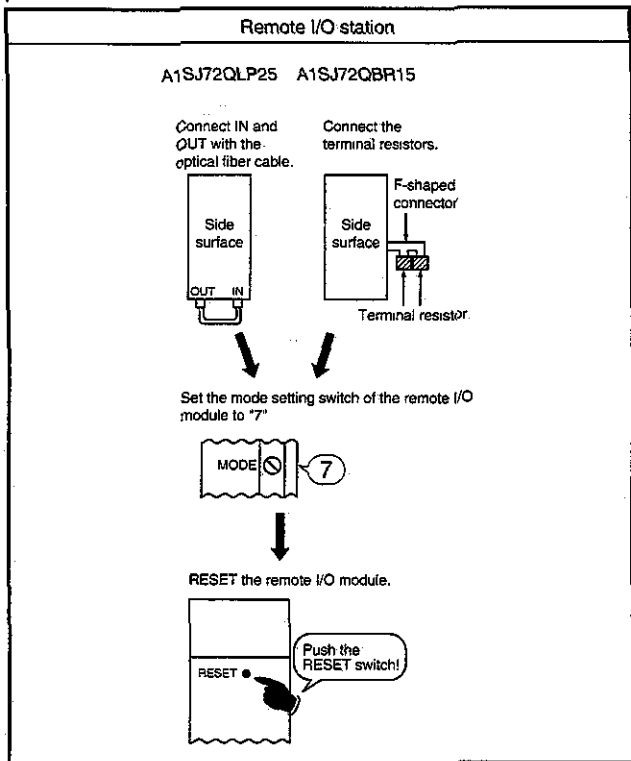

To the next page.

From the previous page.

Self loopback testing in progress!

The test results are indicated on the LED.

<When normal>

The CRC → OVER → AB.IF → TIME → DATA → UNDER LED turn on in order. When this sequence repeats over five times, the system is normal.

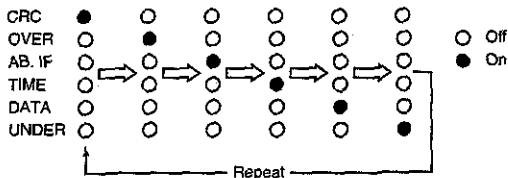

<When there is an error>

For the optical loop systems(A1S.J72QLP25)

- "TIME" LEDs turn on
 - The forward loop cable is disconnected.
 - The transmission side of the forward loop and receiving side is not connected with a cable.
 - The transmission side of the forward loop is connected to the reverse loop's transmission side, and the forward loop's receiving side is connected to the reverse loop's receiving side.
- "DATA" LED turns on
 - The reverse loop cable is disconnected.
 - The reverse loop's transmission side and receiving side is not connected with a cable.
- "CRC", "OVER" and "AB.IF" LED flash.
 - Bad cable
- ERROR LEDs other than those stated in ①, ② and ③ above turns on
 - Hardware error
 - Cable was removed during the test.
 - Cable was disconnected during the test.

For the coaxial bus system (A1S.J72QBR15)

- "TIME" LED turn on
 - The connector was removed.
- "CRC", "OVER" and "AB.IF" LED flash
 - Bad connector
- ERROR LED other than those stated in ① and ② above turn on
 - Hardware error
 - Cable was removed during the test.

5 Handling Precautions

The following is an explanation of handling precautions.

- (1) Because the case of the module is made of resin, be careful not to drop it or expose it to strong impact.
- (2) Switch all phases of the external power supply off before mounting or removing the module. Not doing so could cause failure or malfunction of the module.
- (3) Install so that the pegs on the bottom of the module fit securely into the base module peg holes. Tighten the module terminal screw by the specified torque. Not installing the module correctly could or tightening the screws to the terminal base result in erroneous operation, damage, or pieces of the product falling.
- (4) Execute tightening of the modules fixing screws within the tightening torque range indicated below.

Screw position	Tightening torque range
Module fixing screw (M4 screw)	78.4 to 117.6 N·cm (8 to 12 Kg·cm)

- (5) Be careful that the inside of module is free from debris from wiring, etc. If such debris exists, please remove. It can result in fire, breakdown or malfunction.
- (6) Do not attempt to take the module apart or to alter it in any way. Breakdown, malfunction, damage or fire may result.
- (7) Do not touch the electronic parts or the module conducting area. It may cause erroneous operation or failure.
- (8) When discarding the product, please treat it as an industrial discard.

6 Maintenance and Inspection

For the remote I/O module other than the verification for loose connection of the terminal resistor and the cable, there is very little in regards to inspection topics. In regards to other topics necessary for always using this system in its best possible condition, refer to the inspection topics noted in the PC CPU Users' Manual.

Points
(1) Switch all phases of the external power supply off before cleaning or re-tightening terminal screws. Not doing so could cause failure or malfunction of the module.
(2) Do not disassemble or rebuild the module. It may cause accidents, erroneous operation, injury, or fire.
(3) Switch all phases of the external power supply off before mounting or removing the module. Not doing so could cause failure or malfunction of the module.
(4) Do not touch the electronic parts or the module conducting area. It may cause erroneous operation or failure.

7 External Dimension Diagram

(A1SJ72QLP25)

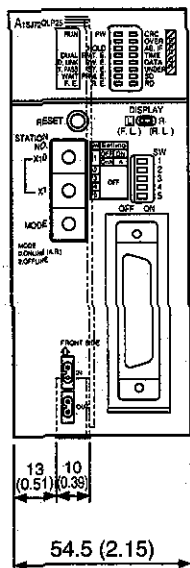
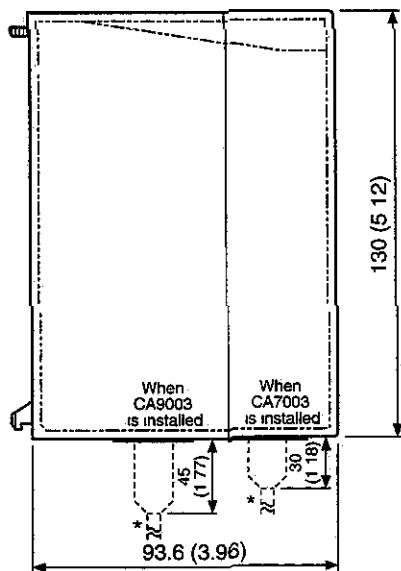

Unit: mm (inch)

* Consider the cable bending radius.
(Refer to Section 4.4.1.)

(A1SJ72QBR15)

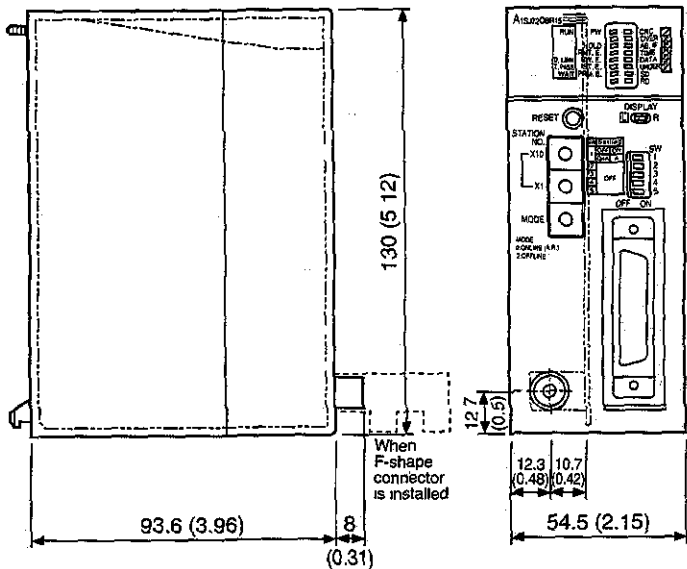

Unit: mm (inch)

* Consider the cable bending radius.
(Refer to Section 4.4.2.)

The United States	Mitsubishi Electronics America, Inc., (Industrial Automation Division) 800 Biermann Court, Mt. Prospect, IL 60056. Phone : (708)298-9223
Canada	Mitsubishi Electric Sales Canada, Inc., (Industrial Automation Division) 4299 14th Avenue, Markham, Ontario L3R 0J2 Phone : (416)475-7728
United Kingdom	Mitsubishi Electric UK Ltd., (Industrial Sales Division) Travellers Lane, Hatfield, Herts., AL10 8XB Phone : (0707)276100
Germany	Mitsubishi Electric Europe GmbH, (Industrial Automation Division) Gothaer Strasse 8, Postfach 1548, D-4030 Ratingen 1 Phone : (02102)4860
Taiwan	Setsuyo Enterprise Co., Ltd., (106) 11th Fl., Chung-Ling Bldg., 363, Sec. 2, Fu-Hsing S. Rd., Taipei, Taiwan, R.O.C. Phone : (02)732-0161
Hongkong (& China)	Ryoden International Ltd., (Industrial & Electrical Controls Division) 10/F., Manulife Tower, 169 Electric Rd., North Point, Hong Kong. Phone : 8878870
Singapore (& Malaysia)	MELCO Sales Singapore Pte. Ltd., (Industrial Division) 307 Alexandra Rd. #05-01/02, Mitsubishi Electric Bldg., Singapore 0315. Phone 4732308
Thailand	F. A. Tech Co Ltd., 1138/33-34 Rama 3 Rd., Yannawa, Bangkok 10120. Phone : (02)295-2861-4
Australia	Mitsubishi Electric Australia Pty. Ltd., (Industrial Controls Division) 348 Victoria Rd., Rydalm ere, N.S.W. 2116. Phone : (02)684-7200
Republic of South Africa	M.S.A Manufacturing (Pty) Ltd., (Factory Automation Division) P.O. Box 39733, Bramley, Johannesburg 2018. Phone : (011)444-8080

 **MITSUBISHI ELECTRIC CORPORATION**
 HEAD OFFICE: MITSUBISHI DENKI BLDG MARUNOUCHI TOKYO 100 TELEX: 284302 CABLE: MELCO TOKYO
 NAGOYA WORKS: 1-14, YASUDA-MINAMI 5, HIGASHIKU, NAGOYA, JAPAN

When exported from Japan, this manual does not require application to the
 Ministry of International Trade and Industry for service transaction permission.