

MITSUBISHI

PROGRAMMABLE CONTROLLER

MELSEC-A

Mitsubishi General Use PC User's Manual

Analog Input/output Module type A1S66ADA (Hardware)

Thank you for buying the Mitsubishi General Use PC MELSEC-A Series. Before use, please read this manual carefully and correctly operate the module with a sufficient understanding of the A series PC functions and performance. Please place this manual in a location where it is available to end users.

MODEL	A1S66ADA-U-H-E
MODEL CODE	13JL42



IB (NA) 66820-C (9808) MEE

● SAFETY PRECAUTIONS ●

(Read these precautions before using.)

When using Mitsubishi equipment, thoroughly read this manual and the associated manuals introduced in the manual. Also pay careful attention to safety and handle the module properly.

These precautions apply only to Mitsubishi equipment. Refer to the CPU module user's manual for a description of the PC system safety precautions.

These ● SAFETY PRECAUTIONS ● classify the safety precautions into two categories: "DANGER" and "CAUTION".



Procedures which may lead to a dangerous condition and cause death or serious injury if not carried out properly.



Procedures which may lead to a dangerous condition and cause superficial to medium injury, or physical damage only, if not carried out properly.

Depending on circumstances, procedures indicated by ⚠ CAUTION may also be linked to serious results.

In any case, it is important to follow the directions for usage.

Store this manual in a safe place so that you can take it out and read it whenever necessary. Always forward it to the end user.

[DESIGN PRECAUTIONS]

⚠ DANGER

- In case of the external power supply failure or the programmable controller (PC) failure, set up a safety circuit outside the PC so that the entire system can operate safely. The mis-output and malfunction may cause an accident.

⚠ CAUTION

- Use the PC in an environment that meets the general specifications contained in this manual. Using this PC in an environment outside the range of the general specifications could result in electric shock, fires, malfunctions, and damage to or deterioration of the product.
- Do not bunch the control wires with the main circuit or power wires, or install them close to each other. They should be installed 100 mm (3.9 inch) or more from each other. Failure to do so may result in noise that would cause malfunctions.

[INSTALLATION PRECAUTIONS]

⚠ CAUTION

- Insert the tabs at the bottom of the module into the mounting holes in the base unit. If the module is not properly installed, it may result in malfunctions, failure, or fallout.
- Do not directly touch the module's conductive parts. Doing so could cause malfunctions or failure in the module.

[WIRING PRECAUTIONS]

⚠ CAUTION

- Ground the AG and FG terminals to the protected grounding conductor when there are a lot of noise. Failure to ground these terminals may cause malfunctions.
- When wiring PC, check the rated voltage and terminal layout of the wiring, and make sure the wiring is done correctly. Connecting a power supply that differs from the rated voltage or wiring it incorrectly may cause fires or failure.
- Tighten the terminal screws within the range of specified torque. If the terminal screws are loose, it may result in short circuits or malfunctions. Tightening the screws too far may cause damage to the screw, resulting in short circuits, or malfunctions.
- Be sure there are no foreign substances such as sawdust or wiring debris inside the module. Such debris could cause fires, failure, malfunctions.

[STARTING AND MAINTENANCE PRECAUTIONS]

⚠ CAUTION

- Do not touch the connector while the power is on. Doing so could cause malfunctions.
- Make sure to switch all phases of the external power supply off before cleaning or re-tightening terminal screws. If you do not switch off the external power supply, it will cause failure or malfunctions of the module.
- Do not disassemble or modify the modules. Doing so could cause failure, malfunctions, injury, or fires.
- Make sure to switch all phases of the external power supply off before mounting or removing the module. If you do not switch off the external power supply, it will cause failure or malfunctions of the module.

[OPERATING PRECAUTIONS]

⚠ DANGER

- Do not output (turn ON) the "usage disable" signal as an output signal to special modules from the PC CPU. Outputting the "usage disable" signal may cause PC system malfunctions.

[DISPOSAL PRECAUTIONS]

⚠ CAUTION

- When disposing of this product, treat it as industrial waste.

About This Manual

The following product manuals are available.

Related Manual

Manual Name	Manual No (Type code)
Analog Input/output Module type A1S66ADA User's Manual	IB-66819 (13JL41)

Please read A1S66ADA Module User's Manual (Details) before using this module.

1. Overview

This manual describes the handling and specifications of the A1S66ADA type Analog I/O Module (hereafter referred to as A1S66ADA), which is utilized in combination with the MELSEC-A series CPU module (hereafter referred to as PC CPU)

- (1) Product in the same package
After unpacking, please confirm that the following product is contained

Product Name	No. of Items
Analog Input/output Module type A1S66ADA	1

2. Performance Specifications

The performance specifications of the A1S66ADA are described below:

Item	Performance Specifications									
	Voltage output				Current output					
Digital input	0 to 4000 (12-bit binary value)									
Analog output I/O characteristics	10 to 10VDC (External load resistance : 2k Ω to 1M Ω)				0 to 20mA DC (External load resistance : 0 Ω to 600 Ω)					
D/A conversion	Digital input	Analog output				Digital input	Analog output			
		0 to 10V range	0 to 5V range	1 to 5V range	10 to 10V range		0 to 20mA range	4 to 20mA range		
		0	0V	0V	1V		-10V	0	0mA	4mA
		1000	2.5V	1.25V	2V		-5V	1000	5mA	8mA
		2000	5V	2.5V	3V		0V	2000	10mA	12mA
A/D conversion	Digital output	Analog input (voltage)				Analog input (current)		Digital output		
		0 to 10V range	0 to 5V range	1 to 5V range	-10 to 10V range	0 to 20mA range	4 to 20mA range			
		0V	0V	1V	10V	0mA	4mA		0	
		2.5V	1.25V	2V	-5V	5mA	8mA		1000	
		5V	2.5V	3V	0V	10mA	12mA		2000	
Overall accuracy	Maximum resolution	2.5mV	1.25mV	1.0mV	5.0mV	5mA	4mA			
		Conversion speed : 240ms/2 channels or less (Sampling : 80ms/1 channel)								
		Absolute maximum output : Voltage : -12V Current : +28mA								
		Output short protection : Present								
		Analog output points : 2 channels								
Offset/gain adjustment : Adjust the two channels simultaneously with the control knob on the front side of the module. The adjustment should be done on-line.										
Analog input : Voltage : 10 to 0 to 10VDC (input resistance: 1M Ω) Current : 0 to 20mA DC (input resistance: 250 Ω)										
Digital output : 0 to 4095 (12-bit binary value)										
A/D conversion	Maximum resolution	Analog input (voltage)				Analog input (current)		Digital output		
		0 to 10V range	0 to 5V range	1 to 5V range	-10 to 10V range	0 to 20mA range	4 to 20mA range			
		0V	0V	1V	10V	0mA	4mA		0	
		2.5V	1.25V	2V	-5V	5mA	8mA		1000	
		5V	2.5V	3V	0V	10mA	12mA		2000	
Overall accuracy	Maximum resolution	2.5mV	1.25mV	1.0mV	5.0mV	5mA	4mA			
		Conversion speed : 400ms/4 channels or less (Sampling : 80ms/1 channel)								
		Absolute maximum input : Voltage : -15V Current : -30mA								
		Analog input points : 4 channels								
		Offset/gain adjustment : Adjust the four channels simultaneously with the control knob on the front side of the module. Check the digital output value on-line while making the adjustments.								
Overall accuracy : Within $\pm 1\%$ (accuracy against the maximum value)										
Insulation method : Photocoupler isolation between I/O terminals and the PC power supply Between each channel: No isolation										
Number of occupying I/O points : 64 points (Input 64 points, output 64 points)										
Connecting terminal base : 20-point terminal base (M3.5 - 7 screws)										
Applicable wire size : 0.75 to 1.25mm ²										
Applicable solderless terminal : R1.25 3 1.25 YS3 2 3 5 2 YS3A V1.25 - M3 V1.25 - YS3A V2 S3 V2 - YS3A										
Internal current consumption (5VDC)(A) : 0.21										
External power supply	Voltage (V) : 21.6DC to 26.4DC									
	Current consumption (A) : 0.16									
Weight (kg)(lb) : 0.33 (0.73)										

Point

When utilizing the peripheral device to assign the I/O numbers, set it as a 64-point output module.



Refer to the User's Manual of the PC CPU for the general specifications

3. Part Identification and Settings

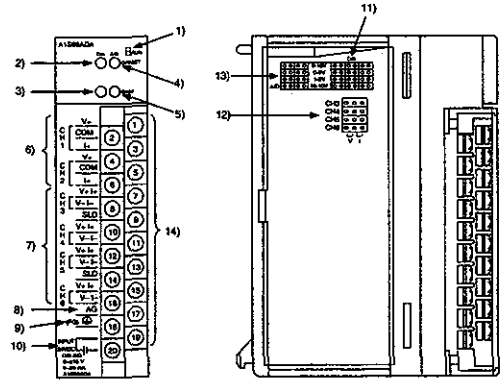
3.1 Part Identification

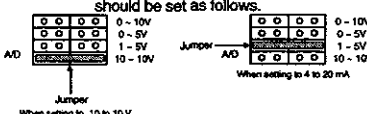

NO.	Name	Description
1)	RUN LED 	Indicates the operating conditions of the A1S66ADA On: Power is ON Off: Power is OFF
2)	D/A conversion offset control knob D/A 	Used when making a fine adjustment of the D/A conversion offset. The offset value is increased by turning the control knob to the right. The offset value is decreased by turning the control knob to the left.
3)	D/A conversion gain control knob D/A 	Used when making a fine adjustment of the D/A conversion gain. The gain value is increased by turning the control knob to the right. The gain value is decreased by turning the control knob to the left.
4)	A/D conversion offset control knob A/D 	Used when making a fine adjustment of the A/D conversion offset. The offset value is increased by turning the control knob to the right. The offset value is decreased by turning the control knob to the left.
5)	A/D conversion gain control knob A/D 	Used when making a fine adjustment of the A/D conversion gain. The gain value is increased by turning the control knob to the right. The gain value is decreased by turning the control knob to the left.
6)	Analog output terminal (CH1, CH2) 	Outputs the analog values (voltage/current) of CH1 to CH2. Refer to Section 5.2 on the wiring method
7)	Analog input terminal (CH3 to CH6) 	Inputs the analog values (voltage/current) of CH3 to CH6. Refer to Section 5.2 on the wiring method
8)	Analog ground terminal	The ground terminal of the analog signal (Refer to Section 5.2 on the wiring method.)
9)	Frame ground terminal	The ground terminal of the shielded cable (Refer to Section 5.2 on the wiring method.)
10)	Power supply input terminal 	Connect 24VDC at the input terminal of the power supply
11)	Analog-output range switching setting pin 	Set the analog output range CH1 CH2 common When setting the current output range, set as follows: When switching to 0 to 20 mA f. Set a jumper at a position between 0 V and 5 V When switching to 4 to 20 mA f. Set a jumper at a position between 1 V and 5 V Set the jumper as it always makes a line (Set it with the jumper) (Setting at shipment : 0 to 10V range) (Example) When the analog output range is set to 0 to 10 V or 0 to 20 mA, the jumper should be set as follows

NO.	Name	Description
12)	Analog-input voltage/current switching setting pin 	Set the analog input (voltage input or current input) for each channel (CH3 to CH6) for each channel (CH3 to CH6) (Set it with the jumper) (Setting at shipment : V) For voltage input setting : V For current input setting : I
13)	Analog input range switching setting pin 	Set the analog output range CH3 to CH6 common When setting the current output range, set as follows: When switching to 0 to 20 mA fi. Set a jumper at a position between 0 V and 5 V When switching to 4 to 20 mA fi. Set a jumper at a position between 1 V and 5 V (Setting at shipment : 0 to 10V range) (Set it with the jumper) (Example) When the analog input range is set to -10 to 10 V or 4 to 20 mA, the jumper should be set as follows.  Jumper When setting to 10 to 10 V
14)	Terminal block	Numbers in a graphic indicate terminal numbers.

4.3 Installation Environment

Never install the A series in the following environments:

- (1) Locations where the ambient temperature is outside the range of 0 to 55 C
- (2) Locations where the ambient humidity is outside the range of 10 to 90% RH
- (3) Locations where dew condensation takes place due to sudden temperature changes
- (4) Locations where there are corrosive and/or combustible gasses
- (5) Locations where there is a high level of conductive powder (such as dust and iron filings, oil mist, salt, and organic solvents)
- (6) Locations exposed to the direct rays of the sun
- (7) Locations where strong power and magnetic fields are generated
- (8) Locations where vibration and shock are directly transmitted to the main module

4. Loading and Installation

4.1 Handling Precautions

- (1) Do not drop or put a great impact on the module case and the terminal block because they are made of resin
- (2) Do not take the printed circuit board of the module out of the case it may result in a failure
- (3) Be careful not to let foreign matter such as filings or wire chips get inside the module while wiring. Remove all foreign matters if any get inside
- (4) Tighten the module installation screws and terminal screws within the range as follows:

Screw Area	Tightening Torque Range N-cm (kg-cm) [lb-inch]
Module fixing screws (M4 screw)	78 to 118N-cm (8 to 12kgf-cm) [6.93 to 10.4]
Terminal block terminal screws (M3.5 screw)	59 to 88N-cm (6 to 9kgf-cm) [5.2 to 7.8]
Terminal block installation screws (M4 screw)	78 to 118N-cm (8 to 12kgf-cm) [6.93 to 10.4]

4.2 Installation and Removal of the Shield Cover

It is necessary to install the shield cover when using Procedures for installing and removing the shield cover are described below

(1) Installation

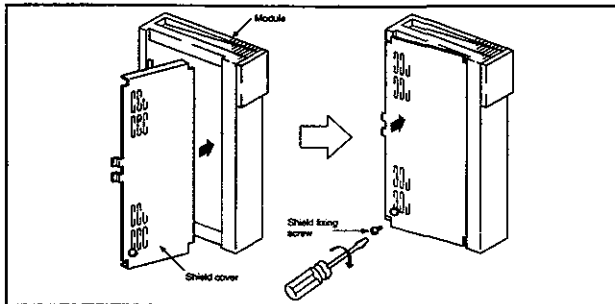

To install the shield cover to the module, install the cover to the terminal side first as shown in the figure, then it will be completed by pushing the cover to the module and tightening the shield fixing screw

(2) Removal

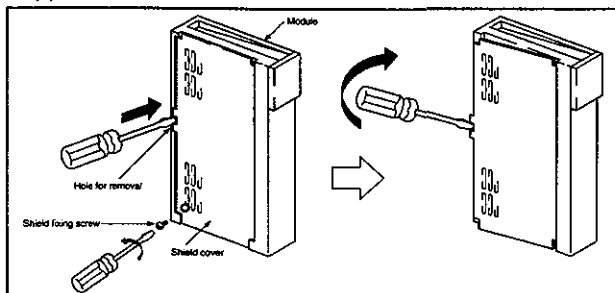

To remove the cover from the module, remove the shield fixing screw first and insert the tip of a flat-tip screwdriver into the removal hole as shown in the figure, then move the screwdriver towards the rear of the module to separate the clip from the removal hole and remove the cover

5. Wiring

The following describes the precautionary items on wiring as well as wiring to the external devices

5.1 Precautions when Wiring

To obtain the maximum performance from the functions of A1S66ADA and improve the system reliability, a wiring with the high durability against the noise is required. The external wiring precautions described below make more improvement in the wiring not to be affected by the noise

- (1) Use separate cables for the AC and the analog input to the A1S66ADA, in order not to be affected by the AC side surge or conductivity
- (2) Do not bundle or place the cable close to the main circuit line, high voltage line or load carrying wires from other than the PC. It is influenced more easily by the noise, surge, or conductivity
- (3) Place a one-point grounding on the PC side for the shield line or shield cable. However, depending on the external noise conditions, it may be better to have a grounding externally

5.2 Wiring Between the A1S66ADA and the External Devices

The following shows the wiring method for the A1S66ADA

(1) CH1 and CH2

(a) For voltage output

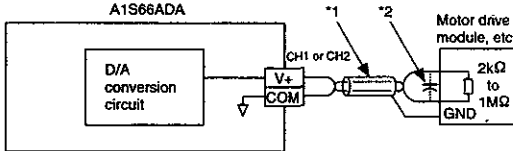

(b) For current output

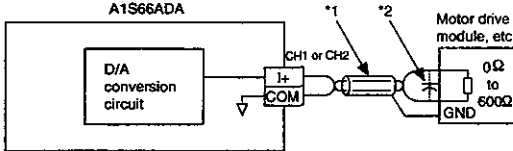

*1 Use a two-core twisted shield line for the power cable

*2 When noise or ripple occurs with the external cable, connect a condenser with 0.1 to 0.47mFVWV to the input terminal of the external device.

Important

The voltage and current output can not be used simultaneously on the same channel
In the event it is used, the internal elements are destroyed;
therefore always open unused terminals.

6. External Dimensions Diagram

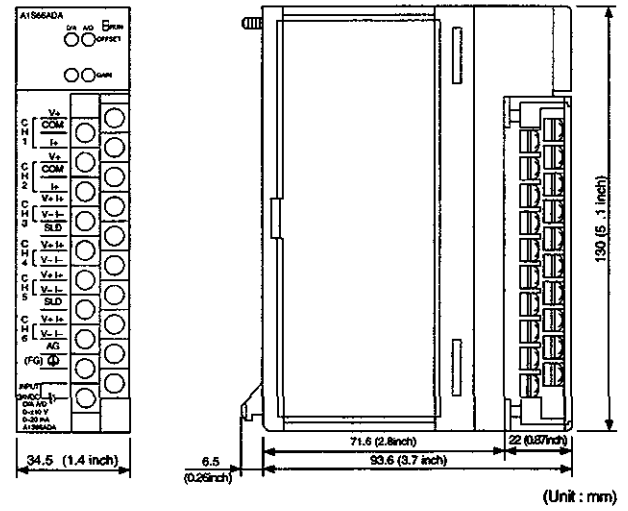

(Unit : mm)

(2) CH3 to CH6

(a) For voltage input

Signal source 0 to -10V

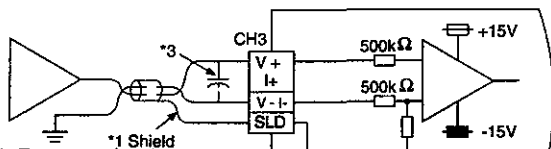

(b) For current input

Signal source 0 to -20mA

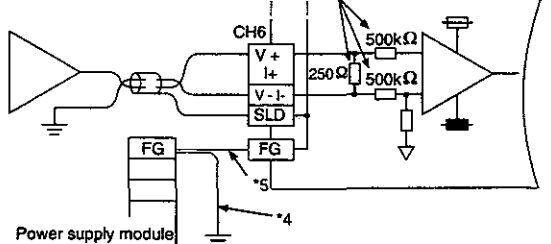

*1 Use a two-core twisted shield line for the power cable

*2 Indicates the A1S66ADA input resistance

*3 When noise or ripple occurs with the external cable, connect a condenser with about 0.1 to 0.47mF25WV between the terminal V+ and V-

*4 The FG terminal of the power supply module should always be grounded

*5 Make sure to connect between the FG of the power supply module and the FG of A1S66ADA

Point

The FG terminal of A1S66ADA and the FG terminal of the PC power supply module are not connected.

The United States	Mitsubishi Electronics America, Inc. (Industrial Automation Division) 800 Biemann Court, Mt. Prospect, IL 60056 Phone : (708) 298-9223
Canada	Mitsubishi Electric Sales Canada, Inc., (Industrial Automation Division) 4299 14th Avenue, Markham, Ontario L3R 0J2 Phone : (416) 475-7728
United Kingdom	Mitsubishi Electric UK Ltd., (Industrial Sales Division) Travellers Lane, Hatfield, Herts, AL10 8XB Phone : (0707) 276100
Germany	Mitsubishi Electric Europe GmbH, (Industrial Automation Division) Gothaer Strasse 8, Postfach 1548, D-4030 Ratingen 1 Phone : (02102) 4860
Taiwan	Setsuyo Enterprise Co., Ltd., (106) 11th Fl., Chung-Ling Bldg. 363 Sec 2, Fu-Hsing S Rd., Taipei, Taiwan R.O.C Phone : (02) 732-0161
Hongkong (& China)	Ryoden International Ltd., (Industrial & Electrical Controls Division) 10/F Manulife Tower, 169 Electric Rd., North Point, Hong Kong. Phone : 8878870
Singapore (& Malaysia)	MELCO Sales Singapore Pte. Ltd., (Industrial Division) 307 Alexandra Rd. #05-01/02, Mitsubishi Electric Bldg., Singapore 0315 Phone : 4732308
Thailand	F.A. Tech Co., Ltd., 1138/33-34 Rama 3 Rd., Yannawa, Bangkok 10120 Phone : (02) 295-2861-4
Australia	Mitsubishi Electric Australia Pty Ltd., (Industrial Controls Division) 348 Victoria Rd., Rydalmere NSW 2116 Phone : (02) 684-7200
Republic of South Africa	M.S.A. Manufacturing (Pty) Ltd., (Factory Automation Division) P O Box 39733 Bramley Johannesburg 2018 Phone : (011) 444-8080

MITSUBISHI ELECTRIC CORPORATION
HEAD OFFICE: 2-1-1 HONCHO, KAMATA-KU, TOKYO 158, JAPAN
MAGYARORSZAG: 114 TUDOMANYSI HOSZAGHALLJAKI UDVAR, BUDAPEST, HUNGARY

When exported from Japan, this manual does not require application to the Ministry of International Trade and Industry for service transaction permission

Specifications subject to change without notice
Printed in Japan on recycled paper