

CL1Y4-T1B2
 CC-Link/LT Remote I/O Module

Please read this manual thoroughly before starting to use the product and handle the product properly.

User's Manual

MODEL	CL1Y4-T1B2
MANUAL Number	JY997D04201B
Date	NOVEMBER 2002

●SAFETY PRECAUTIONS●

(Read these precautions before using)

Please read this manual carefully and pay special attention to safety in order to handle this product properly. Also pay careful attention to safety and handle the module properly.

These precautions apply only to Mitsubishi equipment. Refer to the user's manual of the CPU module to use for a description of the PLC system safety precautions.

These ●SAFETY PRECAUTIONS● classify the safety precautions into two categories: "DANGER" and "CAUTION".



Procedures which may lead to a dangerous condition and cause death or serious injury if not carried out properly.

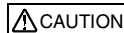

Procedures which may lead to a dangerous condition and cause superficial to medium injury, or physical damage only, if not carried out properly.

Depending on circumstances, procedures indicated by CAUTION may also be linked to serious results.

In any case, it is important to follow the directions for usage. Store this manual in a safe place so that you can take it out and read it whenever necessary. Always forward it to the end user.

[DESIGN PRECAUTIONS]



- Configure an interlock circuit in a sequence program so that the system operates on the safety side using the communication status information in the event the data link falls into a communication problem. Otherwise, erroneous output and malfunction may result in accidents.
- Remote input and output can not be switched ON or OFF when a problem occurs in the remote I/O modules. Therefore build an external monitoring circuit that will monitor any input signals that could cause a serious accident.

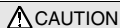

- Do not have control cables and communication cables bundled with or placed near by the main circuit and/or power cables. Wire those cables at least 100mm(3.94 inch) away from the main circuit and/or power cables. It may cause malfunction due to noise interference.
- Use the module and the flat cable dedicated to CC-Link/LT without applying any force on them. Otherwise, such cables may be broken or fail.

[INSTALLATION PRECAUTIONS]



- Use the module in an environment that meets the general specifications contained in this manual. Using this module in an environment outside the range of the general specifications could result in electric shock, fire, erroneous operation, and damage to or deterioration of the product.
- Do not directly touch the module's conductive parts. Doing so could cause malfunction or trouble in the module.
- Tighten the module securely using DIN rail or installation screws within the specified torque range. If the screws are too loose, the module may drop from its installation position, short circuit, or malfunction. If the screws are too tight, the screws may be damaged, which may cause the module to drop from its installation position or short circuit.
- Install the module on a flat surface. If the mounting surface has concave and/or convex, an excessive force may be applied on the module, and nonconformity may be caused.

[WIRING PRECAUTIONS]

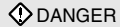

- Perform installation and wiring after disconnecting the power supply at all phases externally. If the power is not disconnected at all phases an electric shock or product damage may result.

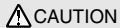

- Terminal screws which are not to be used must be tightened always. Otherwise there will be a danger of short circuit against the bare solderless terminals.
- Perform correct wiring for the module according to the product's rated voltage and terminal arrangement. Connecting to a power supply different from rating or miss-wiring may cause fire, product failure or malfunction.
- Fix terminal screws securely within the regulated torque. Loose terminal screws may cause fire and/or malfunction. If the terminal screws are too tight, it may cause short circuit or erroneous operation due to damage of the screws.
- Make sure foreign objects do not get inside the module, such as dirt and wire chips. It may cause fire, product failure or malfunction.
- Attach a warning label (hazard symbol 417-IEC-5036) concerning the electric shock to the location.

[STARTING AND MAINTENANCE PRECAUTIONS]

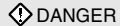

- Do not touch the terminals when the power is ON. It may cause an electric shock or malfunction.
- Perform cleaning the module or retightening of terminal screws after turning OFF the all external power supply for sure. Failure to do so may cause failure or malfunction of the modules



- Do not disassemble or modify the module. Doing so may cause failure, malfunction, injury, or fire.
- The module case is made of resin; do not drop it or subject it to strong shock. A module damage may result.
- Make sure to switch all phases of the external power supply OFF before installing or removing the module to/from the panel. Failure to do so may cause failure or malfunction of the modules.

[DISPOSAL PRECAUTIONS]

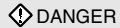

- When disposing of this product, treat it as industrial waste.

[TRANSPORTATION AND MAINTENANCE PRECAUTIONS]



- During transportation avoid any impact as the module is a precision instrument. Doing so could cause trouble in the module.
- If it is necessary to check the operation of module after transportation, in case of any impact damage.

●Notification of CE marking●

This notification does not guarantee that an entire mechanical module produced in accordance with the contents of the notification comply with the following standards. Compliance to EMC standards of the entire mechanical module should be checked by the user / manufacturer.

Standards with which this product complies

Type : Programmable Controller (Open Type Equipment) Remote I/O module
 Models : Products manufactured from November 1st, 2002.

Electromagnetic Compatibility Standards (EMC)	Remark
EN61000-6-4:2001 Electromagnetic compatibility -Generic standards - Emission standard for Industrial environment	Compliance with all relevant aspects of the standard. (Radiated Emissions and Mains Terminal Voltage Emissions)
EN61131-2:1994 Programmable controllers /A11: 1996 -Equipment requirements and tests /A12: 2000	Compliance with all relevant aspects of the standard. (RF Immunity, Fast transients, ESD and Damped oscillatory wave)

For more details please contact the local Mitsubishi Electric sales site.
 - Notes For compliance to EMC regulation.
 It is necessary to install the CL1 series module in a shielded metal control panel.

1. Outline of Product

This product is a terminal block type output module connected to CC-Link/LT.

This product has four output points (transistor output).

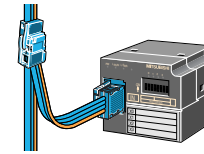

2. Name and Setting of Each Part and Terminal Arrangement

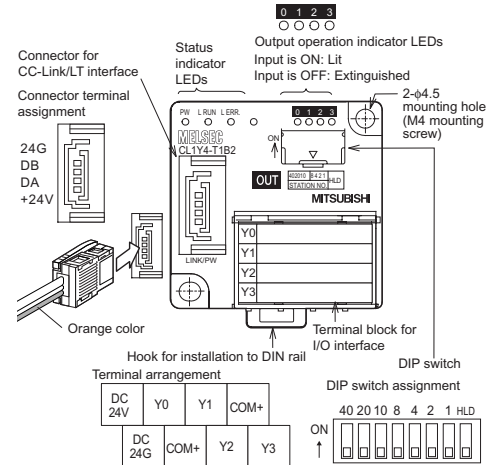

3. Cautions on Handling

The CL1Y4-T1B2 can be installed to DIN rail or directly installed using mounting screws.

Each installation procedure is described below.

3.1 Installation to DIN rail

Align the upper DIN rail installation groove in the module with the DIN rail 1), and press the module in that status 2).

When removing the module, pull the hook downward for installation to DIN rail 3), then remove the module 4).

DIN rail mounting screw pitch

When installing the module to the DIN rail, tighten the mounting screws at the pitch of 200mm(7.87") or less.

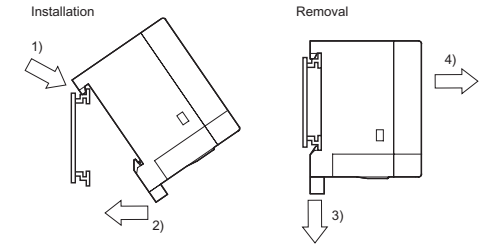

Applicable DIN rail TH35-7.5Fe and TH35-7.5Al (conforming to JIS C2812)

3.2 Direct installation

Screw-tighten the module by attaching M4 screws to the upper and lower mounting holes (two holes in all) provided in the module. Install the module so that the clearance of 1 to 2mm (0.04" to 0.08") is assured for each module.

Applicable screw M4 × 0.7mm(0.03") × 16mm(0.63") or more (Tightening torque range: 78 to 108 N-cm)

Name	Description																
PW	ON while the power is supplied.																
L RUN	ON while normal operation is executed.																
Status indicator LED	L ERR: ON: When a communication error or DIP switch setting error occurred Flickering at a constant interval: When the setting of the DIP switch was changed while the power was supplied (even while the LED is flickering, the operation continues. The new setting becomes valid when the power is turned OFF once, then ON again.) Flickering at an intermittent interval: When a terminal resistor is not attached or when the module or a connection cable is affected by noise																
	L RUN	ON while the power is supplied.															
Output operation indicator LEDs	ON while the output is ON. Extinguished while the output is OFF. Output operation indicator																
Interface	Connector for CC-Link/LT communication line/module power supply (24G/DB/DA/+24V)																
Terminal block for I/O interface	Terminal block to connect output signals and load power supply																
DIP switch	Set the 10's digit of the station No. using "STATION NO. 10", "STATION NO. 20" and "STATION NO. 40". Set the 1's digit of the station No. using "STATION NO. 1", "STATION NO. 2", "STATION NO. 4" and "STATION NO. 8". Factory default = All bits are OFF. Make sure to set the station No. in the range from 1 to 64. If any station No. outside the range from 1 to 64 is set, it is regarded as an error and the L ERR. LED lights. Example: When setting the station No. to "32", set the DIP switch as follows. <table border="1" style="margin-left: 20px;"> <tr> <td>Station No.</td> <td>40</td> <td>20</td> <td>10</td> <td>8</td> <td>4</td> <td>2</td> <td>1</td> </tr> <tr> <td>32</td> <td>OFF</td> <td>ON</td> <td>ON</td> <td>OFF</td> <td>OFF</td> <td>ON</td> <td>OFF</td> </tr> </table>	Station No.	40	20	10	8	4	2	1	32	OFF	ON	ON	OFF	OFF	ON	OFF
Station No.	40	20	10	8	4	2	1										
32	OFF	ON	ON	OFF	OFF	ON	OFF										
HLD	Holds the output (when an error has occurred). ON: Holds the output. OFF: Clears the output.																

4. Connection to External Equipment and Power Supply

4.1 External wiring

The output terminals of the CL1Y4-T1B2 are fixed to the sink output.

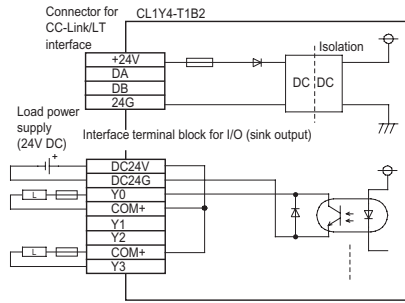

4.2 Crimp-style terminal

For I/O wiring, use crimp-style terminals of the following dimensions.

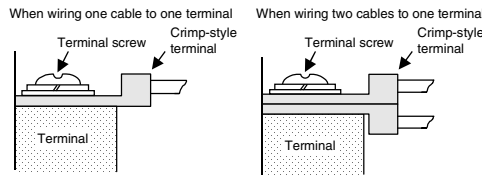
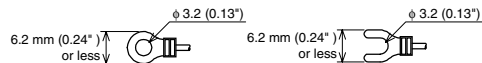

Applicable crimp-style terminal	<ul style="list-style-type: none"> RAV1.25-3 (conforming to JIS C2805) V1.25-3 (manufactured by JST Mfg. Co., Ltd.) 1.25-3 and TG1.25-3 (manufactured by NICHIFU Co., Ltd.)
Applicable wire size	0.3 to 1.25 mm ²

Use a crimp-style terminal in a status in which no force is applied on the cable.

4.3 Module terminal screw

Tighten the terminal screws (M3 screws) on the terminal block with a tightening torque of 42 to 58 N·cm.

5. Specifications

5.1 General specifications

Item	Specification		
Ambient working temperature	0 to 55°C (32 to 131°F) (*1)		
Ambient storage temperature	-25 to 75°C (-13 to 167°F) (*1)		
Ambient operating humidity	Conforming to JIS B3502 and IEC61131-2, Level RH-2 (5 to 95%RH: Dew condensation shall not be considered.)		
Ambient storage humidity	Conforming to JIS B3502 and IEC61131-2, Level RH-2 (5 to 95%RH: Dew condensation shall not be considered.)		
Vibration resistance	Conforming to JIS B3502 and IEC61131-2	When intermittent vibration is present	Number of times of sweep 10 times in each of X, Y and Z directions (for 80 min)
		Frequency Acceleration Half amplitude	
	Conforming to JIS B3502 and IEC61131-2	When continuous vibration is present	
		Frequency Acceleration Half amplitude	
Impact resistance	Conforming to JIS B3502 and IEC61131-2 (147 m/s ² , 3 times in each of X, Y and Z directions)		
Operating atmosphere	Corrosive gas shall not be present.		
Operating altitude	Conforming to JIS B3502 and IEC61131-2 (2,000m(6561'8") or less)(*2)		
Installation place	Inside control panel (*3)		
Over-voltage category	Conforming to JIS B3502 and IEC61131-2 (Category II or less)(*4)		
Degree of contamination	Conforming to JIS B3502 and IEC61131-2, Degree of contamination 2 or less (*5)		

Notes:

- *1 The ambient operating/storage temperature satisfies the requirements based on the specification in the JIS B3502 and the IEC61131-2.
- *2 The module cannot be used in an environment pressurized above the atmospheric pressure which can be generated around the altitude of 0 m. If the module is used in such an environment, it may fail.
- *3 The module can be used in any environment even outside the control panel as far as the requirements of the ambient operating temperature, the ambient operating humidity, etc. are satisfied.
- *4 This indicates the section of the power supply to which the equipment is assumed to be connected between the public electrical power distribution network and the machinery within premises. Category II applies to equipment for which electrical power is supplied from fixed facilities. The surge voltage withstand level for up to the rated voltage of 300V is 2500V.
- *5 This index indicates the degree of conductive generating substances in the environment in which the module is used. The degree of contamination 2 indicates that contamination is caused by generation of only non-conductive substances. In this degree, however, temporary conduction may be caused by accidental condensation.

5.2 Output specifications

Item	Specification
Output method	Transistor output (Load power supply) (sink)
Number of outputs	4 points
Isolation method	Isolation with photocoupler
Rated load voltage	12/24V DC
Operating load voltage range	10.2 to 28.8 VDC (Ripple ratio: Within 5%)
Max. load current	0.1A/point, 0.4 A/1 common
Max. inrush current	0.4A/10 ms
Leakage current at OFF	0.1mA or less/30V DC
Max. voltage drop at ON	0.3V or less (typical)/0.1 A 0.6V or less (max.)/0.1A
Response time	OFF→ON
	ON→OFF
Surge suppression	Zener diode
Common wiring method	4 points/1 common (2 points) (terminal block two-wire type)
Internal protection for outputs	Internal protection circuit none Please connect the fuse in the connected load outside.

5.3 Performance specifications

Item	Specification	
Module power supply	Voltage	20.4 to 28.8V DC (24V DC -15% to +20%) Ripple ratio: Within 5%
	Current consumption	60mA (when all points are ON)
	Initial current	70mA
	Max. allowable momentary power failure period	PS1:1ms
Number of stations occupied	4-, 8- or 16-point mode: 1 station	
Noise durability	500Vp-p Noise width: 1μs Cycle: 25 to 60 Hz (by noise simulator)	
Withstand voltage	500V AC for 1 min	
Isolation resistance	10 MΩ or more between primary area (external DC terminal) and secondary area (internal circuit) by 500V DC megger	
Protection class	IP2X	
I/O part connection method	Connection with terminal block	
Module installation method	DIN rail installation, mounted by screws of type M4 × 0.7mm(0.03") × 16mm(0.63") or larger Can be installed in six directions	
Mass (weight)	0.06kg (0.13lbs)	

6. Outside Dimensions

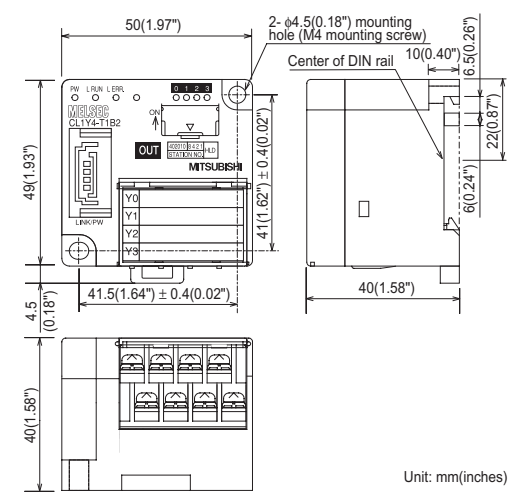

Unit: mm(inches)

Warranty

Mitsubishi will not be held liable for damage caused by factors found not to be the cause of Mitsubishi; machine damage or lost profits caused by faults in the Mitsubishi products; damage, secondary damage, accident compensation caused by special factors unpredictable by Mitsubishi; damages to products other than Mitsubishi products; and to other duties.

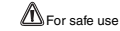

- For safe use
- This product has been manufactured as a general-purpose part for general industries, and has not been designed or manufactured to be incorporated in a device or system used in purposes related to human life.
 - Before using the product for special purposes such as nuclear power, electric power, aerospace, medicine or passenger movement vehicles, consult with Mitsubishi.
 - This product has been manufactured under strict quality control. However when installing the product where major accidents or losses could occur if the product fails, install appropriate backup or failsafe functions in the system.

Country/Region	Sales office/Tel	Country/Region	Sales office/Tel
U.S.A	Mitsubishi Electric Automation Inc. 500 Corporate Woods Parkway Vernon Hills, IL 60061 Tel : +1-847-478-2100	China	Ryoden International Shanghai Ltd. 3F Blocks Building Automation Instrumentation Plaza 103 Cao Bao Rd. Shanghai 200233 China Tel : +86-21-6475-3228
Brazil	MELCO-TEC Rep. Com.e Assessoria Tecnica Ltda. Av. Rio Branco, 123-15, and S/1507, Rio de Janeiro, RJ CEP 20040-005, Brazil Tel : +55-21-221-8343	Taiwan	Setsumo Enterprise Co., Ltd. 6F, No.105 Wu-Kung 3rd RD, Wu-Ku Hsiang, Taipei Hsing, Taiwan Tel : +886-2-2299-2499
Germany	Mitsubishi Electric Europe B.V. German Branch Golhofer Strasse 8 D-40880 Ratingen, GERMANY Tel : +49-2102-486-0	Korea	HAN NEUNG TECHNO CO.,LTD. 1F Dong Seo Game Channel Bldg, 660-11, Deungchon-dong Kangseck-ku, Seoul, Korea Tel : +82-2-3660-9552
U.K	Mitsubishi Electric Europe B.V. UK Branch Travellers Lane, Hatfield, Herts., AL10 9BX, UK Tel : +44-1707-276100	Singapore	F. A. Tech Co. Ltd. 898/28,29,30 S.V.City Building,Office Tower 2, Floor 17-18 Rama 3 Road, Bangkokpingsang, Yamawa, Bangkok 10120 Tel : +66-2-682-6522
Italy	Mitsubishi Electric Europe B.V. Italian Branch Centro Dir. Coleoni, Pal. Persico - Ingr:2 Via Paracelso 12, 20041 Agrate B., Milano, Italy Tel:+39-039-60531	Thailand	F. A. Tech Co. Ltd. 898/28,29,30 S.V.City Building,Office Tower 2, Floor 17-18 Rama 3 Road, Bangkokpingsang, Yamawa, Bangkok 10120 Tel : +66-2-682-6522
Spain	Mitsubishi Electric Europe B.V. Spanish Branch Carretera de Rubi 76-80 08190 - Sant Cugat del Valles, Barcelona, Spain Tel:+34-935-653135	Indonesia	PT. Autotekrindo SUMBER MAKMUR Jl. Muara Karang Selatan BlockA Utara No.1 Kav. No.11 KawasanIndustri/ Pergudangan,Jakarta - Utara 14440 Tel : +62-21-663-0833
South Africa	Circuit Breaker Industries LTD. Private Bag 2016, Isando 1600, Johannesburg, South Africa Tel : +27-11-928-2000	India	Messung Systems Pvt.Ltd. Electronic Sadan NO:111 Unit No15, M.I.D.C BHOSARI PUNE-411026 Tel : +91-20-7128927
Hong Kong	Ryoden Automation Ltd. 10th Floor, Manulife Tower, 169 Electric Road, North Point, HongKong Tel : +852-2887-8870	Australia	Mitsubishi Electric Australia Pty. Ltd. 348 Victoria Road, PostalBag, No.2, Rydalmere, N.S.W 2116, Australia Tel : +61-2-9684-7777

MITSUBISHI ELECTRIC CORPORATION
 HEAD OFFICE : MITSUBISHI DENKI BLDG MARUNOUCHI TOKYO 100-8310 TELEX:24532 CABLE MELCO TOKYO
 HIMEJI WORKS : 840, CHUYODA CHO, HIMEJI, JAPAN

When exported from Japan, this manual does not require application to the Ministry of Economy, Trade and Industry for service transaction permission.

Specifications are subject to change without notice

