

Please read this manual thoroughly before starting to use the product and handle the product properly.

User's Manual

MODEL	CL1X2-D1D3S
MANUAL Number	JY997D03901D
Date	DECEMBER 2003

●SAFETY PRECAUTIONS●

(Read these precautions before using)

Please read this manual carefully and pay special attention to safety in order to handle this product properly. Also pay careful attention to safety and handle the module properly.

These precautions apply only to Mitsubishi equipment. Refer to the user's manual of the CPU module to use for a description of the PLC system safety precautions.

These ●SAFETY PRECAUTIONS● classify the safety precautions into two categories: "DANGER" and "CAUTION".



Procedures which may lead to a dangerous condition and cause death or serious injury if not carried out properly.

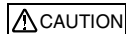

Procedures which may lead to a dangerous condition and cause superficial to medium injury, or physical damage only, if not carried out properly.

Depending on circumstances, procedures indicated by **CAUTION** may also be linked to serious results.

In any case, it is important to follow the directions for usage.

Store this manual in a safe place so that you can take it out and read it whenever necessary. Always forward it to the end user.

DESIGN PRECAUTIONS



- Configure an interlock circuit in a sequence program so that the system operates on the safety side using the communication status information in the event the data link falls into a communication problem. Otherwise, erroneous output and malfunction may result in accidents.
- Remote input and output can not be switched ON or OFF when a problem occurs in the remote I/O modules. Therefore build an external monitoring circuit that will monitor any input signals that could cause a serious accident.

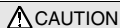

- Do not have control cables and connection cables bundled with or placed near by the main circuit and/or power cables. Wire those cables at least 100mm(3.94 inch) away from the main circuit and/or power cables. It may cause malfunction due to noise interference.
- Use the module in the status in which any force is not applied on the module, flat cables dedicated to CC-Link/LT and flat cables for I/O. If a force is applied, wire breakage or failure may be caused.

INSTALLATION PRECAUTIONS



- Use the module in an environment that meets the general specifications contained in this manual. Using this module in an environment outside the range of the general specifications could result in electric shock, fire, erroneous operation, and damage to or deterioration of the product.
- Do not directly touch the module's conductive parts. Doing so could cause malfunction or trouble in the module.

WIRING PRECAUTIONS



- Perform installation and wiring after disconnecting the power supply at all phases externally. If the power is not disconnected at all phases an electric shock or product damage may result.

CAUTION

- Perform correct wiring for the module according to the product's rated voltage and terminal arrangement. Connecting to a power supply different from rating or miss-wiring may cause fire, product failure or malfunction.
- Make sure foreign objects do not get inside the module, such as dirt and wire chips. It may cause fire, product failure or malfunction.
- Do not short-circuit the 24G and +24V terminals. It may result in fire, product failure or malfunction.
- Attach a warning label (hazard symbol 417-IEC-5036) concerning the electric shock to the location.

STARTING AND MAINTENANCE PRECAUTIONS

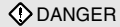

- Do not touch the terminals when the power is ON. It may cause an electric shock or malfunction.
- Perform cleaning the module after turning OFF the all external power supply for sure. Failure to do so may cause failure or malfunction of the modules.



- Do not disassemble or modify the module. Doing so may cause failure, malfunction, injury, or fire.
- The module case is made of resin; do not drop it or subject it to strong shock. A module damage may result.
- Make sure to switch all phases of the external power supply OFF before installing or removing the module to/from the panel. Failure to do so may cause failure or malfunction of the modules.

DISPOSAL PRECAUTIONS

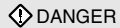

- When disposing of this product, treat it as industrial waste.

TRANSPORTATION AND MAINTENANCE PRECAUTIONS

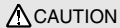

- During transportation avoid any impact as the module is a precision instrument. Doing so could cause trouble in the module.
- If it is necessary to check the operation of module after transportation, in case of any impact damage.

ND MAINTENANCE PRECAUTIONS



- During transportation avoid any impact as the module is a precision instrument. Doing so could cause trouble in the module.
- If it is necessary to check the operation of module after transportation, in case of any impact damage.

●Notification of CE marking●

This notification does not guarantee that an entire mechanical module produced in accordance with the contents of the notification comply with the following standards. Compliance to EMC standards of the entire mechanical module should be checked by the user / manufacturer.

Standards with which this product complies

Type : Programmable Controller (Open Type Equipment) Remote I/O module
 Models : Products manufactured from November 1st, 2002.

Electromagnetic Compatibility Standards (EMC)	Remark
EN61000-6-4:2001 Electromagnetic compatibility -Generic standards - Emission standard for Industrial environment	Compliance with all relevant aspects of the standard. (Radiated Emissions and Mains Terminal Voltage Emissions)
EN61131-2:1994 Programmable controllers /A11: 1996 -Equipment requirements and tests /A12: 2000	Compliance with all relevant aspects of the standard. (RF Immunity, Fast transients, ESD and Damped oscillatory wave)

For more details please contact the local Mitsubishi Electric sales site.
 - Notes For compliance to EMC regulation.
 It is necessary to install the CL1 series module in a shielded metal control panel.

1. Outline of Product

This product is a cable type input module connected to CC-Link/LT.
 This product has two input points (24V DC).

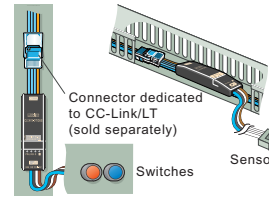

2. Name and Setting of Each Part

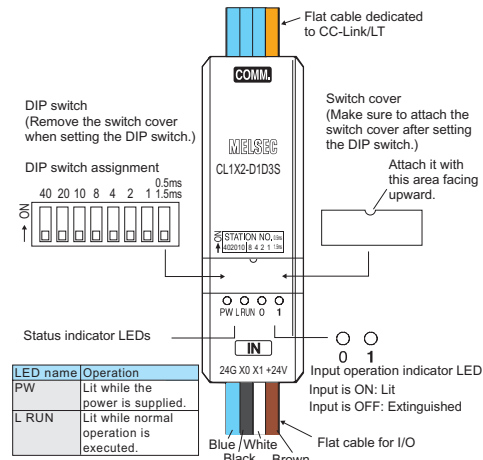

Name	Description
Status indicator LED	PW ON while the power is supplied.
	L RUN ON while normal operation is executed.
Input operation indicator LED	0 ON while the input is ON. 1 Extinguished while the input is OFF.
	X0 input operation indicator LED X1 output operation indicator LED
Flat cable dedicated to CC-Link/LT	24G DB Connector for CC-Link/LT communication line/module power supply
	+24V DA
	Blue 24G Flat cable for I/O
Flat cable for I/O	Black X0
	White X1
	Brown +24V
DIP switch	Set the 10's digit of the station No. using "STATION NO. 10", "STATION NO. 20" and "STATION NO. 40". Set the 1's digit of the station No. using "STATION NO. 1", "STATION NO. 2", "STATION NO. 4" and "STATION NO. 8". Factory default = All bits are OFF. Make sure to set the station No. in the range from 1 to 64.
	Example: When setting the station No. to "32", set the DIP switch as follows.

Station No.	10's digit				1's digit			
	40	20	10	8	4	2	1	
32	OFF	ON	ON	OFF	OFF	ON	OFF	

Name	Description
DIP switch	0.5ms Sets the response speed.
	1.5ms ON: 0.5 ms (fast response type) OFF: 1.5 ms (standard type)

3. Cautions on Handling

3.1 Handling of flat cable for I/O

The cable length from the module to a sensor shall be within 3m(9'10"). Measure the cable outside the module, and confirm that the driving voltage for the used sensor is assured.

- Input

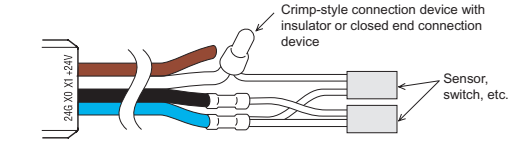

If the diameter of the input equipment connection cable is equivalent to the diameter of the flat cable for I/O of this module, connectors dedicated to CC-Link/LT can be used for connection.

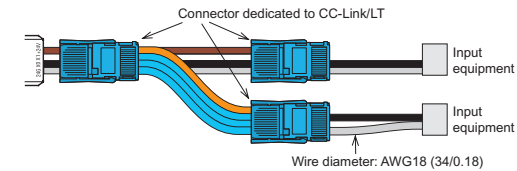

3.2 Handling of cable

Do not bend the cable within 30mm(1.18") from the module.

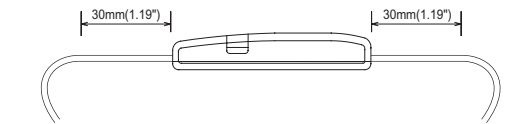

Use a crimp-style terminal in a status in which no force is applied on the cable.

3.3 Mounting with the CL1-HLD (module holder)

Refer to the figures below for details on mounting or removing the remote I/O module when used with the CL1-HLD.

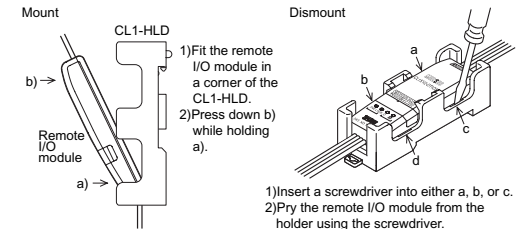

4. Connection to External Equipment

4.1 External wiring

The input terminals of the CL1X2-D1D3S operate while using the power supplied from the interface. When connecting a sensor to the input terminal, use a sensor of the NPN open collector transistor type.

Input wiring

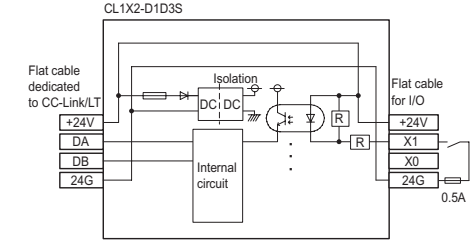

4.2 Connection to sensor

- When using a two-wire type sensor
- When using a three-wire type sensor

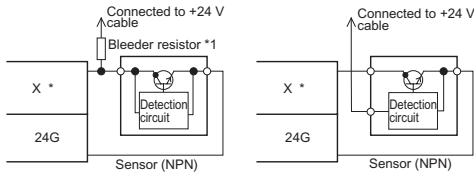

Replace * in the figure with the used input No.

Notes:

*1 Bleeder resistor

When connecting a two-wire type sensor or input equipment having parallel resistor, select a sensor or equipment whose leakage current is 1.7mA or less.

If the leakage current is more than 1.7mA, connect a bleeder resistor obtained in the following calculation formula.

Circuit image

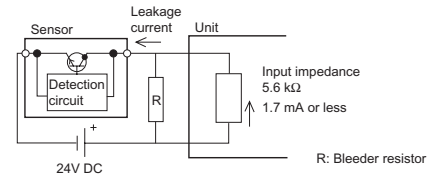

$$R(k\Omega) < 1.7(mA) / \text{Leakage current}(mA) - 1.7(mA) \times 5.6(k\Omega)$$

The power capacity W of the bleeder resistor R is as follows:

$$W = (\text{Input voltage})^2/R$$

- If chattering is present in the external input equipment, set 1.5ms.
 - If the ON or OFF time of the input signal is less than 1.5 ms, set it to 0.5 ms. (The ON and OFF time of the input signal are required to be 0.5 ms or more.)
- When setting 1.5 ms:
Set both the ON and OFF time of the input signal to 1.5 ms or more.
- When setting 0.5 ms:
Set both the ON and OFF time of the input signal to 0.5 ms or more.

5. Specifications

5.1 General specifications

Item	Specification			
Ambient working temperature	0 to 55°C (32 to 131°F) (*1)			
Ambient storage temperature	-25 to 75°C (-13 to 167°F) (*1)			
Ambient operating humidity	Conforming to JIS B3502 and IEC61131-2. Level RH-2 (5 to 95%RH: Dew condensation shall not be considered.)			
Ambient storage humidity	Conforming to JIS B3502 and IEC61131-2. Level RH-2 (5 to 95%RH: Dew condensation shall not be considered.)			
Vibration resistance	Conforming to JIS B3502 and IEC61131-2	When intermittent vibration is present		
		Frequency	Acceleration	Half amplitude
	10 to 57Hz	-	0.075mm	
	57 to 150Hz	9.8m/s ²	-	
Number of times of sweep	When continuous vibration is present		10 times in each of X, Y and Z directions (for 80 min)	
	Frequency	Acceleration		Half amplitude
	10 to 57Hz	-		0.035mm
	57 to 150Hz	4.9m/s ²		-
Impact resistance	Conforming to JIS B3502 and IEC61131-2 (147 m/s ² , 3 times in each of X, Y and Z directions)			
Operating atmosphere	Corrosive gas shall not be present.			
Operating altitude	Conforming to JIS B3502 and IEC61131-2 (2,000m(6561'8") or less)(*2)			
Installation place	Inside control panel (*3)			
Over-voltage category	Conforming to JIS B3502 and IEC61131-2 (Category II or less)(*4)			
Degree of contamination	Conforming to JIS B3502 and IEC61131-2, Degree of contamination 2 or less (*5)			

Notes:

- *1 The ambient operating/storage temperature satisfies the requirements beyond the specification in the JIS B3502 and the IEC61131-2.
- *2 The module cannot be used in an environment pressurized above the atmospheric pressure which can be generated around the altitude of 0 m. If the module is used in such an environment, it may fail.
- *3 The module can be used in any environment even outside the control panel as far as the requirements of the ambient operating temperature, the ambient operating humidity, etc. are satisfied.
- *4 This indicates the section of the power supply to which the equipment is assumed to be connected between the public electrical power distribution network and the machinery within premises. Category II applies to equipment for which electrical power is supplied from fixed facilities. The surge voltage withstand level for up to the rated voltage of 300V is 2500V.
- *5 This index indicates the degree of conductive generating substances in the environment in which the module is used. The degree of contamination 2 indicates that contamination is caused by generation of only non-conductive substances. In this degree, however, temporary conduction may be caused by accidental condensation.

5.2 Input specifications

Item	Specification	
Input method	DC input (using module power supply in common) EN61131-2, Section3.3.1.2-Type1	
Number of inputs	2 points	
Isolation method	Isolation with photocoupler	
Rated input voltage	24V DC	
Rated input current	Approx. 4 mA	
Operating voltage range	Same as module power supply	
Max. simultaneous ON input points	100% (at 24V DC)	
ON voltage/ON current	19 V or more/3 mA or more	
OFF voltage/OFF current	11 V or less/1.7 mA or less	
Input resistance	5.6 kΩ	
Response time	OFF→ON	0.5ms/1.5ms or less (at 24V DC) Selected by DIP switch (default value = OFF/1.5ms).
	ON→OFF	0.5ms/1.5ms or less (at 24V DC) Selected by DIP switch (default value = OFF/1.5ms).
Common wiring method	2 point/1 common (1 point)	

5.3 Performance specifications

Item	Specification	
Module power supply	Voltage	20.4 to 28.8V DC (24V DC -15% to +20%) Ripple ratio: Within 5%
	Current consumption	40mA (when all points are ON) (Current consumption does not contain the input current.)
	Initial current	70mA
	Max. allowable momentary power failure period	PS1:1ms
Number of stations occupied	4-, 8- or 16-point mode: 1 station	
Noise durability	500Vp-p Noise width: 1μs Cycle: 25 to 60 Hz (by noise simulator)	
Withstand voltage	500V AC for 1 min	
Isolation resistance	10 MΩ or more between primary area (external DC terminal) and secondary area (internal circuit) by 500V DC megger	
Protection class	IP2X	
I/O part connection method	Connection with cable	
Module installation method	Can be installed in six directions	
Flat cable for I/O (wire diameter)	AWG18 (34/0.18)	
Mass (weight)	0.07 kg (0.15 lbs) (including 500mm(19.69") flat cable dedicated to CC-Link/LT and 500mm(19.69") flat cable for I/O)	

6. Outside Dimensions

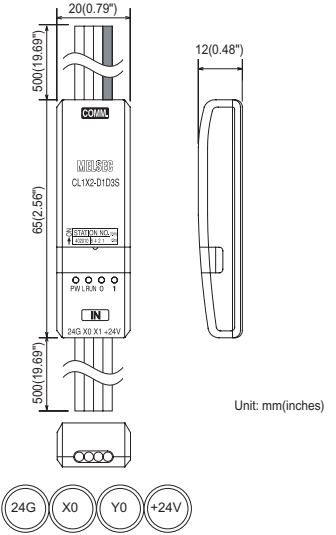

Unit: mm(inches)

Warranty

Mitsubishi will not be held liable for damage caused by factors found not to be the cause of Mitsubishi; machine damage or lost profits caused by faults in the Mitsubishi products; damage, secondary damage, accident compensation caused by special factors unpredictable by Mitsubishi; damages to products other than Mitsubishi products; and to other duties.

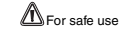

- For safe use
- This product has been manufactured as a general-purpose part for general industries, and has not been designed or manufactured to be incorporated in a device or system used in purposes related to human life.
- Before using the product for special purposes such as nuclear power, electric power, aerospace, medicine or passenger movement vehicles, consult with Mitsubishi.
- This product has been manufactured under strict quality control. However when installing the product where major accidents or losses could occur if the product fails, install appropriate backup or failsafe functions in the system.

Country/Region	Sales office/Tel	Country/Region	Sales office/Tel
U.S.A	Mitsubishi Electric Automation Inc. 500 Corporate Woods Parkway Vernon Hills, IL 60061 Tel : +1-847-478-2100 MELCO-TEC Rep. Com.e Assessoria Tecnica Ltda. Av. Rio Branco, 123-15, and S/1507, Rio de Janeiro, RJ CEP 20040-005, Brazil Tel : +55-21-221-8343	China	Ryoden International Shanghai Ltd. 3F Blocks Building Automation Instrumentation Plaza 103 Cao Bao Rd. Shanghai 200233 China Tel : +86-21-6475-3228
Brazil	Mitsubishi Electric Europe B.V. German Branch Golfaer Strasse 8 D-40880 Ratingen, GERMANY Tel : +49-2102-486-0	Taiwan	Setsumo Enterprise Co., Ltd. 6F, No.105 Wu-Kung 3rd RD, Wu-Ku Hsiang, Taipei Hsin, Taiwan Tel : +886-2-2299-2499
Germany	Mitsubishi Electric Europe B.V. UK Branch Travellers Lane, Hatfield, Herts., AL10 8BX, UK Tel : +44-1707-276100	Korea	HAN NEUNG TECHNO CO. LTD. 1F Dong Seo Game Channel Bldg, 660-11, Deungchon-dong Kangseck-ku, Seoul, Korea Tel : +82-2-3660-9552
U.K	Mitsubishi Electric Europe B.V. Italian Branch Centro Dir. Coleoni, Pal. Perseo - Ingr 2 Via Paracelso 12, 20041 Agrate B., Milano, Italy Tel:+39-039-60531	Singapore	Mitsubishi Electric Asia Pte. Ltd. 307 ALEXANDRIA ROAD #05-01/02, MITSUBISHI ELECTRIC BUILDING SINGAPORE159943 Tel : +65-473-2480
Italy	Mitsubishi Electric Europe B.V. Spanish Branch Carretera de Rubi 76-80 08190 - Sant Cugat del Valles, Barcelona, Spain Tel:+34-935-653135	Thailand	F. A. Tech Co. Ltd. 898/28,29,30 S.V.City Building,Office Tower 2, Floor 17-18 Rama 3 Road, Bangkokpooang, Yamawa, Bangkok 10120 Tel : +66-2-682-6522
Spain	Circuit Breaker Industries LTD. Private Bag 2016, Isando 1600, Johannesburg, South Africa Tel : +27-11-928-2000	Indonesia	PT. Autoteknindo SUMBER MAKMUR Jl. Muara Karang Selatan Block4 Utara No.1 Kav. No.11 KawasanIndustri/ PergudanganJakarta - Utara 14440 Tel : +62-21-663-0833
South Africa	Ryoden Automation Ltd. 10th Floor, Manulife Tower, 169 Electric Road, North Point, HongKong Tel : +852-2987-8870	India	Messung Systems Pvt.Ltd. Electronic Sadan NO:111 Unit No15, M.I.D.C BHOSARI,PUNE-411026 Tel : +91-20-7128927
Hong Kong		Australia	Mitsubishi Electric Australia Pty. Ltd. 348 Victoria Road, PostalBag, No.2, Rydalmere, N.S.W 2116, Australia Tel : +61-2-9684-7777

MITSUBISHI ELECTRIC CORPORATION
HEAD OFFICE : MITSUBISHI DENKI BLDG MARUNOUCHI TOKYO 100-8310 TELEX:24532 CABLE MELCO TOKYO
HIMEJI WORKS : 840 CHIVODA CHO, HIMEJI, JAPAN

When exported from Japan, this manual does not require application to the Ministry of Economy, Trade and Industry for service transaction permission.

Specifications are subject to change without notice

