

GOT1000

GT1020/GT1030 to FR-D700 Inverter

Start-up Guide

About this Manual

The texts, illustrations, diagrams and examples in this manual are only intended as aids to help explain the functioning, operation, use and programming of the GOT1000 terminals in combination with an FR-D700 Inverter.

If you have any questions regarding the installation and operation of the hardware described in this manual, please do not hesitate to contact your sales office or one of your Mitsubishi distribution partners.



CAUTION:

Do not attempt to install, operate, maintain or inspect the graphical operator terminal or the inverter until you have read through the corresponding instruction manual carefully and can use the equipment correctly. Do not use the inverter until you have a full knowledge of the equipment, safety information and instructions.

You can also obtain information and answers to frequently asked questions from our Mitsubishi website under www.mitsubishi-automation.com.

No part of this manual may be reproduced, copied, stored in any kind of information retrieval system or distributed without the prior express written consent of MITSUBISHI ELECTRIC.

MITSUBISHI ELECTRIC reserves the right to change the specifications of its products and/or the contents of this manual at any time and without prior notice.

© Version A March 2010

Manual References:

Refer to the following manuals for more detailed explanations. For any further questions, please contact your local Mitsubishi Product Provider.

- GOT1000 Series Connection Manual 3/3 (SH(NA)-080532ENG), Sections 37.1 to 37.6
- FR-D700 Inverter Instruction Manual, art. no 226857



CAUTION:

This Start-up Guide includes a brief summary of the main specifications of the GOT1000 graphic operation terminals and the FR-D700 series of inverters, which should be sufficient to enable experienced users to install and configure the units. For further information on the operation terminals and the inverters please refer to the above mentioned manuals.

Please observe also the safety precautions given in the manuals mentioned above.

Table of Contents

1	Overview	1-1
2	Hardware Introduction	1-1
3	Cabling	1-2
	3.1 GOT and Inverter Wiring Diagrams	1-3
	3.2 GOT Terminals	1-4
	3.3 Programming Cables	1-4
4	GT Designer 2	1-5
5	Inverter Settings	1-7
6	Station Setting	1-7
	6.1 Indirect Specification	1-8
7	Confirm Communication	1-8

1 Overview

This document provides a simple guide to setting up the GT1020 or GT1030 Graphic Operation Terminal (GOT) hardware and firmware for use with an FR-D700 Inverter.

2 Hardware Introduction

The GT1020 and GT1030 are monochrome, 3-color backlight, two communication channel GOT1000 Series touch panel interfaces used for capturing user input to a system.

It should be noted that not all products from the GT1020 or GT1030 range are compatible with a FREQROL inverter connection. Compatible products are identified in the table below.

Model		Size	Backlight Colors	Comm. IF	Power
GT1020	-LBD	3.7" 160 x 64 dot	Green/Orange/Red	RS422	24 V DC
	-LBDW		White/Pink/Red		
GT1030	-LBD	4.5" 288 x 96 dot	Green/Orange/Red		
	-LBDW		White/Pink/Red		

Tab. 1: Specifications of the operator terminals



For new GT1020 and GT1030 units, included in the box should be the following items:

- (A) GT1020/GT1030
- (B) 1 PLC Communication Connector
- (C) 1 rubber Panel Mounting Packing
- (D) 4 Panel Mounting Brackets

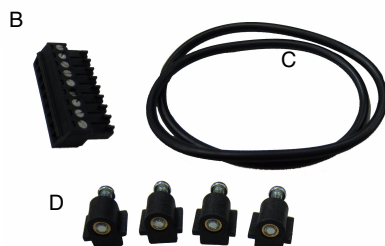

3 Cabling

Power

The applicable GT1020/GT1030 GOTs require an external 24V DC power supply to be connected to the Power Terminal on the back of the GOT.

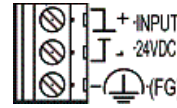

Communication

For the GT1020/GT1030 to communicate with the inverter, a communication cable is required. The type of cable used is dependent on the number of inverters used within the system, examples of which are illustrated below.

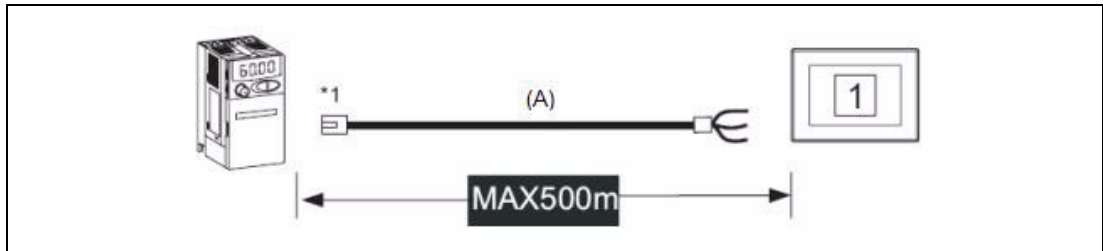

Fig. 1: One inverter connection

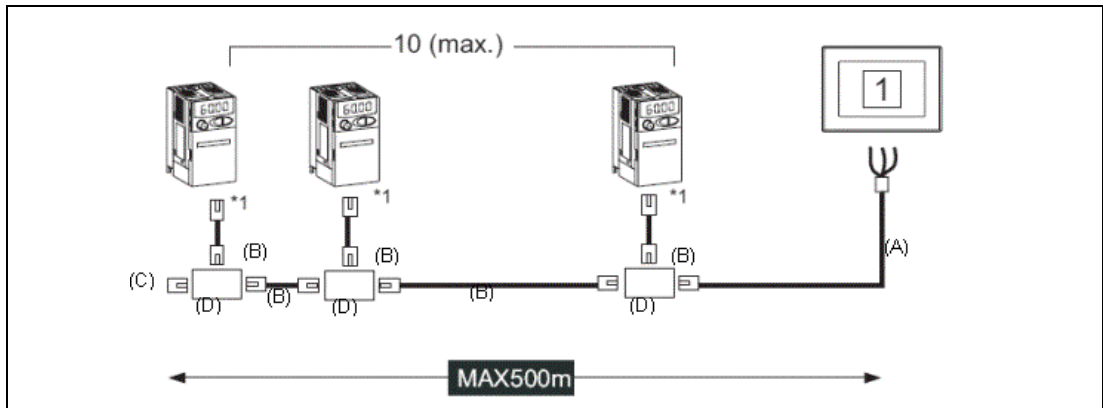

Fig. 2: Multi-drop connection

*1 Connect to the PU port of the inverter.

Discription to Fig. 2:

	A	B	C	D
Detailed view				
Standard	RS422	RS422	RS422	RS422
Meaning	Between inverter and GOT (to be made by user)	Between distributor and inverter or between distributors	Terminating resistor	Distributor

For an explanation of the communication cables please refer to the following section 3.1.

3.1 GOT and Inverter Wiring Diagrams

GOT side (terminal block)	Cable connection and signal direction	Inverter side or distributor side (Modular connector)		
Signal name		Pin No.	Signal name	Pin layout ^①
SDA		3	RDA	
SDB		6	RDB	
RDA		5	SDA	
RDB		4	SDB	
SG		1	SG	
RSA		2	P5S	
RSB	7	SG		
CSA	8	P5S		
CSB				

Tab. 2: RS-422 connection between inverter and GOT (Cable type A)

Distributor side (Modular connector)			Cable connection and signal direction	Inverter side or distributor side (Modular connector)		
Pin layout ^①	Signal name	Pin No.		Pin No.	Signal name	Pin layout ^①
	SDA	5		5	SDA	
	SDB	4		4	SDB	
	RDA	3		3	RDA	
	RDB	6		6	RDB	
	P5S	2		2	P5S	
	P5S	8		8	P5S	
	SG	1		1	SG	

Tab. 3: RS-422 connection distributor and inverter (Cable type B)

Distributor side			Cable connection and signal direction
Pin layout ^①	Signal name	Pin No.	
	SDA	5	
	SDB	4	
	RDA	3	
	RDB	6	
	P5S	2	
	P5S	8	
SG	1		

Tab. 4: RS-422 connection for mounting a terminating resistor (Cable type C)

① The connector figure shows the engagement face.

3.2 GOT Terminals

The GT1020/GT1030 is fitted with screw terminals, use a small flathead screwdriver to secure the wires within the PLC Communication Connector.

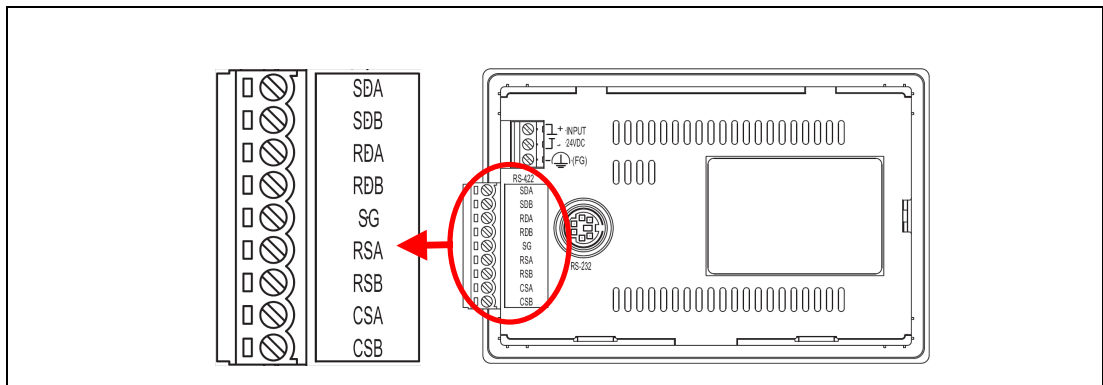

Fig. 3: Terminal points in detail

3.3 Programming Cables

The GT1020 and GT1030 come pre-installed with an OS and FX communication driver, but without any project data. To download a project from a PC running GT Designer2 to the GOT, a programming cable is required that connects to the RS-232C 6-pin Mini-DIN port on the back of the GOT. It is recommended to use a shielded USB A-type to Mini-B type cable with a ferrite core paired with the GT10-RS2TUSB-5S, but any RS-232C programming cable for the Q-Series will also work fine. A diagram of both is shown below.

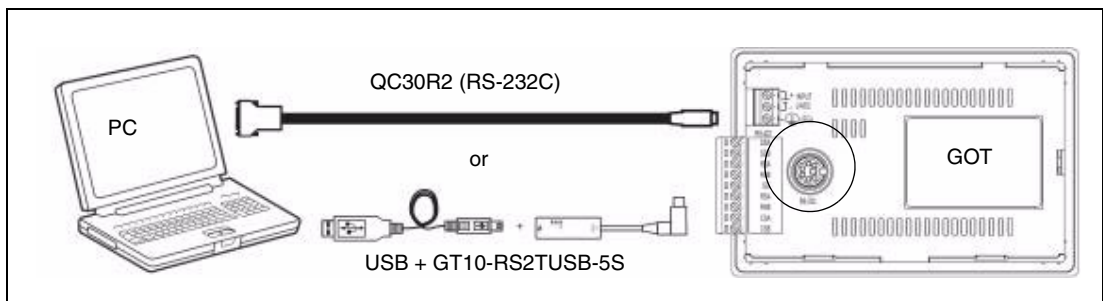

Fig. 4: Connection diagram

NOTE

Note that using the GT10-RS2TUSB-5S will require a virtual USB COM port driver to be installed on the PC. The COM port number can be automatically or manually assigned so that it does not overlap with the existing COM port numbers assigned on that PC. When using a Q-Series programming cable, the COM port number already assigned to the RS-232C interface of the PC will have to be checked.

4 GT Designer 2

(Version 2.73 or later)

To make sure the GT1020/GT1030 GOT is able to use the latest functions and features, it is the responsibility of the user to check and update the firmware (Standard monitor OS) of the GOT.

Launch the latest copy of GT Designer2 and start a new project for the corresponding GOT model (GT1020 or GT1030) with the “FREQROL500/700” Inverter Type. Select **Yes** to set the Communication Setting and make sure the Standard I/F-1 CH No. is set to 1 before selecting **OK**. The “Screen Property” window that pops up for making a new screen can be either canceled or accepted for the following steps.

Go to the “Communication” menu and select “To/From GOT” to bring up the “Communicate with GOT” window. Go to the “Communication configuration” tab and select “RS232” and the corresponding “Port No.” that connects the PC to the GOT. With the GOT power ON, use the **Test** button to verify that the PC and GOT can communicate properly then turn the GOT power OFF.

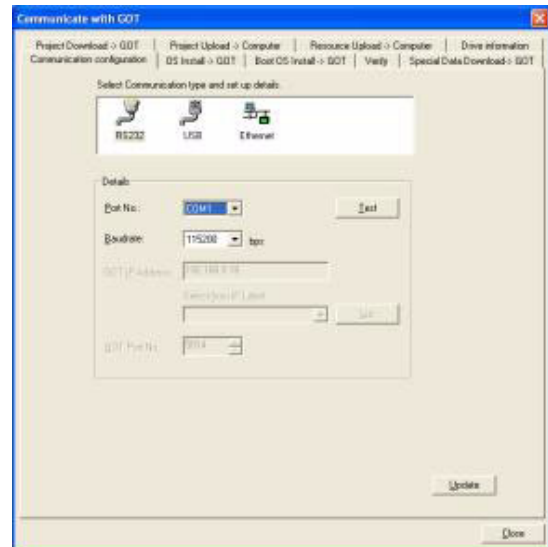

Installing OS and communication drivers

To access the OS installation mode of the GT1020/GT1030, switch the GOT power from OFF to ON, while holding the bottom right corner of the touch screen (in horizontal layout), illustrated in the figure at the right.

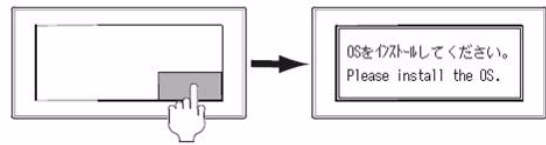

While the “Please install the OS” screen is displayed, go to the “OS Install -> GOT” tab in the “Communicate with GOT” window of GT Designer2 and select “Standard monitor OS” and select ‘FREXROL 500/700’ from the ‘Communication Driver’ menu. Use the **Install** button to initiate the data transfer and update the firmware. Once the firmware update has been completed the GOT will automatically reboot and all features will be up to date. Note that new project data will need to be downloaded to the GOT.

Make a selection like viewed on the right side under communication driver.

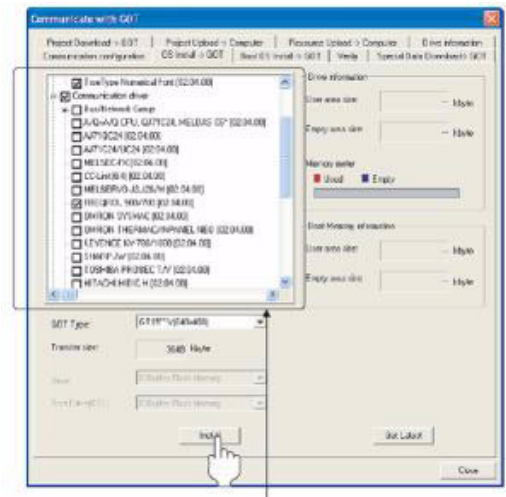

5 Inverter Settings

When setting the inverter communication parameters it is important to reset the power afterwards so that the settings are saved to the inverter.

The parameters shown in the following table must be set using the PU (Parameter Unit).

NOTE

Do not change these parameters, even though it is possible to monitor them through the GOT. If they are changed, communication with the GOT is disabled.

Setting item	Parameter	Set Value	Setting Contents
Communication station number	Pr.117	0 to 31	See following section
Communication speed	Pr.118	192	19200 bps
Stop bit length	Pr.119	10	Data length: 7 bit Stop bit length: 1 bit
Parity check	Pr.120	1	Odd
Number of communication retries	Pr.121	9999	The inverter will not come to an alarm stop.
Communication check time interval	Pr.122	9999	Communication checkSuspension
Wait time setting	Pr.123	0	0ms
CR/LF selection	Pr.124	1	With CR, without LF
Protocol selection	Pr.549	0	Mitsubishi inverter protocol
Operation mode selection	Pr.79	0	PU operation mode
Communication startup mode selection	Pr.340	1	Network operation mode
EEPROM write selection	Pr.342	0	Written to RAM and EEPROM

Tab. 5: Inverter setting parameters

6 Station Setting

Set each station number while making sure that each station number is used only once.

The station number can be set regardless of the cable connection order.

Station numbers do not have to be consecutive.

The setting of the station number has to be between 0 and 31.

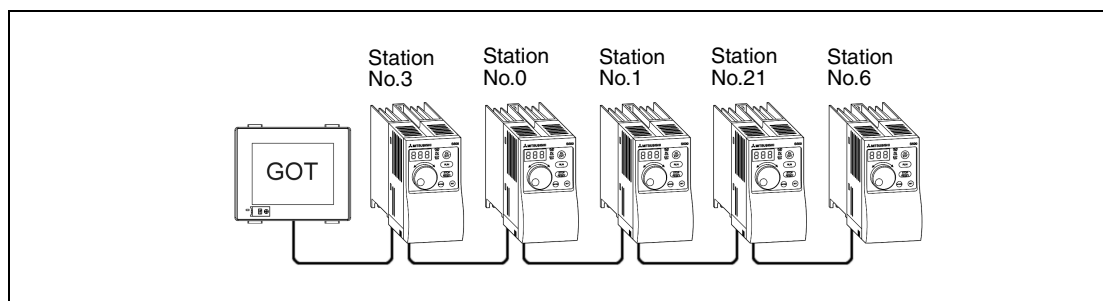

Fig. 5: Examples of station number setting

6.1 Indirect Specification

When setting the station number indirectly, the station number of the inverter can be changed using the 16-bit GOT internal data register (GD10 to GD25). When specifying the station number from 100 to 155 on GT Designer 2, the value within GD10 to GD25 is equal to the station no.

Specification station no.	Compatible Device	Setting range
100	GD10	0 to 31 If the associated device contains a value outside this range an error (dedicated device is out of range) will occur.
101	GD11	
102	GD12	
103	GD13	
104	GD14	
105	GD15	
106	GD16	
107	GD17	
108	GD18	
109	GD19	
110	GD20	
111	GD21	
112	GD22	
113	GD23	
114	GD24	
115	GD25	

Tab. 6: Specification of the station number

7 Confirm Communication

The communication monitoring is a function that checks whether the GOT can communicate with the Inverter. If no error is shown, communication has been set up correctly.

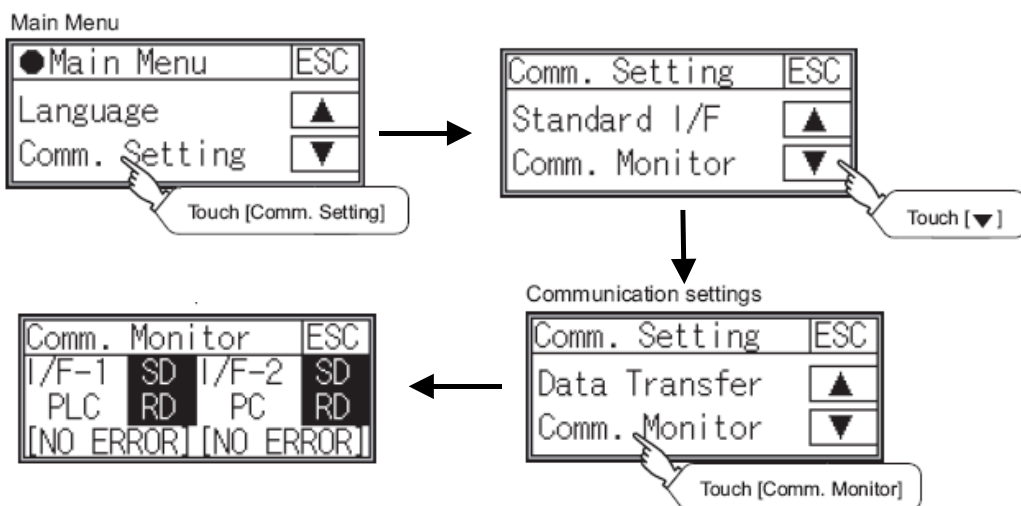

HEADQUARTERS

MITSUBISHI ELECTRIC EUROPE B.V. **EUROPE**
 German Branch
 Gothaer Straße 8
D-40880 Ratingen
 Phone: +49 (0)2102 / 486-0
 Fax: +49 (0)2102 / 486-1120

MITSUBISHI ELECTRIC EUROPE B.V. **CZECH REPUBLIC**
 Czech Branch
 Avenir Business Park, Radlická 714/113a
CZ-158 00 Praha 5
 Phone: +420 - 251 551 470
 Fax: +420 - 251-551-471

MITSUBISHI ELECTRIC EUROPE B.V. **FRANCE**
 French Branch
 25, Boulevard des Bouvets
F-92741 Nanterre Cedex
 Phone: +33 (0)1 / 55 68 55 68
 Fax: +33 (0)1 / 55 68 57 57

MITSUBISHI ELECTRIC EUROPE B.V. **IRELAND**
 Irish Branch
 Westgate Business Park, Ballymount
IRL-Dublin 24
 Phone: +353 (0)1 4198800
 Fax: +353 (0)1 4198890

MITSUBISHI ELECTRIC EUROPE B.V. **ITALY**
 Italian Branch
 Viale Colleoni 7
I-20041 Agrate Brianza (MB)
 Phone: +39 039 / 60 53 1
 Fax: +39 039 / 60 53 312

MITSUBISHI ELECTRIC EUROPE B.V. **POLAND**
 Poland Branch
 Krakowska 50
PL-32-083 Balice
 Phone: +48 (0)12 / 630 47 00
 Fax: +48 (0)12 / 630 47 01

MITSUBISHI ELECTRIC EUROPE B.V. **SPAIN**
 Spanish Branch
 Carretera de Rubí 76-80
E-08190 Sant Cugat del Vallés (Barcelona)
 Phone: 902 131121 // +34 935653131
 Fax: +34 935891579

MITSUBISHI ELECTRIC EUROPE B.V. **UK**
 UK Branch
 Travellers Lane
UK-Hatfield, Herts. AL10 8XB
 Phone: +44 (0)1707 / 27 61 00
 Fax: +44 (0)1707 / 27 86 95

MITSUBISHI ELECTRIC CORPORATION **JAPAN**
 Office Tower "Z" 14 F
 8-12, 1 chome, Harumi Chuo-Ku
Tokyo 104-6212
 Phone: +81 3 622 160 60
 Fax: +81 3 622 160 75

MITSUBISHI ELECTRIC AUTOMATION, Inc. **USA**
 500 Corporate Woods Parkway
Vernon Hills, IL 60061
 Phone: +1 847 478 21 00
 Fax: +1 847 478 22 53

EUROPEAN REPRESENTATIVES

GEVA **AUSTRIA**
 Wiener Straße 89
AT-2500 Baden
 Phone: +43 (0)2252 / 85 55 20
 Fax: +43 (0)2252 / 488 60

TEHNIKON **BELARUS**
 Oktyabrskaya 16/5, Off. 703-711
BY-220030 Minsk
 Phone: +375 (0)17 / 210 46 26
 Fax: +375 (0)17 / 210 46 26

ESCO DRIVES & AUTOMATION **BELGIUM**
 Culliganlaan 3
BE-1831 Diegem
 Phone: +32 (0)2 / 717 64 30
 Fax: +32 (0)2 / 717 64 31

Koning & Hartman b.v. **BELGIUM**
 Woluwelaan 31
BE-1800 Vilvoorde
 Phone: +32 (0)2 / 257 02 40
 Fax: +32 (0)2 / 257 02 49

INEA BH d.o.o. **BOSNIA AND HERZEGOVINA**
 Aleja Lipa 56
BA-71000 Sarajevo
 Phone: +387 (0)33 / 921 164
 Fax: +387 (0)33 / 524 539

AKHNATON **BULGARIA**
 4 Andrej Ljapchev Blvd. Pb 21
BG-1756 Sofia
 Phone: +359 (0)2 / 817 6004
 Fax: +359 (0)2 / 97 44 06 1

INEA CR d.o.o. **CROATIA**
 Losinjska 4 a
HR-10000 Zagreb
 Phone: +385 (0)1 / 36 940 -01 / -02 / -03
 Fax: +385 (0)1 / 36 940 -03

AutoCont C.S. s.r.o. **CZECH REPUBLIC**
 Technologická 374/6
CZ-708 00 Ostrava-Pustkovce
 Phone: +420 595 691 150
 Fax: +420 595 691 199

B:ELECTRIC, s.r.o. **CZECH REPUBLIC**
 Mladoboleslavská 812
CZ-197 00 Praha 19 - Kbely
 Phone: +420 286 850 848, +420 724 317 975
 Fax: +420 286 850 850

Beijer Electronics A/S **DENMARK**
 Lykkegårdsvej 17, 1.
DK-4000 Roskilde
 Phone: +45 (0)46 / 75 76 66
 Fax: +45 (0)46 / 75 56 26

Beijer Electronics Eesti OÜ **ESTONIA**
 Pärnu mnt.160i
EE-11317 Tallinn
 Phone: +372 (0)6 / 51 81 40
 Fax: +372 (0)6 / 51 81 49

Beijer Electronics OY **FINLAND**
 Jaakonkatu 2
FIN-01620 Vantaa
 Phone: +358 (0)207 / 463 500
 Fax: +358 (0)207 / 463 501

UTECO A.B.E.E. **GREECE**
 5, Mavrogenous Str.
GR-18542 Piraeus
 Phone: +30 211 / 1206 900
 Fax: +30 211 / 1206 999

MELTRADE Ltd. **HUNGARY**
 Fertő utca 14.
HU-1107 Budapest
 Phone: +36 (0)1 / 431-9726
 Fax: +36 (0)1 / 431-9727

Beijer Electronics SIA **LATVIA**
 Vestienas iela 2
LV-1035 Riga
 Phone: +371 (0)784 / 2280
 Fax: +371 (0)784 / 2281

Beijer Electronics UAB **LITHUANIA**
 Savanorių Pr. 187
LT-02300 Vilnius
 Phone: +370 (0)5 / 232 3101
 Fax: +370 (0)5 / 232 2980

EUROPEAN REPRESENTATIVES

ALFATRADE Ltd. **MALTA**
 99, Paola Hill
Malta- Paola PLA 1702
 Phone: +356 (0)21 / 697 816
 Fax: +356 (0)21 / 697 817

INTEHSIS srl **MOLDOVA**
 bld. Traian 23/1
MD-2060 Kishinev
 Phone: +373 (0)22 / 66 4242
 Fax: +373 (0)22 / 66 4280

HIFLEX AUTOM.TECHNIEK B.V. **NETHERLANDS**
 Wolweverstraat 22
NL-2984 CD Ridderkerk
 Phone: +31 (0)180 - 46 60 04
 Fax: +31 (0)180 - 44 23 55

Koning & Hartman b.v. **NETHERLANDS**
 Haarlbergweg 21-23
NL-1101 CH Amsterdam
 Phone: +31 (0)20 / 587 76 00
 Fax: +31 (0)20 / 587 76 05

Beijer Electronics AS **NORWAY**
 Postboks 487
NO-3002 Drammen
 Phone: +47 (0)32 / 24 30 00
 Fax: +47 (0)32 / 84 85 77

Sirius Trading & Services srl **ROMANIA**
 Aleea Lacul Morii Nr. 3
RO-060841 Bucuresti, Sector 6
 Phone: +40 (0)21 / 430 40 06
 Fax: +40 (0)21 / 430 40 02

Craft Con. & Engineering d.o.o. **SERBIA**
 Bulevar Svetog Cara Konstantina 80-86
SER-18106 Nis
 Phone: +381 (0)18 / 292-24-4/5
 Fax: +381 (0)18 / 292-24-4/5

INEA SR d.o.o. **SERBIA**
 Izletnicka 10
SER-113000 Smederevo
 Phone: +381 (0)26 / 617 163
 Fax: +381 (0)26 / 617 163

AutoCont Control s.r.o. **SLOVAKIA**
 Radlinského 47
SK-02601 Dolny Kubin
 Phone: +421 (0)43 / 5868210
 Fax: +421 (0)43 / 5868210

CS MTrade Slovensko, s.r.o. **SLOVAKIA**
 Vajanskeho 58
SK-92101 Piestany
 Phone: +421 (0)33 / 7742 760
 Fax: +421 (0)33 / 7735 144

INEA d.o.o. **SLOVENIA**
 Stegne 11
SI-1000 Ljubljana
 Phone: +386 (0)1 / 513 8100
 Fax: +386 (0)1 / 513 8170

Beijer Electronics AB **SWEDEN**
 Box 426
SE-20124 Malmö
 Phone: +46 (0)40 / 35 86 00
 Fax: +46 (0)40 / 35 86 02

Omni Ray AG **SWITZERLAND**
 Im Schörl 5
CH-8600 Dübendorf
 Phone: +41 (0)44 / 802 28 80
 Fax: +41 (0)44 / 802 28 28

GTS **TURKEY**
 Bayraktar Bulvari Nutuk Sok. No:5
TR-34775 Yukari Dudullu-Umraniye-ISTANBUL
 Phone: +90 (0)216 526 39 90
 Fax: +90 (0)216 526 3995

CSC Automation Ltd. **UKRAINE**
 4-B, M. Raskovoyi St.
UA-02660 Kiev
 Phone: +380 (0)44 / 494 33 55
 Fax: +380 (0)44 / 494-33-66

EURASIAN REPRESENTATIVES

Kazpromautomatiks Ltd. **KAZAKHSTAN**
 Mustafina Str. 7/2
KAZ-470046 Karaganda
 Phone: +7 7212 / 50 11 50
 Fax: +7 7212 / 50 11 50

MIDDLE EAST REPRESENTATIVES

ILAN & GAVISH Ltd. **ISRAEL**
 24 Shenkar St., Kiryat Arie
IL-49001 Petah-Tiqva
 Phone: +972 (0)3 / 922 18 24
 Fax: +972 (0)3 / 924 0761

CEG INTERNATIONAL **LEBANON**
 Cebaco Center/Block A Autostrade DORA
Lebanon - Beirut
 Phone: +961 (0)1 / 240 430
 Fax: +961 (0)1 / 240 438

AFRICAN REPRESENTATIVE

CBI Ltd. **SOUTH AFRICA**
 Private Bag 2016
ZA-1600 Isando
 Phone: +27 (0)11 / 977 0770
 Fax: +27 (0)11 / 977 0761