

MITSUBISHI

GT16 Video/RGB Input Unit User's Manual

GT16M-V4
GT16M-V4R1
GT16M-R2

Thank you for purchasing the GOT1000 Series.

Prior to use, please read both this manual and detailed manual thoroughly to fully understand the product.

MODEL	GT16M-V4R1-U
MODEL CODE	1D7M85
IB(NA)-0800431-B(0901)MEE	

GRAPHIC OPERATION TERMINAL
GOT1000

SAFETY PRECAUTIONS

(Always read these precautions before using this equipment.)

Before using this product, please read this manual and the relevant manuals introduced in this manual carefully and pay full attention to safety to handle the product correctly.

The precautions given in this manual are concerned with this product.

In this manual, the safety precautions are ranked as "DANGER" and "CAUTION".

DANGER

Indicates that incorrect handling may cause hazardous conditions, resulting in death or severe injury.

CAUTION

Indicates that incorrect handling may cause hazardous conditions, resulting in medium or slight personal injury or physical damage.

Note that the CAUTION level may lead to a serious accident according to the circumstances.

Always follow the precautions of both levels because they are important to personal safety.

Please save this manual to make it accessible when required and always forward it to the end user.

DESIGN PRECAUTIONS

CAUTION

- Do not bunch the control wires or communication cables with the main circuit or power wires, or lay them close to each other. As a guide, separate the lines by a distance of at least 100 mm (3.94 inch). Otherwise malfunctions may occur due to noise.

INSTALLATION PRECAUTIONS

DANGER

- Be sure to shut off all phases of the external power supply used by the system before mounting or removing this unit to/from the GOT. Not doing so can cause a unit failure or malfunction.
- Before connecting the Bus connection cable to this unit, always shut off GOT power and PLC CPU power externally in all phases. Not doing so can cause a malfunction.

CAUTION

- Use this unit in the environment given in the general specifications of the GT16 User's Manual. Not doing so can cause an electric shock, fire, malfunction or product damage or deterioration.
- Do not drop the unit or subject it to string shock. A unit damage may result.
- When installing this unit to the GOT, fit it to the connection interface of the GOT and tighten the mounting screws in the specified torque range. Undertightening can cause a drop, failure or malfunction. Overtightening can cause a drop, failure or malfunction due to screw or unit damage.

WIRING PRECAUTIONS

DANGER

- Be sure to shut off all phases of the external power supply used by the system before wiring. Failure to do so may result in an electric shock, product damage or malfunctions.

CAUTION

- Exercise care to avoid foreign matter such as chips and wire offcuts entering the unit. Not doing so can cause a fire, failure or malfunction.
- Make sure to securely connect the cable to the connector of unit. Incorrect connection may cause malfunctions.

STARTUP AND MAINTENANCE PRECAUTIONS

DANGER

- Before starting cleaning, always shut off GOT power externally in all phases. Not doing so can cause a unit failure or malfunction. Undertightening can cause the GOT to drop, short circuit or malfunction. Overtightening can cause a short circuit or malfunction due to the damage of the screws or unit.
- Do not disassemble or modify any unit. This will cause failure, malfunction, injuries, or fire.
- Do not touch the conductive areas and electronic parts of this unit directly. Doing so can cause a unit malfunction or failure.

CAUTION

- Always secure the cables connected to the unit, e.g. run them in conduits or clamp them. Not doing so can cause unit or cable damage due to dangling, moved or accidentally pulled cables or can cause a malfunction due to a cable contact fault.
- Do not hold the cable part when unplugging any cable connected to the unit. Doing so can cause unit or cable damage or a malfunction due to a cable contact fault.
- Always make sure to touch the grounded metal to discharge the electricity charged in the body, etc., before touching the unit. Failure to do so may cause a failure or malfunctions of the unit.

DISPOSAL PRECAUTIONS

CAUTION

- Dispose of this product as industrial waste.

TRANSPORTATION PRECAUTIONS

CAUTION

- Make sure to transport the GOT main unit and/or relevant unit(s) in the manner they will not be exposed to the impact exceeding the impact resistance described in the general specifications of the GT16 User's Manual, as they are precision devices. Failure to do so may cause the unit to fail. Check if the unit operates correctly after transportation.

Manuals

The following shows manuals relevant to this product.

Detailed Manual

Manual name	Manual number (Model code)
GT16 User's Manual (Sold separately)	SH-080778ENG (1D7M88)
GOT1000 Series Connection Manual (1/3 to 3/3) (Sold separately)	SH-080532ENG (1D7M26)
GT Designer2 Version2 Screen Design Manual (For GOT1000 Series) (1/3 to 3/3) (Sold separately)	SH-080530ENG (1D7M25)

Relevant Manuals

For relevant manuals, refer to the PDF manuals stored in the GT Designer2 CD-ROM.

© 2008 MITSUBISHI ELECTRIC CORPORATION

Compliance with the EMC and Low Voltage Directives

When incorporating the Mitsubishi GOT into other machinery or equipment and keeping compliance with the EMC and low voltage directives, refer to "EMC AND LOW VOLTAGE DIRECTIVE" of GT16 User's Manual.

The CE logo is printed on the rating plate of the GOT, indicating compliance with the EMC and low voltage directives.

Packing List

After unpacking the box, check that the following products are included.

Model	Product	Quantity
GT16M-V4	Video input unit	1
	Mounting screw set (4 screws, 4 stickers)	1
	Extension interface relay board	1
GT16M-V4R1	Video/RGB input unit	1
	Mounting screw set (4 screws, 4 stickers)	1
	Extension interface relay board	1
GT16M-R2	RGB input unit	1
	Mounting screw set (4 screws, 4 stickers)	1
	Extension interface relay board	1

1. OVERVIEW

This User's Manual describes the following units. When mounting the following units with the GT16□□M, the GOT can display video images taken by a camcorder or a RGB screen.

- For the GT16M-V4 video input unit (hereinafter referred to as the video input unit), the GOT can display video images taken by up to four camcorders.
- For the GT16M-V4R1 video/RGB input unit (hereinafter referred to as the video/RGB input unit), the GOT can display video images taken by up to four camcorders or a RGB screen for up to one device for the RGB input.
- For the GT16M-R2 RGB input unit (hereinafter referred to as the RGB input unit), the GOT can display only one RGB screen by switching up to two video input channels.

For the video input with using the above units, the GOT can be used as a vision sensor monitor.

For the RGB input unit with using the above units, the units can be used as the RGB output type vision sensor.

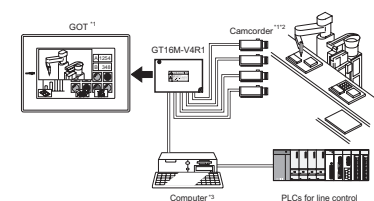

*1: Power on the GOT simultaneously with the camcorder.

*2: Depending on the camcorder type, noise from the power supply cable of the camcorder may cause malfunction of the GOT or a programmable controller.

In this case, attach the following line filter to the power supply line of the camcorder.

Recommended line filter: TDK ZHC2203-11 (or equivalent products)

*3: When connecting any of the above units to a personal computer, ground the ground cable of the personal computer.

To use the video input unit, video/RGB input unit, and RGB input unit set the communication settings.

For the settings and system configurations, refer to GOT1000 Series Connection Manual.

For video input and RGB input functions, refer to GT Designer2 Version□ Screen Design Manual.

2. SPECIFICATIONS

The performance specifications of the video input unit, video/RGB input unit, and RGB input unit are indicated below.

The general specifications of the video input unit, video/RGB input unit, and RGB input unit are the same as those of the GOT.

Refer to GT16 User's Manual for the general specifications of the GOT.

Item	Specifications		
	GT16M-V4	GT16M-V4R1	GT16M-R2
Video input section ^{*2}	Video input format	Color NTSC format, PAL format(interlaced format)	-
	Monochrome	EIA format, CCIR format (interlaced format)	-
	Number of video input channels	4 channel	-
	Input signal	1Vp-p, 75Ω, composite signal	-
	Display size (dot)	640x480 768x576, 720x480 ^{*1}	-
Connector for external connection	BNC connector		
RGB input section	RGB input method (dot)	-	Analog RGB(XGA; 1024x768, SVGA; 800x600, VGA; 640x480)
	Number of video input channels	-	1 channel 2 channels ^{*3}
	Input image signal	-	1Vp-p, 75Ω
	Synchronizing signal	-	TTL, 1kΩ
Display size (dot)	1024x768 (refresh rate 60Hz)		
	800x600 (refresh rate 60, 72, 75Hz) 640x480 (refresh rate 60, 72, 75, 85Hz)		
Connector for external connection	D-Sub15 pin: female		
Internal current consumption	3.3 VDC	0.32A	0.94A 0.75A
	5.0 VDC	0.12A	0.12A -
Weight	0.20kg (0.42lb)		
	0.22kg (0.46lb)		
	0.17kg (0.38lb)		

*1: Compatible with PAL and CCIR formats only.

*2: The GOT cannot display both video images and RGB screens at the same time.

*3: The GOT can display only one RGB screen.

3. PART NAMES AND EXTERNAL DIMENSIONS

3.1 Video/RGB Input Unit, Video Input Unit, and RGB Input Unit

The external dimensions for all the units are the same except the connector dimensions of the video input section and the RGB input section.

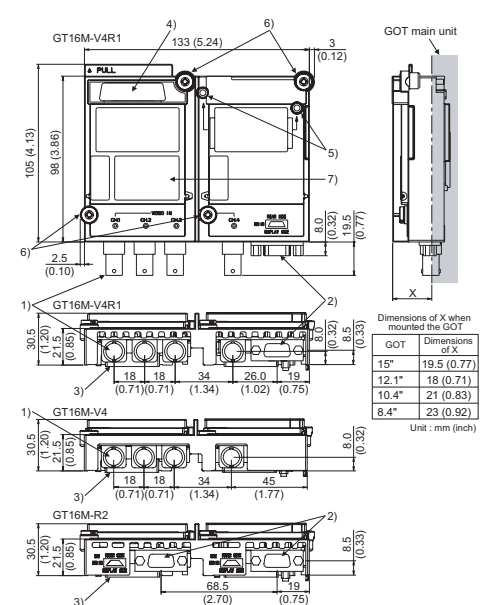

No.	Name	Description
1)	Connector for video input	Connector for connecting a coaxial cable
2)	Connector for RGB input	Connector for connecting 9-core combined cables
3)	Interface connector	Connector connected to the GOT
4)	Extension connector	Connector for connecting an extension unit
5)	Board fixing screw	Screw for fixing the extension interface relay board
6)	Mounting screw	Screw for fixing the unit
7)	Rating plate	-

3.2 Extension Interface Relay Board

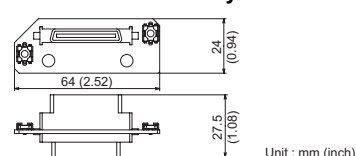

4. INSTALLATION PROCEDURE

1) Turn off the GOT.

2) Remove two extension unit covers of the GOT.

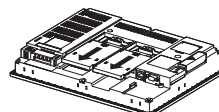

3) Connect the extension interface relay board to the extend interface2 side on the GOT.
Remove the connector cover from the board.

4) The connector for video input has the protection cap.
Remove the protection cap for the connector to be used.
(Store the removed protection cap.)

5) Fit the video/RGB input unit in the GOT case.

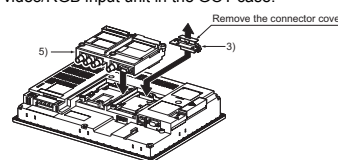

6) Tighten four mounting screws with a torque of 0.36 to 0.48N·m to fix the unit.

7) Tighten two board fixing screws with a torque of 0.36 to 0.48 N·m to fix the board.

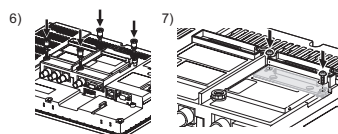

8) For mounting any extension unit on the unit, remove the connector cover and the stickers.

For mounting no extension unit on the unit, cover over four mounting screws with the accessory stickers to avoid static electricity.

Keep the connector cover fixed.
Keep all the stickers fixed.

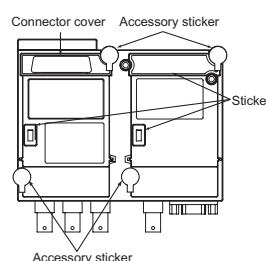

Point

Remove the screws that fixes the extension interface relay board before removing the unit. (Above 7)

MITSUBISHI ELECTRIC CORPORATION
HEAD OFFICE: TOKYO BUILDING, 2-7-3 MARUNOUCHI, CHYODA-KU, TOKYO 100-8310, JAPAN
NAGOYA WORKS: 1-14, YADA-MINAMI 5-CHOME, HIGASHI-KU, NAGOYA, JAPAN

When exported from Japan, this manual does not require application to the Ministry of Economy, Trade and Industry for service transaction permission.

Specifications subject to change without notice.
Printed in Japan.