

MITSUBISHI

GT15 CF card unit  
User's Manual

GT15-CFCD

Thank you for purchasing the GOT1000 Series.

Prior to use, please read both this manual and detailed manual thoroughly to fully understand the product.

MODEL	GT15-CFCD-U
MODEL CODE	1D7M62
IB(NA)-0800365-B(0611)MEE	

GRAPHIC OPERATION TERMINAL  
**GOT1000**

●SAFETY PRECAUTIONS●

(Be sure to read these instructions before use.)

Before using this product, read this and relevant manuals carefully and handle the product correctly with full attention to safety. Note that these precautions apply only to this product. In this manual, ●SAFETY PRECAUTIONS● are classified into 2 levels: "DANGER" and "CAUTION".

**DANGER** Indicates that incorrect handling may cause hazardous conditions, resulting in death or severe injury.

**CAUTION** Indicates that incorrect handling may cause hazardous conditions, resulting in medium or slight personal injury or physical damage.

Under some circumstances, failure to observe the CAUTION level instructions may also lead to serious accidents. Be sure to observe the instructions of both levels to ensure the safety. Please keep this manual in a safe place for future reference and also pass this manual on to the end user.

[Installation precautions]

**DANGER**

- Be sure to shut off all phases of the external power supply used by the system before mounting or removing this unit to/from the GOT. Not doing so can cause the unit to fail or malfunction.
- When installing this unit, wear a wrist strap to prevent the unit from being damaged by static electricity.
- Be sure to shut off all phases of the external power supply of the GOT main unit before connecting the cable to this unit. Not doing so can cause the unit to fail or malfunction.

**CAUTION**

- Use this unit under the environment specified in the GT15 User's Manual. Otherwise, it may cause electric shocks, fires, malfunctions, product deterioration or damage.
- When installing this unit, fit it to the connection interface of the GOT and tighten the mounting screws. If the screw is too loose, it may cause a drop of the unit, a failure or malfunctions. Tightening the screw excessively may damage the screw and/or the unit, resulting in a drop of the unit, a failure or malfunctions.
- When installing a CF card into this unit, insert it into the card slot of this unit until the CF card eject button pops out. Failure to do so may cause a malfunction due to poor contact.
- Before inserting or removing a CF card into/from this unit, turn the CF card access switch off. Failure to do so may corrupt data on the CF card.
- When removing a CF card from the GOT, support it by hand, as it may pop out. Failure to do so may cause the CF card to drop from the unit, resulting in a damage or failure.

[Wiring precautions]

**DANGER**

- Be sure to shut off all phases of the external power supply used by the system before wiring. Failure to do so may result in an electric shock, product damage or malfunctions.

**CAUTION**

- Carefully prevent foreign matter such as dust or wire chips from entering this unit. Failure to do so may cause a fire, failure or malfunctions.

[Startup and maintenance precautions]

**DANGER**

- Be sure to shut off all phases of the external power supply of the GOT main unit before starting cleaning. Not doing so can cause the unit to fail or malfunction.

**CAUTION**

- Do not disassemble or modify this unit and CF card. Doing so can cause failure, malfunctions, personal injuries and/or a fire.
- Do not touch the conductive and electronic parts of this unit directly. Doing so can cause a unit malfunction or failure.
- Do not drop or apply strong impact to this unit or the CF card. Doing so may damage the unit or CF card.
- Before handling this unit, touch a grounded metal object to discharge the static electricity from the human body. Failure to do so may cause failure or malfunctions of the unit.

[Disposal precautions]

**CAUTION**

- When disposing of the product, treat it as an industrial waste.

[Transportation precautions]

**CAUTION**

- Make sure to transport this unit in the manner it will not be exposed to the impact exceeding the impact resistance described in the general specifications of the GT15 User's Manual, as it is a precision device. Failure to do so may cause the unit to fail. Check if the unit operates correctly after transportation.

ABOUT MANUALS

The following shows manuals relevant to this product.

Detailed Manual	
Manual name	Manual number (Type code)
GT15 User's Manual (Sold separately)	SH-080528 (1D7M23)

Relevant Manuals

For relevant manuals, refer to the PDF manuals stored with the drawing software used.

© 2006 MITSUBISHI ELECTRIC CORPORATION

1. OVERVIEW

This User's Manual describes the GT15 CF card unit (hereinafter abbreviated as CF card unit). For the GOTs to which the units can be installed and usable CF cards, refer to the GT15 User's Manual. When using an additional drive, the CF card unit can be used as the B drive of the GOT. The extension units used as the B drive of the GOT are a CF card unit and a CF card extension unit. The CF card unit and the CF card extension unit cannot be used at once. After opening the box of the CF card unit, check that the following items are present.

Model name	Product name	Quantity
GT15-CFCD	CF card unit	1
	Screw set (2 screws)	1

To use the CF card unit, make the Communication Settings. For setting details, refer to the GT15 User's Manual.

2. SPECIFICATIONS

The performance specifications of the CF card unit are shown below.

Item	Specifications
Internal current consumption (5VDC)	0.07A
Protective structure	IP2X
Weight	0.15kg

For the general specifications of the CF card unit, refer to the GT15 User's Manual.

3. PART NAMES AND EXTERNAL DIMENSIONS

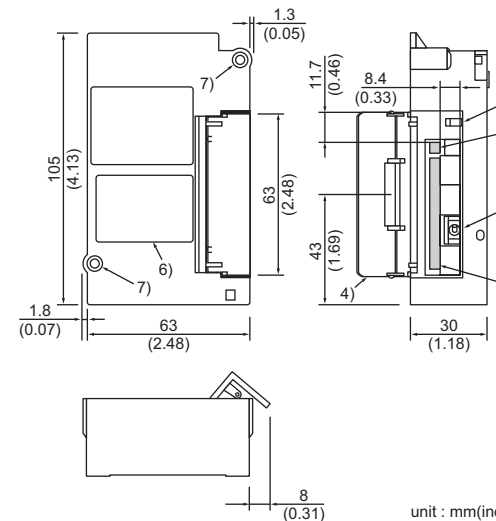

No.	Name	Description
1)	CF card access LED	LED lamp lit when the CF card is accessed
2)	CF card access switch	Switch for disabling the access to the CF card ON: Access to the CF card enabled OFF: Access to the CF card disabled
3)	Eject button	Button for removing the CF card
4)	CF card cover	Cover opening/closing at CF card installation/removal
5)	CF card connector	Connector for installing the CF card
6)	Rating plate	-
7)	CF card unit fixing screw	Mounting screw fixed with a front extension unit or the GOT

4. INSTALLATION PROCEDURE

4.1 CF Card Unit Installation

- 1) Power off the GOT.
- 2) Remove one of the extension unit covers of the GOT and fit the CF card unit along the groove of the GOT case.

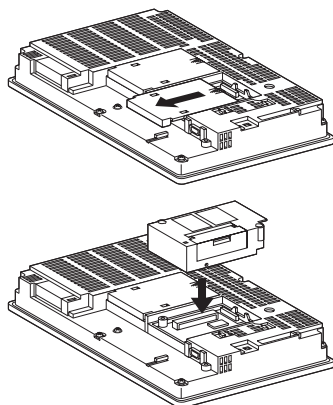

- 3) Fix the CF card unit by tightening its fixing screws (2 places) with a tightening torque of 0.36 to 0.48N·m.

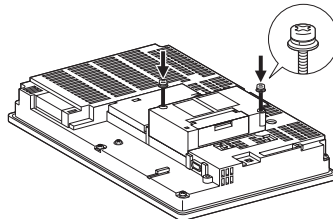

4.2 Installation and Removal Precautions

- (1) Any extension units cannot be installed on the CF card unit. When installing other extension units, install the CF card unit at the last.
- (2) When installing the CF card unit on extension interface 1 (left side), do not install more units on extension interface 2 (right side) than on extension interface 1 (left side). If doing so, the CF card cannot be installed or removed.
- (3) When removing the CF card unit, detach it from the specified direction (&trianglePULL) so as not to break the connector.

5. CF CARD INSTALLATION/REMOVAL PROCEDURE

5.1 Installation

- 1) Open the CF card cover and turn off the CF card access switch of the unit.

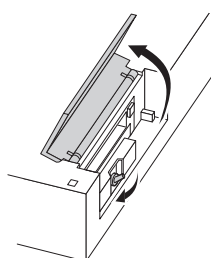

- 2) Insert the CF card into the CF card connector with the face out.

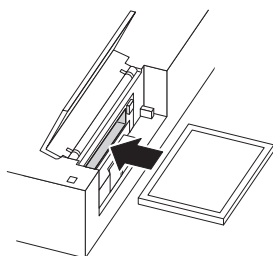

- 3) Turn on the CF card access switch.

5.2 Removal

- 1) Open the CF card cover. Turn off the CF card access switch and check that the CF card access LED turns off. (When the CF card access LED turns off, the CF card can be removed even while the GOT power is on.)

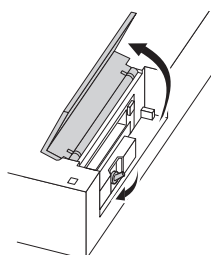

- 2) Press the CF card eject button to pop out the CF card and remove it.

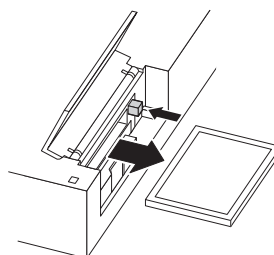

WARRANTY

Mitsubishi will not be held liable for damage caused by factors found not to be the cause of Mitsubishi; machine damage or lost profits caused by faults in the Mitsubishi products; damage, secondary damage, accident compensation caused by special factors unpredictable by Mitsubishi; damages to products other than Mitsubishi products; and to other duties.

FOR SAFE USE

- This product has been manufactured as a general-purpose part for general industries, and has not been designed or manufactured to be incorporated in a device or system used in purposes related to human life.
- Before using the product for special purposes such as nuclear power, electric power, aerospace, medicine or passenger movement vehicles, consult with Mitsubishi.
- This product has been manufactured under strict quality control. However, when installing the product where major accidents or losses could occur if the product fails, install appropriate backup or failsafe functions in the system.

Country/Region	Sales office/Tel
U.S.A	Mitsubishi Electric Automation Inc. 500 Corporate Woods Parkway Vernon Hills, IL 60061, U.S.A. Tel: +1-847-478-2100
Brazil	MELCO-TEC Resp. Com.e Assessoria Tecnica Ltda. Rua Correia Dias, 184, Edificio Paraiso Trade Center-8 andar Paraiso, Sao Paulo, SP Brazil Tel: +55-11-5908-8331
Germany	Mitsubishi Electric Europe B.V. German Branch Gothaer Strasse 8 D-40880 Ratingen, GERMANY Tel: +49-2102-486-0
U.K	Mitsubishi Electric Europe B.V. UK Branch Travellers Lane, Hatfield, Hertfordshire, AL10 8XB, U.K. Tel: +44-1707-276100
Italy	Mitsubishi Electric Europe B.V. Italian Branch Centro Dir. Colleoni, Pal. Perseo-Ingr.2 Via Paracelso 12, I-20041 Agrate Brianza., Milano, Italy Tel: +39-039-60531
Spain	Mitsubishi Electric Europe B.V. Spanish Branch Carretera de Rubi 76-80, E-08190 Sant Cugat del Valles, Barcelona, Spain Tel: +34-93-565-3131
France	Mitsubishi Electric Europe B.V. French Branch 25, Boulevard des Bouvets, F-92741 Nanterre Cedex, France TEL: +33-1-5568-5568
South Africa	Circuit Breaker Industries Ltd. Private Bag 2016, ZA-1600 Isando, South Africa Tel: +27-11-928-2000
Hong Kong	Mitsubishi Electric Automation (Hong Kong) Ltd. 10th Floor, Manulife Tower, 169 Electric Road, North Point, Hong Kong Tel: +852-2887-8870
China	Mitsubishi Electric Automation (Shanghai) Ltd. 4/F Zhi Fu Plaza, No.80 Xin Chang Road, Shanghai 200003, China Tel: +86-21-6120-0808
Taiwan	Setsuyo Enterprise Co., Ltd. 6F No.105 Wu-Kung 3rd.Rd, Wu-Ku Hsiang, Taipei Hsine, Taiwan Tel: +886-2-2299-2499
Korea	Mitsubishi Electric Automation Korea Co., Ltd. 1480-6, Gayang-dong, Gangseo-ku Seoul 157-200, Korea Tel: +82-2-3660-9552
Singapore	Mitsubishi Electric Asia Pte. Ltd. 307 Alexandra Road #05-01/02, Mitsubishi Electric Building, Singapore 159943 Tel: +65-6470-2460
Thailand	Mitsubishi Electric Automation (Thailand) Co., Ltd. Bang-Chan Industrial Estate No.111 Moo 4, Serithai Rd, T.Kannayao, A.Kannayao, Bangkok 10230 Thailand Tel: +66-2-517-1326
Indonesia	P.T. Autoteknindo Sumber Makmur Muara Karang Selatan, Block A/Utara No.1 Kav. No.11 Kawasan Industri Pergudangan Jakarta - Utara 14440, P.O.Box 5045, Jakarta, 11050 Indonesia Tel: +62-21-6630833
India	Messung Systems Pvt. Ltd. Electronic Sadan NO.III Unit No15, M.I.D.C.Bhosari, Pune-411026, India Tel: +91-20-2712-3130
Australia	Mitsubishi Electric Australia Pty. Ltd. 348 Victoria Road, Rydalmere, N.S.W 2116, Australia Tel: +61-2-9684-7777

MITSUBISHI ELECTRIC CORPORATION  
HEAD OFFICE : TOKYO BUILDING, 2-7-3 MARUNOUCHI, CHIYODA-KU, TOKYO 100-8310, JAPAN  
NAGOYA WORKS : 1-14, YADA-MINAMI 5-CHOME, HIGASHI-KU, NAGOYA, JAPAN

When exported from Japan, this manual does not require application to the Ministry of Economy, Trade and Industry for service transaction permission.

Specifications subject to change without notice.  
Printed in Japan on recycled paper.