

FX_{ON}

FX_{ON}-3A SPECIAL FUNCTION BLOCK

USER'S GUIDE

JY992D49001E

This manual contains text, diagrams and explanations which will guide the user in the correct installation and operation of the FX_{ON}-3A special function block and should be read and understood before attempting to install or use the unit. Further information can be found in the FX PROGRAMMING MANUAL(II), FX_{ON} /FX_{1N}/FX_{2N}/FX_{2NC} SERIES HARDWARE MANUAL.

1. Introduction

- The FX_{ON}-3A analog special function block has two input channels and one output channel. The input channels receive analog signals and convert them into digital values. The output channel takes a digital value and outputs an equivalent analog signal. The FX_{ON}-3A has a maximum resolution of 8 bits.
- The selection of voltage or current based input/output is decided by user wiring.
- An FX_{ON}-3A can be connected to the FX_{2N}, FX_{2NC}, FX_{1N} or FX_{ON} series of Programmable Controllers (Hereafter referred to as a PLC).
- All data transfers and parameter setups are adjusted through software control for the FX_{ON}-3A, via TO/FROM applied instructions in the PLC. Communications between the PLC and FX_{ON}-3A are protected by a photo-coupler.
- An FX_{ON}-3A occupies 8 I/O points on the PLC's expansion bus. The 8 I/O points can be allocated from either inputs or outputs.

1.1 External Dimensions

Mass: Approx. 0.2kg (0.44lbs) Dimensions: mm (inches)

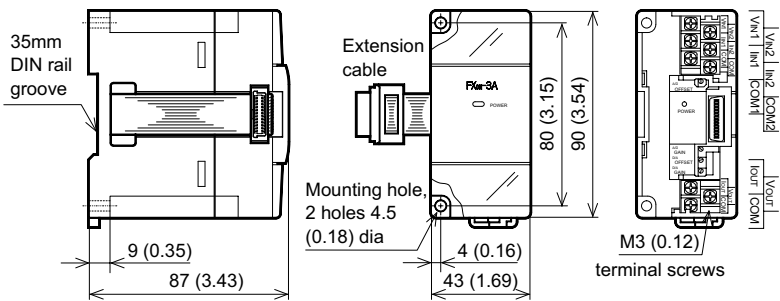

2. Terminal layouts and wiring

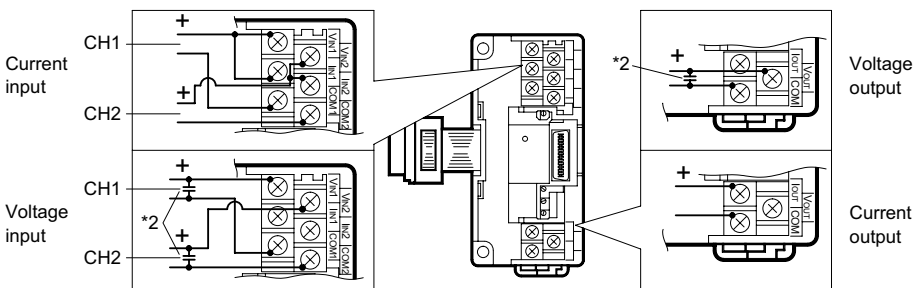

- When a current input is used, ensure that the terminals marked [VIN*1] and [IIN*1] are linked. Do not connect the [VOUT] and [IOUT] terminals when the current output is used. *1 terminal number 1 or 2 is identified here.
- If any voltage ripple is experienced on the voltage inputs/outputs or if there is excessive electrical noise, connect a capacitor of 0.1 to 0.47 μ F, approx. 25V rating at position *2.

3. Connection with PLC

1) Up to 4 FX0N-3A units can connect to the FX0N series PLC, up to 5 for FX1N, up to 8 for FX2N or, up to 4 for an FX2NC series PLC, all with powered extension units.

However the following limitation exists when the undermentioned special function blocks are connected.

FX2N: Main unit and powered extension units of 32 I/O points or less. Consumption current available for undermentioned special function blocks $\leq 190\text{mA}$

FX2N: Main unit and powered extension units of 48 I/O points or more. Consumption current available for undermentioned special function blocks $\leq 300\text{mA}$

FX2NC: Up to 4 undermentioned special function blocks can be connected regardless of the system I/O.

FX0N/1N: Main unit and powered extension units. Up to 2 undermentioned special function blocks can be connected regardless of the system I/O.

	FX2N-2AD	FX2N-2DA	FX0N-3A
Consumption current of 24V DC for one unit.	50mA	85mA	90mA

The consumption current of the above units is to be subtracted from the service power supply of the host PLC.

2) FX0N-3A consumes 5V DC by 30mA. The total 5V consumption of all special function blocks connected to either the FX2N or FX2NC main unit or an FX2N extension unit must not exceed the 5V voltage source capacity of the system.

3) The FX0N-3A and main unit are connected by a cable on the right of the main unit.

4. Installation notes and Usage

4.1 General and Environmental Specifications

Item	Specification
General specifications (ex. withstand voltage)	Same as those for the main unit
Withstand Voltage	500V AC for 1 minute (between ground and all other terminals)
Analog circuit power requirement	24V DC +/- 10%, 90mA (internal power supply from main unit)
Digital circuit power requirement	5V DC, 30mA (internal power supply from main unit)
Isolation	Photo-coupler isolation between analog and digital circuit. No isolation between analog channels.
Number of occupied I/O points	8 I/O points from expansion bus. (either input or output)

4.2 Performance Specifications

	Voltage input	Current input
Analog input range	At shipment, 0 to 250 range selected for 0 to 10V DC input. When using an FX0N-3A for current input or differing voltage inputs except 0 to 10V DC, it is necessary to readjust the offset and gain. The module does not allow different input characteristics for two channels.	
	0 to 10V, 0 to 5V DC, resistance 200k Ω . Warning: this unit may be damaged by input voltages in excess of -0.5V, +15V.	4 to 20mA, resistance 250 Ω . Warning: this unit may be damaged by input currents in excess of -2mA, +60mA.
Digital resolution	8 bits	
Smallest input signal resolution	40mV: 0 to 10V/0 to 250 (At shipment) Change depending on the input characteristic.	64 μA : 4 to 20mA /0 to 250 Change depending on the input characteristic.
Overall accuracy	$\pm 0.1\text{V}$	$\pm 0.16\text{mA}$
Processing time	TO instruction processing time x 2 + FROM instruction processing time	
Input characteristics	<p>[At shipment]</p> <p>The module does not allow different input characteristics for two channels.</p>	

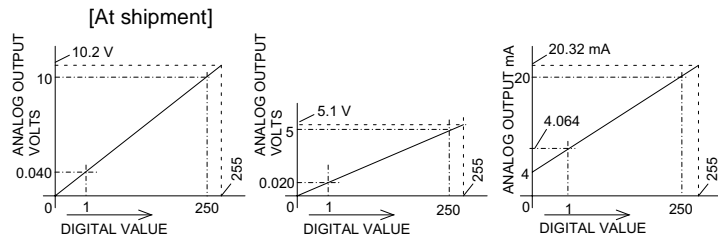
	Voltage output	Current output
Analog output range	At shipment, 0 to 250 range selected for 0 to 10V DC output. When using an FX _{0N} -3A for current output or differing voltage output except 0 to 10V DC, it is necessary to readjust the offset and gain.	
	DC 0 to 10V, 0 to 5V external load: 1kΩ to 1MΩ	4 to 20mA, external load: 500Ω or less
Digital resolution	8 bits	
Smallest output signal resolution	40mV: 0 to 10V/0 to 250(At shipment) Change depending on the input characteristic.	64μA: 4 to 20mA /0 to 250 Change depending on the input characteristic.
Overall accuracy	± 0.1V	± 0.16mA
Processing time	TO instruction processing time x 3	
Output characteristics	<p>[At shipment]</p> 	
	If digital source data of greater than 8 bits is used, only the lower 8 bits will be valid. Additional (upper) bits will be ignored	

5. Allocation of Buffer Memories (BFM)

When FNC176(RD3A) and FNC177(WR3A) are used with FX_{1N},FX_{2N} (V3.00 or more) or FX_{2NC} (V3.00 or more), the allocation of the buffer memory (BFM) need not be considered.

BFM No.	b15-b8	b7	b6	b5	b4	b3	b2	b1	b0
0	Reserved	Current value input data (stored in 8 bits) of the A/D channel selected by b0 of BFM#17							
16		Current value output data on D/A channel (stored in 8 bits)							
17	Reserved						D/A start	A/D start	A/D channel
1-5, 18-31	Reserved								

- BFM 17:
 - b0 = 0 analog input channel 1 is selected
 - b0 = 1 analog input channel 2 is selected
 - b1 = 0 ⇒ 1, the A/D conversion process is started
 - b2 = 1 ⇒ 0, the D/A conversion process is started
- Note: These buffer memory devices are stored/located within the FX_{0N}-3A

6. Diagnostics

6.1 Preliminary Checks

- Check whether the input/output wiring and/or expansion cables are properly connected.
- Check that the system configuration rules for the host PLC have not been broken.
- Ensure that the correct operating range has been selected for the application.
- As the status of the PLC changes (RUN ⇒ STOP, STOP ⇒ RUN, etc.), the analog output status will operate in the following manner.

Status change of the host PLC:

- RUN ⇒ STOP: The last operational value used by the analog output channel during RUN operation is retained during STOP mode.
 - STOP ⇒ RUN: Once the host PLC is switched back into RUN mode the analog output reacts as normal to the program controlled, digital values.
- PLC power shutdown: The analog output signal ceases operation.
- Remember that only 8 bit digital values (0 to 255) are valid for use with the analog output of the FX_{0N}-3A

7. Change and adjustment method of input/output characteristic

7.1 Change in input/output characteristic

At shipment, 0 to 250 range selected for 0 to 10V DC input/output.

When using an FX0N-3A for current input/output or differing voltage input/output except 0 to 10V DC, it is necessary to readjust the offset and gain.

The module does not allow different input characteristics for two channels.

Set analog values from 0 to 250 digital equivalent within the range specified in the table below when changing the input/output characteristic.

Range of allowance of input/output characteristic

	Voltage input	Current input	Voltage output	Current output
Analog value when digital value is 0	0 to 1V	0 to 4mA	0V	4mA
Analog value when digital value is 250	5 to 10V	20mA	5 to 10V	20mA

Resolution changes depending on the set value when the input/output characteristic is changed.

Example: Resolution becomes $(5 \text{ to } 0V)/250=20mV$ at voltage input 0 to 5V/0 to 250.

Overall accuracy does not change. (Voltage input: $\pm 0.1V$, Current input: $\pm 0.16mA$)

7.2 Method of Calibration(A/D)

Both analog input channels share the same 'setup' and configuration. Hence only one channel needs to be selected to perform the calibration for both analog input channels.

Use the following program and the appropriate wiring configuration to calibrate input channel 1 (and indirectly channel 2) of the FX0N-3A.

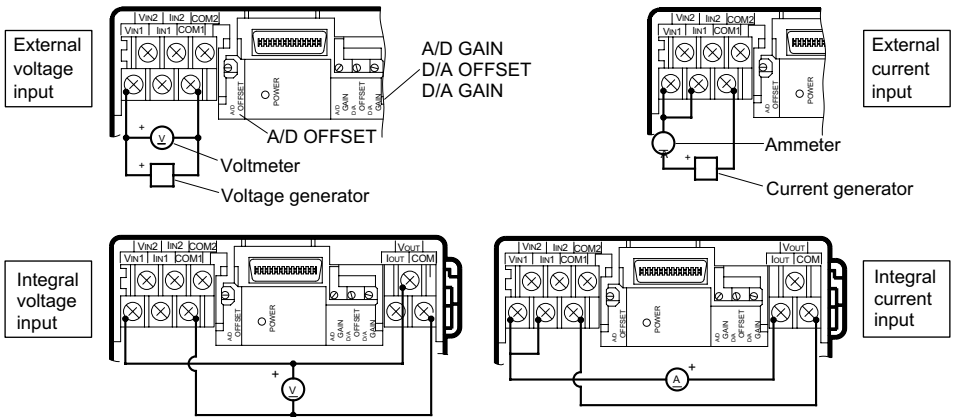

7.2.1 Input Calibration Program

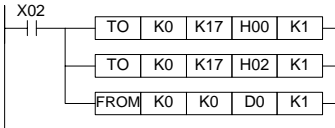

7.2.2 Calibrating the Offset

- 1) Run the previously detailed program. Ensure X02 is ON.
- 2) Generate an offset voltage/current (in accordance with the analog operation range to be selected, see table below) using the selected generator or analog output.
- 3) Adjust the A/D OFFSET potentiometer ('pot') until a digital value of 1 is read in D00.
Note : Turn the 'pot' clockwise and the digital value will increase. The 'pot' requires 18 revolutions to move between the minimum and maximum settings.

Analog input range	0-10V DC	0-5V DC	4-20mA DC
Offset calibration value	0.040V	0.020V	4.064mA

7.2.3 Calibrating the Gain

- 1) Run the previously detailed program. Ensure X02 is ON.
- 2) Generate a gain voltage/current (in accordance with the analog operation range to be selected, see table below) using the selected generator or analog output.
- 3) Adjust the A/D GAIN potentiometer ('pot') until a digital value of 250 is read in D00.

Note 1: Turn the 'pot' clockwise and the digital value will increase. The 'pot' requires 18 revolutions to move between the minimum and maximum settings.

Note 2: When necessary to maximize the 8 bit resolution, the digital value used in the gain adjustment (detailed above) should be replaced with 255. This section has been written to demonstrate 250 full scale calibration.

Analog input range	0-10V DC	0-5V DC	4-20mA DC
Gain calibration value	10.000V	5.000V	20.000mA

7.3 Method of Calibration(D/A)

Use the following program and the appropriate wiring configuration to calibrate the output channel of the FX0N-3A

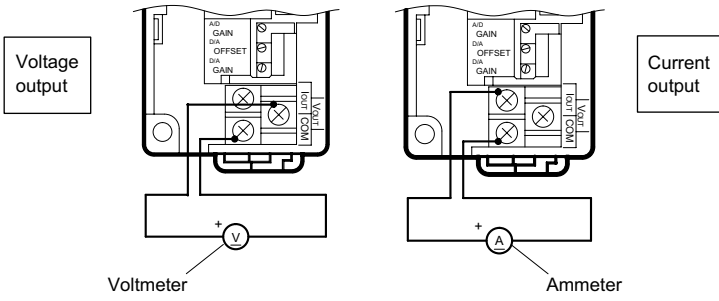

7.3.1 Output Calibration Program

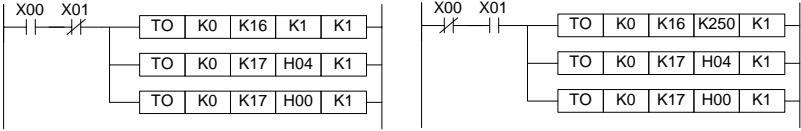

7.3.2 Calibrating the Offset

- 1) Run the previously detailed program. Ensure X00 is ON and X01 is OFF.
- 2) Adjust the D/A OFFSET potentiometer ('pot') until the selected meter displays the appropriate offset voltage/current (in accordance with the analog operation range selected, see table below).

Note: Turn the 'pot' clockwise and the analog output signal will increase. The 'pot' requires 18 revolutions to move between the minimum and maximum settings.

Analog output range	0-10V DC	0-5V DC	4-20mA DC
Offset calibration meter value	0.040V	0.020V	4.064mA

7.3.3 Calibrating the Gain

- 1) Run the previously detailed program. Ensure X00 is OFF and X01 is ON.
- 2) Adjust the D/A GAIN potentiometer ('pot') until selected meter displays the appropriate gain voltage/current (in accordance with the analog operation range selected, see table below).

Note 1: Turn the 'pot' clockwise and the analog output signal will increase. The 'pot' requires 18 revolutions to move between the minimum and maximum settings

Note 2: When it is necessary to maximize the 8 bit resolution, the digital value used in the gain adjustment (detailed above) should be replaced with 255. This section has been written to demonstrate a 250 full scale calibration.

Analog output range	0-10V DC	0-5V DC	4-20mA DC
Gain calibration meter value	10.000V	5.000V	20.000mA

8. Program example

8.1 Using Analog Inputs

The buffer memories (BFM) of the FX0N-3A are written TO or read FROM by the host PLC. The following program reads the analog input from channel 1 of the FX0N-3A when M0 is ON, and the analog input data of channel 2 when M1 is ON.

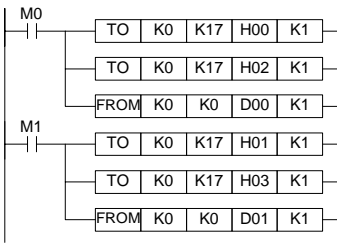

(H00) is written to BFM#17, selecting A/D input channel 1.
 (H02) is written to BFM#17 starting the A/D conversion process for channel 1.
 BFM#0 is read, storing the current value of channel 1 in register D00
 (H01) is written to BFM#17 now selecting A/D input channel 2.
 (H03) is written to BFM#17 to re-start the A/D conversion process, but for channel 2.
 BFM#0 is read, storing the current value of channel 2 in register D01.

The time TAD required to read an analog input channel is calculated as follows:

$$TAD = (\text{TO instruction processing time}) \times 2 + (\text{FROM instruction processing time})$$

Note : The 3 (TO/FROM) command format shown above should always be used when reading data from the FX0N-3A's analog input channels.

8.2 Using Analog Outputs

The buffer memories (BFM) of the FX0N-3A are written TO, or read FROM by the host PLC. In the following program, when M0 is turned ON the D/A conversion process is executed and an analog signal equivalent to the digital value stored in this example, is output to register D02

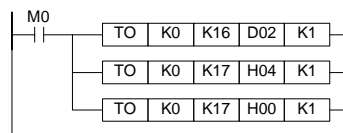

The contents of D2 are written to BFM#16. This will be converted to an analog output.
(H04) is written to BFM#17 to start the D/A conversion process.

The time TAD required to write an analog input channel is calculated as follows:

$$TAD = (\text{TO instruction processing time}) \times 3$$

Note : The 3 (TO) instruction format shown above should always be used when writing data to the FX0N-3A's analog output channel.

Details on both the FROM and TO instructions (functions 78 and 79 respectively) can be found in the "FX series Programming Manual (II)"

8.3 Using FX1N, FX2N (V3.00 or more) or FX2NC (V3.00 or more) Series PLC's

Please use FNC 176 (RD3A) and FNC 177 (WR3A)

Refer to FX Series Programming Manual II.

9. Error Checking

If the FX0N-3A special function block does not seem to operate normally, check the following items:

- Check the status of POWER LED.
Lit: The extension cable is properly connected.
Otherwise: Check the connection of the extension cable.
- Check the external wiring.
- Check whether the output load connected to the analog output terminal is within the following specified limits.
Voltage output: 1kΩ to 1MΩ, Current output: 500Ω or less
- Check whether the impedance of the input device is within the specified limits.
Voltage input: 200kΩ, Current input: 250Ω.
- Check the calibration of the FX0N-3A's analog channels (input and output) using a voltmeter/ ammeter as required. See previous two sections for a detailed explanation.

Guidelines for the safety of the user and protection of the FX0N-3A Special function block

- This manual has been written to be used by trained and competent personnel. This is defined by the European directives for machinery and EMC.
- If in doubt at any stage during the installation of the FX0N-3A always consult a professional electrical engineer who is qualified and trained to the local and national standards. If in doubt about the operation or use of the FX0N-3A please consult the nearest Mitsubishi Electric distributor.
- Under no circumstances will Mitsubishi Electric be liable or responsible for any consequential damage that may arise as a result of the installation or use of this equipment.
- All examples and diagrams shown in this manual are intended only as an aid to understanding the text, not to guarantee operation. Mitsubishi Electric will accept no responsibility for actual use of the product based on these illustrative examples.
- Owing to the very great variety in possible application of this equipment, you must satisfy yourself as to its suitability for your specific application.

Manual number : JY992D49001

Manual revision : E

Date : SEPTEMBER 2002

 **MITSUBISHI ELECTRIC CORPORATION**

HEAD OFFICE : MITSUBISHI DENKI BLDG MARUNOUTI TOKYO 100-8310 TELEX : J24532 CABLE MELCO TOKYO
HIMEJI WORKS : 840, CHIYODA CHO, HIMEJI, JAPAN

FX0N

FX0N-3A SPECIAL FUNCTION BLOCK

USER'S GUIDE

JY992D49001E

This manual contains text, diagrams and explanations which will guide the user in the correct installation and operation of the FX0N-3A special function block and should be read and understood before attempting to install or use the unit. Further information can be found in the FX PROGRAMMING MANUAL(II), FX0N /FX1N/FX2N/FX2NC SERIES HARDWARE MANUAL.

1. Introduction

- The FX0N-3A analog special function block has two input channels and one output channel. The input channels receive analog signals and convert them into digital values. The output channel takes a digital value and outputs an equivalent analog signal. The FX0N-3A has a maximum resolution of 8 bits.
- The selection of voltage or current based input/output is decided by user wiring.
- An FX0N-3A can be connected to the FX2N, FX2NC, FX1N or FX0N series of Programmable Controllers (Hereafter referred to as a PLC).
- All data transfers and parameter setups are adjusted through software control for the FX0N-3A, via TO/FROM applied instructions in the PLC. Communications between the PLC and FX0N-3A are protected by a photo-coupler.
- An FX0N-3A occupies 8 I/O points on the PLC's expansion bus. The 8 I/O points can be allocated from either inputs or outputs.

1.1 External Dimensions

Mass: Approx. 0.2kg (0.44lbs) Dimensions: mm (inches)

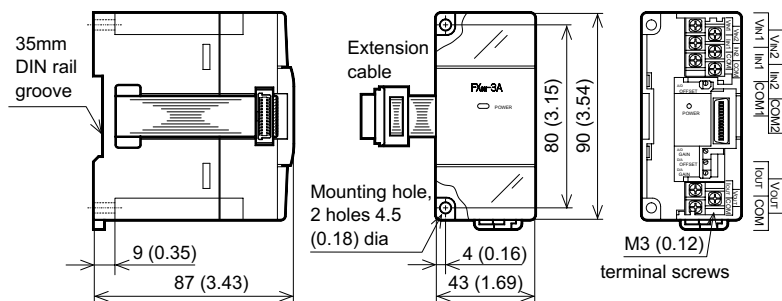

2. Terminal layouts and wiring

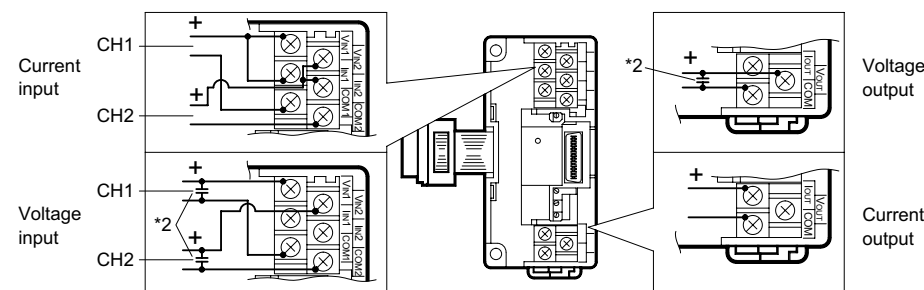

- When a current input is used, ensure that the terminals marked [VIN*1] and [IIN*1] are linked. Do not connect the [VOUT] and [IOUT] terminals when the current output is used. *1 terminal number 1 or 2 is identified here.
- If any voltage ripple is experienced on the voltage inputs/outputs or if there is excessive electrical noise, connect a capacitor of 0.1 to 0.47μF, approx. 25V rating at position *2.

3. Connection with PLC

- Up to 4 FX0N-3A units can connect to the FX0N series PLC, up to 5 for FX1N, up to 8 for FX2N or, up to 4 for an FX2NC series PLC, all with powered extension units. However the following limitation exists when the undermentioned special function blocks are connected.
 - FX2N: Main unit and powered extension units of 32 I/O points or less. Consumption current available for undermentioned special function blocks ≤ 190mA
 - FX2N: Main unit and powered extension units of 48 I/O points or more. Consumption current available for undermentioned special function blocks ≤ 300mA
 - FX2NC: Up to 4 undermentioned special function blocks can be connected regardless of the system I/O.
 - FX0N/1N: Main unit and powered extension units. Up to 2 undermentioned special function blocks can be connected regardless of the system I/O.

	FX2N-2AD	FX2N-2DA	FX0N-3A
Consumption current of 24V DC for one unit.	50mA	85mA	90mA

The consumption current of the above units is to be subtracted from the service power supply of the host PLC.

- FX0N-3A consumes 5V DC by 30mA. The total 5V consumption of all special function blocks connected to either the FX2N or FX2NC main unit or an FX2N extension unit must not exceed the 5V voltage source capacity of the system.
- The FX0N-3A and main unit are connected by a cable on the right of the main unit.

4. Installation notes and Usage

4.1 General and Environmental Specifications

Item	Specification
General specifications (ex. withstand voltage)	Same as those for the main unit
Withstand Voltage	500V AC for 1 minute (between ground and all other terminals)
Analog circuit power requirement	24V DC +/- 10%, 90mA (internal power supply from main unit)
Digital circuit power requirement	5V DC, 30mA (internal power supply from main unit)
Isolation	Photo-coupler isolation between analog and digital circuit. No isolation between analog channels.
Number of occupied I/O points	8 I/O points from expansion bus. (either input or output)

4.2 Performance Specifications

	Voltage input	Current input
Analog input range	At shipment, 0 to 250 range selected for 0 to 10V DC input. When using an FX0N-3A for current input or differing voltage inputs except 0 to 10V DC, it is necessary to readjust the offset and gain. The module does not allow different input characteristics for two channels.	At shipment, 0 to 250 range selected for 0 to 10V DC input. When using an FX0N-3A for current input or differing voltage inputs except 0 to 10V DC, it is necessary to readjust the offset and gain. The module does not allow different input characteristics for two channels.
Digital resolution	8 bits	
Smallest input signal resolution	40mV: 0 to 10V/0 to 250(At shipment) Change depending on the input characteristic.	64μA: 4 to 20mA /0 to 250 Change depending on the input characteristic.
Overall accuracy	± 0.1V	
Processing time	TO instruction processing time x 2 + FROM instruction processing time	
Input characteristics		
	The module does not allow different input characteristics for two channels.	

	Voltage output	Current output
Analog output range	At shipment, 0 to 250 range selected for 0 to 10V DC output. When using an FX0N-3A for current output or differing voltage output except 0 to 10V DC, it is necessary to readjust the offset and gain.	At shipment, 0 to 250 range selected for 0 to 10V DC output. When using an FX0N-3A for current output or differing voltage output except 0 to 10V DC, it is necessary to readjust the offset and gain.
Digital resolution	8 bits	
Smallest output signal resolution	40mV: 0 to 10V/0 to 250(At shipment) Change depending on the input characteristic.	64μA: 4 to 20mA /0 to 250 Change depending on the input characteristic.
Overall accuracy	± 0.1V	
Processing time	TO instruction processing time x 3	
Output characteristics		
	If digital source data of greater than 8 bits is used, only the lower 8 bits will be valid. Additional (upper) bits will be ignored	

5. Allocation of Buffer Memories (BFM)

When FNC176(RD3A) and FNC177(WR3A) are used with FX1N,FX2N (V3.00 or more) or FX2NC (V3.00 or more), the allocation of the buffer memory (BFM) need not be considered.

BFM No.	b15-b8	b7	b6	b5	b4	b3	b2	b1	b0
0	Reserved	Current value input data (stored in 8 bits) of the A/D channel selected by b0 of BFM#17							
16		Current value output data on D/A channel (stored in 8 bits)							
17	Reserved						D/A start	A/D start	A/D channel
1-5, 18-31	Reserved								

- BFM 17:
 - b0 = 0 analog input channel 1 is selected
 - b0 = 1 analog input channel 2 is selected
 - b1 = 0 ⇒ 1, the A/D conversion process is started
 - b2 = 1 ⇒ 0, the D/A conversion process is started
- Note: These buffer memory devices are stored/located within the FX0N-3A

6. Diagnostics

6.1 Preliminary Checks

- Check whether the input/output wiring and/or expansion cables are properly connected.
- Check that the system configuration rules for the host PLC have not been broken.
- Ensure that the correct operating range has been selected for the application.
- As the status of the PLC changes (RUN ⇒ STOP, STOP ⇒ RUN, etc.), the analog output status will operate in the following manner.
 - Status change of the host PLC:**
 - RUN ⇒ STOP: The last operational value used by the analog output channel during RUN operation is retained during STOP mode.
 - STOP ⇒ RUN: Once the host PLC is switched back into RUN mode the analog output reacts as normal to the program controlled, digital values. PLC power shutdown: The analog output signal ceases operation.
- Remember that only 8 bit digital values (0 to 255) are valid for use with the analog output of the FX0N-3A

7. Change and adjustment method of input/output characteristic

7.1 Change in input/output characteristic

At shipment, 0 to 250 range selected for 0 to 10V DC input/output.

When using an FX0N-3A for current input/output or differing voltage input/output except 0 to 10V DC, it is necessary to readjust the offset and gain.

The module does not allow different input characteristics for two channels.

Set analog values from 0 to 250 digital equivalent within the range specified in the table below when changing the input/output characteristic.

Range of allowance of input/output characteristic

	Voltage input	Current input	Voltage output	Current output
Analog value when digital value is 0	0 to 1V	0 to 4mA	0V	4mA
Analog value when digital value is 250	5 to 10V	20mA	5 to 10V	20mA

Resolution changes depending on the set value when the input/output characteristic is changed.

Example: Resolution becomes (5 to 0V)/250=20mV at voltage input 0 to 5V/0 to 250.

Overall accuracy does not change. (Voltage input: ±0.1V, Current input: ±0.16mA)

7.2 Method of Calibration(A/D)

Both analog input channels share the same 'setup' and configuration. Hence only one channel needs to be selected to perform the calibration for both analog input channels.

Use the following program and the appropriate wiring configuration to calibrate input channel 1 (and indirectly channel 2) of the FX0N-3A.

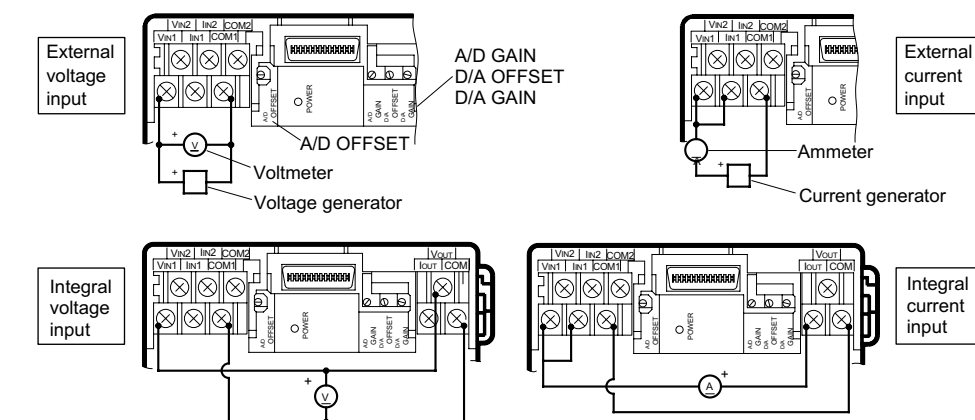

7.2.1 Input Calibration Program

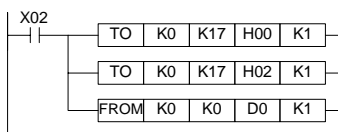

7.2.2 Calibrating the Offset

- Run the previously detailed program. Ensure X02 is ON.
- Generate an offset voltage/current (in accordance with the analog operation range to be selected, see table below) using the selected generator or analog output.
- Adjust the A/D OFFSET potentiometer ('pot') until a digital value of 1 is read in D00.
Note : Turn the 'pot' clockwise and the digital value will increase. The 'pot' requires 18 revolutions to move between the minimum and maximum settings.

Analog input range	0-10V DC	0-5V DC	4-20mA DC
Offset calibration value	0.040V	0.020V	4.064mA

7.2.3 Calibrating the Gain

- Run the previously detailed program. Ensure X02 is ON.
- Generate a gain voltage/current (in accordance with the analog operation range to be selected, see table below) using the selected generator or analog output.
- Adjust the A/D GAIN potentiometer ('pot') until a digital value of 250 is read in D00.

Note 1: Turn the 'pot' clockwise and the digital value will increase. The 'pot' requires 18 revolutions to move between the minimum and maximum settings.

Note 2: When necessary to maximize the 8 bit resolution, the digital value used in the gain adjustment (detailed above) should be replaced with 255. This section has been written to demonstrate 250 full scale calibration.

Analog input range	0-10V DC	0-5V DC	4-20mA DC
Gain calibration value	10.000V	5.000V	20.000mA

7.3 Method of Calibration(D/A)

Use the following program and the appropriate wiring configuration to calibrate the output channel of the FX0N-3A

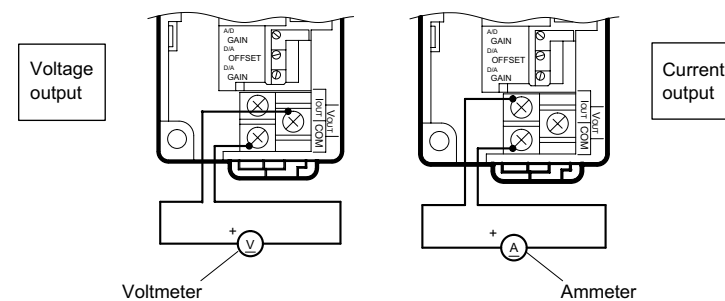

7.3.1 Output Calibration Program

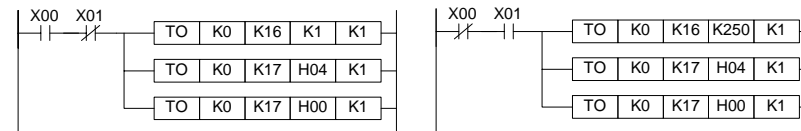

7.3.2 Calibrating the Offset

- Run the previously detailed program. Ensure X00 is ON and X01 is OFF.
- Adjust the D/A OFFSET potentiometer ('pot') until the selected meter displays the appropriate offset voltage/current (in accordance with the analog operation range selected, see table below).

Note: Turn the 'pot' clockwise and the analog output signal will increase. The 'pot' requires 18 revolutions to move between the minimum and maximum settings.

Analog output range	0-10V DC	0-5V DC	4-20mA DC
Offset calibration meter value	0.040V	0.020V	4.064mA

7.3.3 Calibrating the Gain

- Run the previously detailed program. Ensure X00 is OFF and X01 is ON.
- Adjust the D/A GAIN potentiometer ('pot') until selected meter displays the appropriate gain voltage/current (in accordance with the analog operation range selected, see table below).

Note 1: Turn the 'pot' clockwise and the analog output signal will increase. The 'pot' requires 18 revolutions to move between the minimum and maximum settings

Note 2: When it is necessary to maximize the 8 bit resolution, the digital value used in the gain adjustment (detailed above) should be replaced with 255. This section has been written to demonstrate a 250 full scale calibration.

Analog output range	0-10V DC	0-5V DC	4-20mA DC
Gain calibration meter value	10.000V	5.000V	20.000mA

8. Program example

8.1 Using Analog Inputs

The buffer memories (BFM) of the FX0N-3A are written TO or read FROM by the host PLC. The following program reads the analog input from channel 1 of the FX0N-3A when M0 is ON, and the analog input data of channel 2 when M1 is ON.

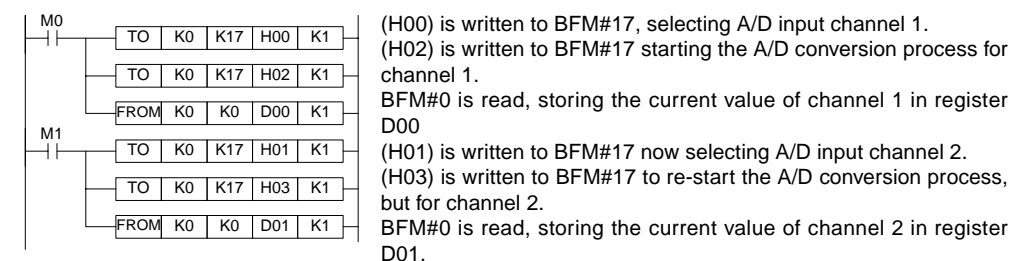

(H00) is written to BFM#17, selecting A/D input channel 1.
(H02) is written to BFM#17 starting the A/D conversion process for channel 1.
BFM#0 is read, storing the current value of channel 1 in register D00
(H01) is written to BFM#17 now selecting A/D input channel 2.
(H03) is written to BFM#17 to re-start the A/D conversion process, but for channel 2.
BFM#0 is read, storing the current value of channel 2 in register D01.

The time TAD required to read an analog input channel is calculated as follows:

$$TAD = (\text{TO instruction processing time}) \times 2 + (\text{FROM instruction processing time})$$

Note : The 3 (TO/FROM) command format shown above should always be used when reading data from the FX0N-3A's analog input channels.

8.2 Using Analog Outputs

The buffer memories (BFM) of the FX0N-3A are written TO, or read FROM by the host PLC. In the following program, when M0 is turned ON the D/A conversion process is executed and an analog signal equivalent to the digital value stored in this example, is output to register D02

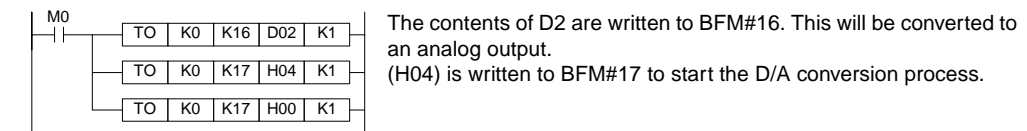

The contents of D2 are written to BFM#16. This will be converted to an analog output.
(H04) is written to BFM#17 to start the D/A conversion process.

The time TAD required to write an analog input channel is calculated as follows:

$$TAD = (\text{TO instruction processing time}) \times 3$$

Note : The 3 (TO) instruction format shown above should always be used when writing data to the FX0N-3A's analog output channel.

Details on both the FROM and TO instructions (functions 78 and 79 respectively) can be found in the "FX series Programming Manual (II)"

8.3 Using FX1N, FX2N (V3.00 or more) or FX2NC (V3.00 or more) Series PLC's

Please use FNC 176 (RD3A) and FNC 177 (WR3A)

Refer to FX Series Programming Manual II.

9. Error Checking

If the FX0N-3A special function block does not seem to operate normally, check the following items:

- Check the status of POWER LED.
Lit: The extension cable is properly connected.
Otherwise: Check the connection of the extension cable.
- Check the external wiring.
- Check whether the output load connected to the analog output terminal is within the following specified limits.
Voltage output: 1kΩ to 1MΩ, Current output: 500Ω or less
- Check whether the impedance of the input device is within the specified limits.
Voltage input: 200kΩ, Current input: 250Ω
- Check the calibration of the FX0N-3A's analog channels (input and output) using a voltmeter/ ammeter as required. See previous two sections for a detailed explanation.

Guidelines for the safety of the user and protection of the FX0N-3A Special function block

- This manual has been written to be used by trained and competent personnel. This is defined by the European directives for machinery and EMC.
- If in doubt at any stage during the installation of the FX0N-3A always consult a professional electrical engineer who is qualified and trained to the local and national standards. If in doubt about the operation or use of the FX0N-3A please consult the nearest Mitsubishi Electric distributor.
- Under no circumstances will Mitsubishi Electric be liable or responsible for any consequential damage that may arise as a result of the installation or use of this equipment.
- All examples and diagrams shown in this manual are intended only as an aid to understanding the text, not to guarantee operation. Mitsubishi Electric will accept no responsibility for actual use of the product based on these illustrative examples.
- Owing to the very great variety in possible application of this equipment, you must satisfy yourself as to its suitability for your specific application.

Manual number : JY992D49001

Manual revision : E

Date : SEPTEMBER 2002

MITSUBISHI ELECTRIC CORPORATION

HEAD OFFICE : MITSUBISHI DENKI BLDG MARUNOUCHI TOKYO 100-8310 TELEX : J24532 CABLE MELCO TOKYO
HIMEJI WORKS : 840, CHIYODA CHO, HIMEJI, JAPAN

JY992D49001E

Effective Sep. 2002
Specifications are subject to
change without notice