

MELSOFT

Programmable Logic Controllers

Operating Manual (Function Block)

GX Developer 7

• SAFETY PRECAUTIONS •

(Always read these instructions before using this equipment.)

Before using this product, please read this manual and the relevant manuals introduced in this manual carefully and pay full attention to safety to handle the product correctly.

The instructions given in this manual are concerned with this product. For the safety instructions of the programmable controller system, please read the CPU module user's manual.

In this manual, the safety instructions are ranked as "DANGER" and "CAUTION".



Indicates that incorrect handling may cause hazardous conditions, resulting in death or severe injury.



Indicates that incorrect handling may cause hazardous conditions, resulting in medium or slight personal injury or physical damage.

Note that the  CAUTION level may lead to a serious consequence according to the circumstances. Always follow the instructions of both levels because they are important to personal safety.

Please save this manual to make it accessible when required and always forward it to the end user.

[Design Instructions]

DANGER

- For data change, program change, and status control made to the PLC which is running from a Personal computer, configure the interlock circuit externally so that the system safety is ensured. The action to be taken for the system at the occurrence of communication errors caused by such as loose cable connection must be determined for online operation of PLC from Personal computers.

CAUTION

- Before connecting a Personal computer to a CPU module in the RUN status and carrying out online operation (particularly program changes, forced output, and changing the operating status), read the manual carefully and confirm safety. Failure to do this could result in damage to the machine and accidents due to misoperation.

REVISIONS

* The manual number is given on the bottom left of the back cover.

Print Date	* Manual Number	Revision
Jun, 2001	IB (NA) 0800195-A	First editions

Japanese Manual Version SH-080173-A

This manual confers no industrial property rights or any rights of any other kind, nor does it confer any patent licenses. Mitsubishi Electric Corporation cannot be held responsible for any problems involving industrial property rights which may occur as a result of using the contents noted in this manual.

© 2001 MITSUBISHI ELECTRIC CORPORATION

INTRODUCTION

Thank you for choosing the Mitsubishi MELSOFT series Integrated FA software.
Read this manual and make sure you understand the functions and performance of MELSEC series sequencer thoroughly in advance to ensure correct use.
Please make this manual available to the end user.

CONTENTS

Safety Introductions.....	A- 1
Revisions	A- 2
Contents	A- 3
About Manuals	A- 5
About the Generic Terms and Abbreviations	A- 6

1 OVERVIEW	1- 1 to 1- 7
-------------------	---------------------

1.1 What Is Function Block (FB)?	1- 1
1.2 Features	1- 2
1.3 Layouts and Names of Windows for Creating FB.....	1- 2
1.4 What You Should Understand Before Using the FB.....	1- 4
1.5 Specifications	1- 5
1.5.1 Compatible CPUs.....	1- 5
1.5.2 Specifications of and precautions for the FB.....	1- 5

2 GENERAL PROCEDURES FOR EDITING THE FB	2- 1 to 2- 2
--	---------------------

3 CREATING NEW SEQUENCE PROGRAM USING FB	3- 1 to 3-39
---	---------------------

3.1 Crating New Project for FB.....	3- 1
3.2 Adding New FB Definition to the Created Project.....	3- 5
3.3 Creating FB Definition Program.....	3- 7
3.4 Creating FB Variables.....	3-11
3.5 Converting the FB Definition (Compile).....	3-14
3.6 Pasting the Converted FB to Sequence Program (FB Utilization)	3-16
3.6.1 Pasting the FB definition to sequence program	3-16
3.6.2 Changing the name (FB name) of the pasted FB (FB name changing)	3-19
3.7 Creating the Sequence Program.....	3-21
3.7.1 Editing the sequence program.....	3-21
3.7.2 Confirming the data of the pasted FB.....	3-24
3.7.3 Searching/replacing the sequence program (Search/replace)	3-26
3.7.4 Creating/displaying the comments, statements or notes (Sentence creation)	3-28
3.8 Converting the Sequence Program into Program to Be Executed on the PLC CPU (Compile)	3-29
3.9 Writing the Converted Sequence Program to the PLC CPU (Write to PLC)	3-32
3.10 Monitoring and Testing the Sequence Program	3-33
3.10.1 Monitoring the sequence program.....	3-33
3.10.2 Testing the sequence program (Device test)	3-36
3.11 Correcting the FB.....	3-38
3.12 Making Online Program Correction to the Sequence Program.....	3-39

4 UTILIZING THE EXISTING FB TO CREATE SEQUENCE PROGRAM	4- 1 to 4- 9
--	--------------

4.1 Creating Project for FB	4- 1
4.1.1 Creating a new project	4- 1
4.1.2 Reading the existing project.....	4- 1
4.2 Utilizing the Existing FB Definition (Copy).....	4- 2
4.2.1 Utilizing the existing FB definition from another project	4- 2
4.2.2 Utilizing the existing FB definition within the same project	4- 4
4.3 Changing the FB Definition Name.....	4- 6
4.4 Correcting the Program Body or FB Variables of the Utilized FB Definition	4- 8
4.5 Converting the FB Definition (Compile).....	4- 9
4.6 Pasting the Converted FB to the Sequence Program (FB Utilization)	4- 9
4.7 Creating the Sequence Program.....	4- 9
4.8 Converting the Sequence Program into the Program to Be Executed on the PLC CPU (Compile).....	4- 9
4.9 Writing the Converted Sequence Program to the PLC CPU (Write to PLC)	4- 9

5 DELETING UNNECESSARY FB DEFINITION FROM THE PROJECT	5- 1 to 5- 2
---	--------------

6 COMBINING MULTIPLE PROGRAMS INTO ONE	6- 1 to 6- 2
--	--------------

6.1 Combining Sequence Programs into One	6- 1
6.2 Combining Comments into One (Data Joint)	6- 2

7 VERIFYING THE PROJECTS	7- 1 to 7- 2
--------------------------	--------------

8 PRINTING	8- 1 to 8- 4
------------	--------------

8.1 Printing the Sequence Program Including FB.....	8- 1
8.2 Printing the FB Definition	8- 3

APPENDICES	Appendix- 1 to Appendix - 2
------------	-----------------------------

Appendix 1 Character Strings Unusable as Labels and FB Names	Appendix- 1
--	-------------

INDEX	Index - 1 to Index - 2
-------	------------------------

About Manuals

The following manuals are also related to this product.

In necessary, order them by quoting the details in the tables below.

Related Manuals

Manual Name	Manual Number
GX Developer Version 7 Operating Manual (Startup) Describes the system configuration, installation method and starting method of GX Developer. (Option)	IB-0800189
GX Developer Version 7 Operating Manual Explains the functions of the programming, printout, monitoring and debugging methods and so on GX Developer. (Option)	IB-0800195

REMARK

The above manuals are contained in the CD-ROM together with the software package as a set.

If you want the manuals separately, they are available optionally as printed matter. When placing an order, please indicate the manual numbers (type codes) given in the above table.

About the Generic Terms and Abbreviations

This manual uses the following generic names and abbreviations to represent the GX Developer software package and PLC CPU modules. The module type is given when the corresponding type must be indicated clearly.

Generic Term/Abbreviation	Description
GX Developer	Generic product name of product types SWnD5C-GPPW, SWnD5C-GPPW-A, SWnD5C-GPPW-V and SWnD5C-GPPW-VA. (n indicates Version 7 or later.)
FB	Abbreviation of the function block.
QnACPU	Generic name of the MELSEC-QnA series PLC CPUs.
QCPU (Q mode)	Generic name of the Q00(J)CPU, Q01CPU, Q02(H)CPU, Q06HCPU, Q12HCPU and Q25HCPU.
ACPU	Generic name of the MELSEC-A series PLC CPUs. It includes the QCPUs (A mode) and motion controllers (SCPU).
QCPU (A mode)	Generic name of the Q02(H)CPU-A and Q06HCPU-A.
FXCPU	Generic name of the MELSEC-FX series PLC CPUs. (The target PLCs are the FX0, FX0s, FX0N, FX1, FX2, FX2c, FX1s, FX1N, FX2N and FX2NC.)
QnA series	When GX Developer is started on the QnACPU.
Q series	When GX Developer is started on the QCPU (Q mode).

1 OVERVIEW

This manual describes the operations of editing the function block (hereafter abbreviated to the FB) of the GX Developer Version 7 software package (hereafter abbreviated to GX Developer).

For the explanation of the functions other than the FB, refer to the corresponding manuals given in the "Related Manuals".

1.1 What Is Function Block (FB)?

The FB is a function designed to convert a ladder block, which is used in a sequence program repeatedly, into a component (FB) to utilize it in the sequence program. This not only increases the efficiency of program development but also reduces programming mistakes to improve program quality.

Definition of FB

Definition of FB definition program and FB variables

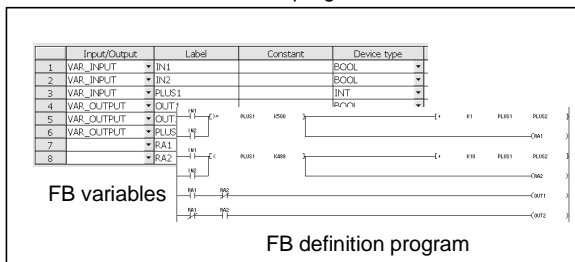

FB

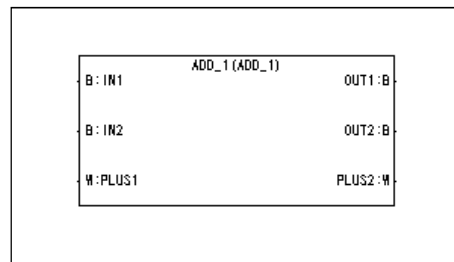

Utilization of FB

Pasting of FB to sequence program

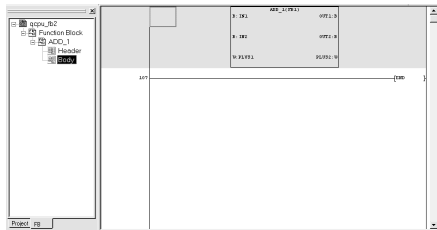

Creation of sequence program

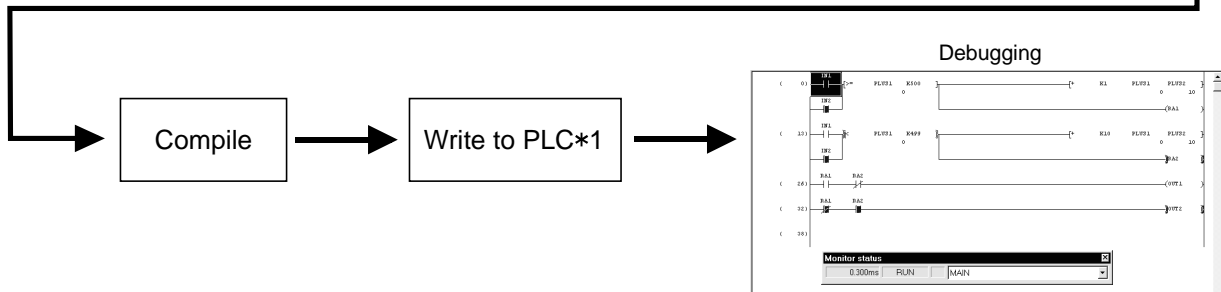
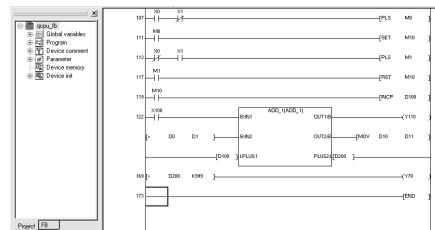

*1: GX Developer performs write to PLC to write the compiled sequence program to the PLC CPU. Hence, the FB cannot be displayed if read from PLC is performed to read the sequence program from the PLC CPU. Carefully store the sequence program that is not yet compiled since it is needed to correct the FB.

1.2 Features

1

The FB has the following features.

(1) Conversion of program into component

Displaying a standard program as a single block improves the reuse and readability of the program, facilitating editing and debugging. This ensures ease of configuring a large-scale program.

(2) Uniform program quality

Reusing the components of a standard program provides uniform program quality, which is independent of the technological level of a program developer. It also prevents programming mistakes during utilization.

(3) Editing function of high operability

The FB can be utilized easily in a sequence program by drag and drop operation.

1.3 Layouts and Names of Windows for Creating FB

This section describes the layouts and names of the windows used to create the FB.

(1) Window used to create FB definition program (FB definition window)

This window is used to edit an FB definition program, which is created in a ladder or list format.

Labels define variable types, device types and others on the FB variable setting window in (2).

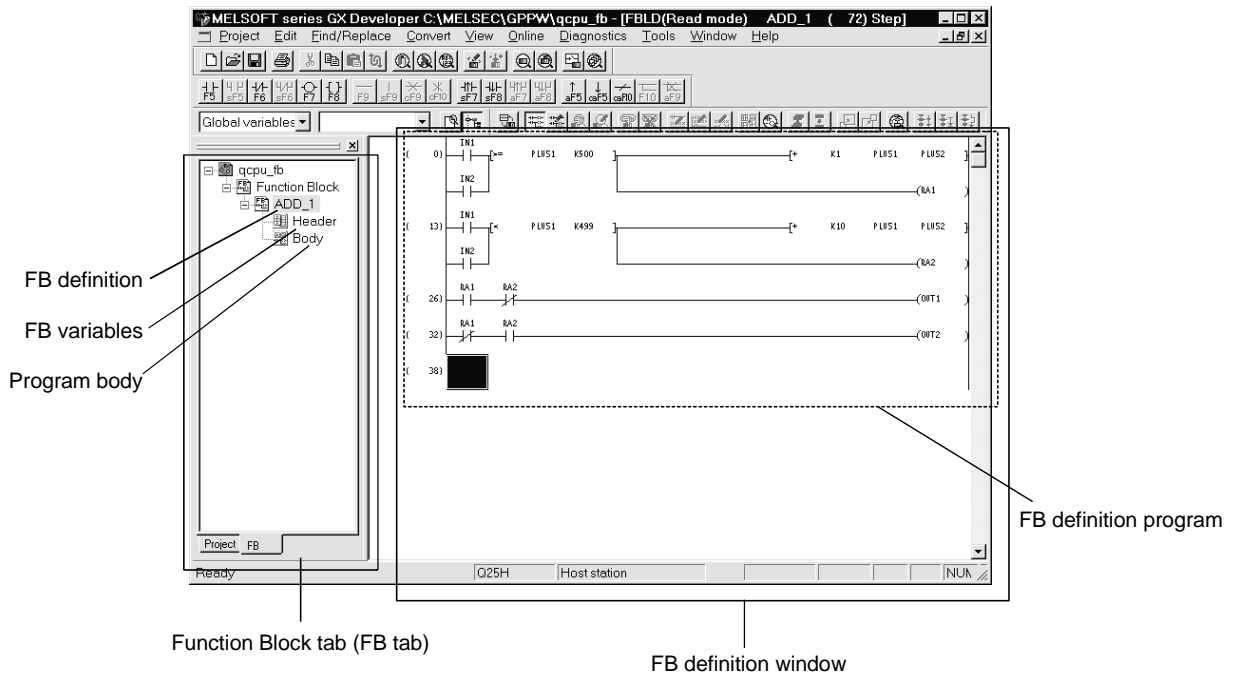

(2) Window used to create FB definition labels (variables)
(FB variable setting window)

This window is used to define the labels used for the FB definition.

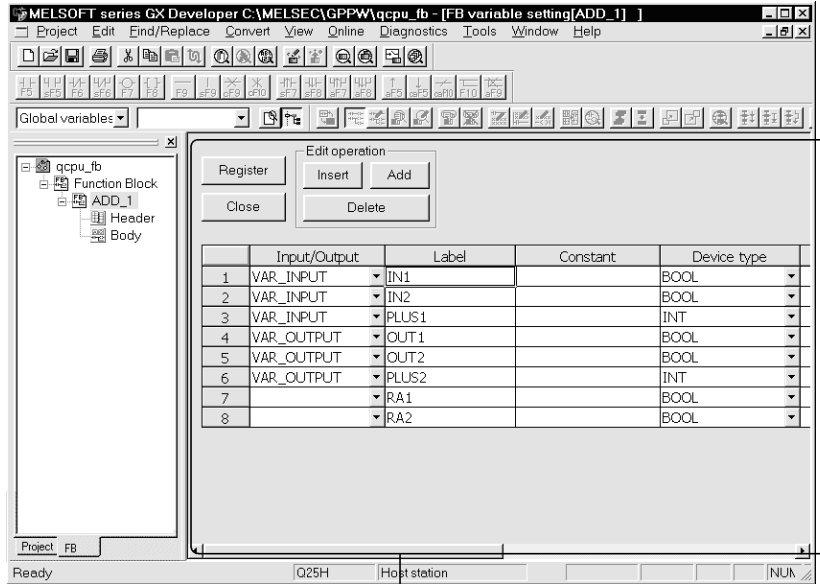

FB variable setting window

(3) Window used to create a sequence program
(Sequence program window)

This window is used to edit a sequence program where the FB is pasted.

Create the sequence program in a ladder format. A list format cannot be used.

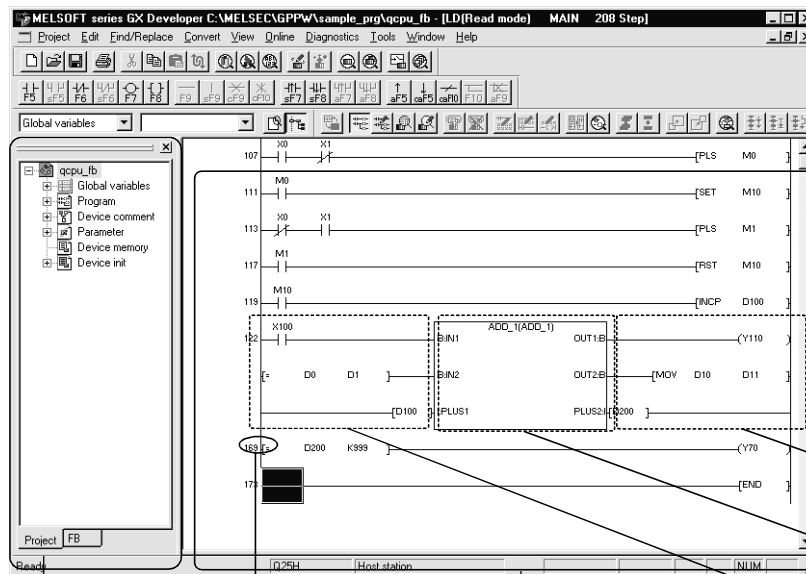

Project tab

*1

Sequence program window

Output ladder section

Function block (FB)

Input ladder section

*1: The step numbers of the sequence program, which is not yet compiled, are displayed with parentheses, i.e. (Step number).

After completion of compile, the step numbers are displayed without parentheses.

When compile is complete, the step numbers may be changed.

Name	Description
Function Block tab (FB tab)	Tab that displays the FB definition of the project data list.
FB variables (Header)	Label used for the FB definition.
FB definition	Data having a Body and Header as a pair.
FB definition window	Window used to edit an FB definition program.
FB definition program (body)	Program whose labels have been created on the FB definition window.
FB variable setting window	Window used to set FB variables.
Project tab	Table that displays project information in the project data list.
FB	Function block pasted to a sequence program.
FB section	Square symbol that represents the FB pasted to the sequence program.
Input ladder section	Input ladder on the left side of the FB section.
Output ladder section	Output ladder on the right side of the FB section.
Sequence program window	Window used to edit the sequence program where the FB is pasted.
FB definition name	Name of the FB definition displayed on the FB tab
FB name	Name of the FB pasted to the sequence program. Different names are attached to the FBs that are pasted from the same FB definition.
FB window	Window used to read or monitor the program in the FB pasted to the sequence program. The FB window cannot be used to write a program. Use the FB definition window to write a program.

1.4 What You Should Understand Before Using the FB

As in a normal sequence program, the FB is used to create a program using labels in a ladder or list format.

Before creating the FB, therefore, fully understand the way to create a sequence program using labels on GX Developer.

When you want to know any operation to create a sequence program on GX Developer, refer to the "GX Developer Version 7 Operating Manual" given in the related manuals.

1.5 Specifications

1.5.1 Compatible CPUs

The following CPU models allow you to use the FB on GX Developer.

PLC Series	Type
QCPU (Q mode)	Q02CPU, Q02HCPU, Q06HCPU, Q12HCPU, Q25HCPU
QnACPU	Q2ASCPU, Q2ASCPU-S1, Q2ASHCPU, Q2ASHCPU-S1, Q2ACPU, Q2ACPU-S1, Q3ACPU, Q4ACPU, Q4ARCPU

The FB is not available for the Q00JCPU, Q00CPU and Q01CPU of the QCPU (Q mode).
The FB is not available for the ACPU, QCPU (A mode), FXCPU and motion controller of the PLC series, either.

1.5.2 Specifications of and precautions for the FB

The following are the specifications of the FB and precautions for use of the FB.

- (1) For creation of FB definition program
(a) Specifications

Item	Specifications
Program capacity	500 steps
Number of labels usable as devices	500 pcs. <ul style="list-style-type: none"> • Input variables + I/O variables = 24 pcs. • Output variables + I/O variables = 24 pcs. (At least one input variable and one output variable are needed.) <ul style="list-style-type: none"> • Labels other than the input, output and I/O variables are used as internal variables.
Programming language	Ladder, list

- (b) Precautions

- 1) The FB cannot be used within the FB.
- 2) When the FB definition program has been corrected, online program correction cannot be made to the sequence program that includes the FB.
When writing the sequence program including the corrected FB to the PLC CPU, perform write to PLC in the online mode.
- 3) Index qualification is not available for labels.
To make index qualification, use an actual device as the target device.
- 4) If an internal variable is used as the result of a division instruction, its remainder cannot be used for control since a label cannot be assigned to the remainder of division.
To use the remainder of a division instruction for control, use an actual device as the device for storing the division result.

5) Since the numerical device that may be handled by an input variable is up to a double word, the instruction exceeding three words in input count cannot be input from the outside.

To input three or more words from the outside, use an actual device as the device for storing an input value or create the input instructions by the number of necessary times.

6) Since the numerical device that may be handled by an output variable is up to a double word, the instruction whose result will be three or more words cannot be output to the outside.

To output three or more words to the outside, use an actual device as the device for storing the result.

(2) For creation of sequence program including FB

(a) Specifications

Item	Specifications
Language of sequence program that can be created	Ladder
Pastable FB	Already compiled FB If you attempt to paste the FB not yet compiled, GX Developer displays an error message.
Number of FBs that may be pasted to one ladder block	1 pc. The output from the FB cannot be connected directly to the input of the other FB. If you want to connect the FBs, receive the output from the FB with a coil once, and then connect the contact of that coil to the input of the other FB.

(b) Precautions

1) A return connection cannot be used with an input ladder section and an output ladder section.

•Return connection cannot be programmed.

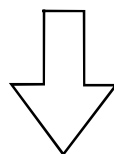
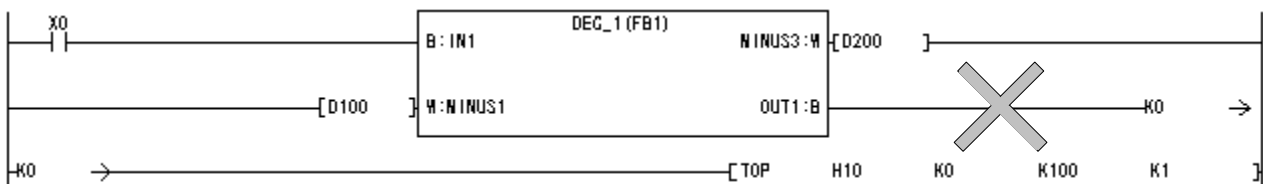

•Receive it with a coil once and then use the contact of that coil as the condition of the target instruction.

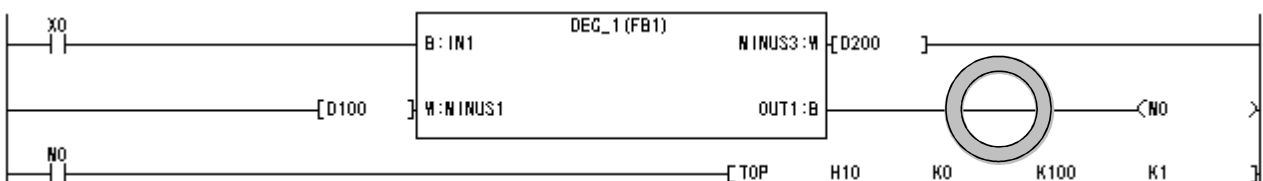

2) The FB cannot be used in SFC and MELSAP-L programs.

3) If the device type of the FB differs from that of the input or output ladder section, GX Developer displays an error message.

There are the following five FB device types.

- BOOL : Data represented by ON/OFF.
- INT : Data represented by 16 bits.
- DINT : Data represented by 32 bits.
- REAL : Floating-point data represented by 32 bits.
- STRING : Character string data represented by JIS8 code.

For example, connection of a contact to the input of the FB whose device type is a word will result in an error.

4) The FB definition automatically assigns devices to the labels used in a program. When creating a sequence program, avoid automatically assigned devices.

Like local devices, the automatically assigned devices are set in accordance with the automatically assigned device setting, which defaults to the following device ranges.

- Word device : D6144 to D12287
- Bit device : M4096 to M8191
- Timer : T64 to T2047
- Counter : C512 to C1023

2 GENERAL PROCEDURES FOR EDITING THE FB

The following flowcharts give the general procedures from project creation to debugging for use of the FB.

2

(1) Creating new sequence program using FB

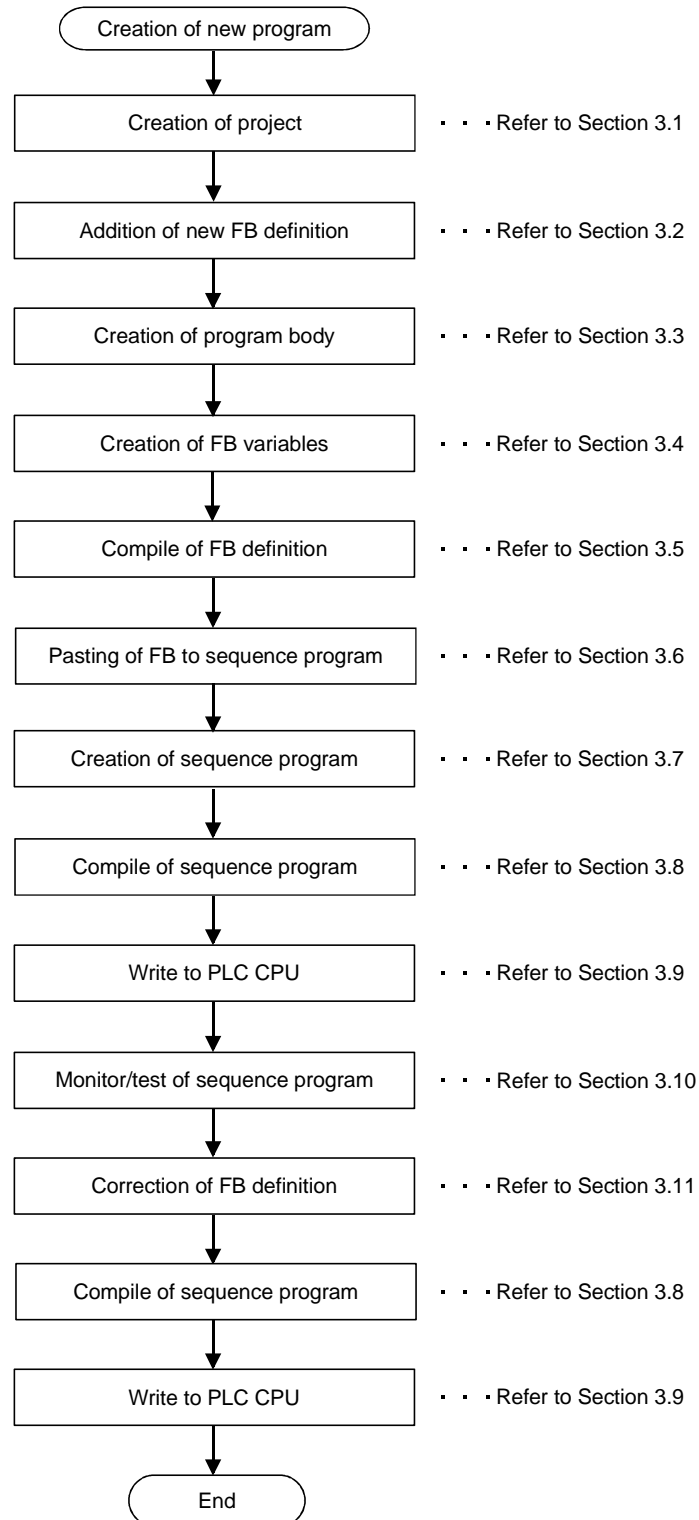

(2) Utilizing the existing FB to create a sequence program

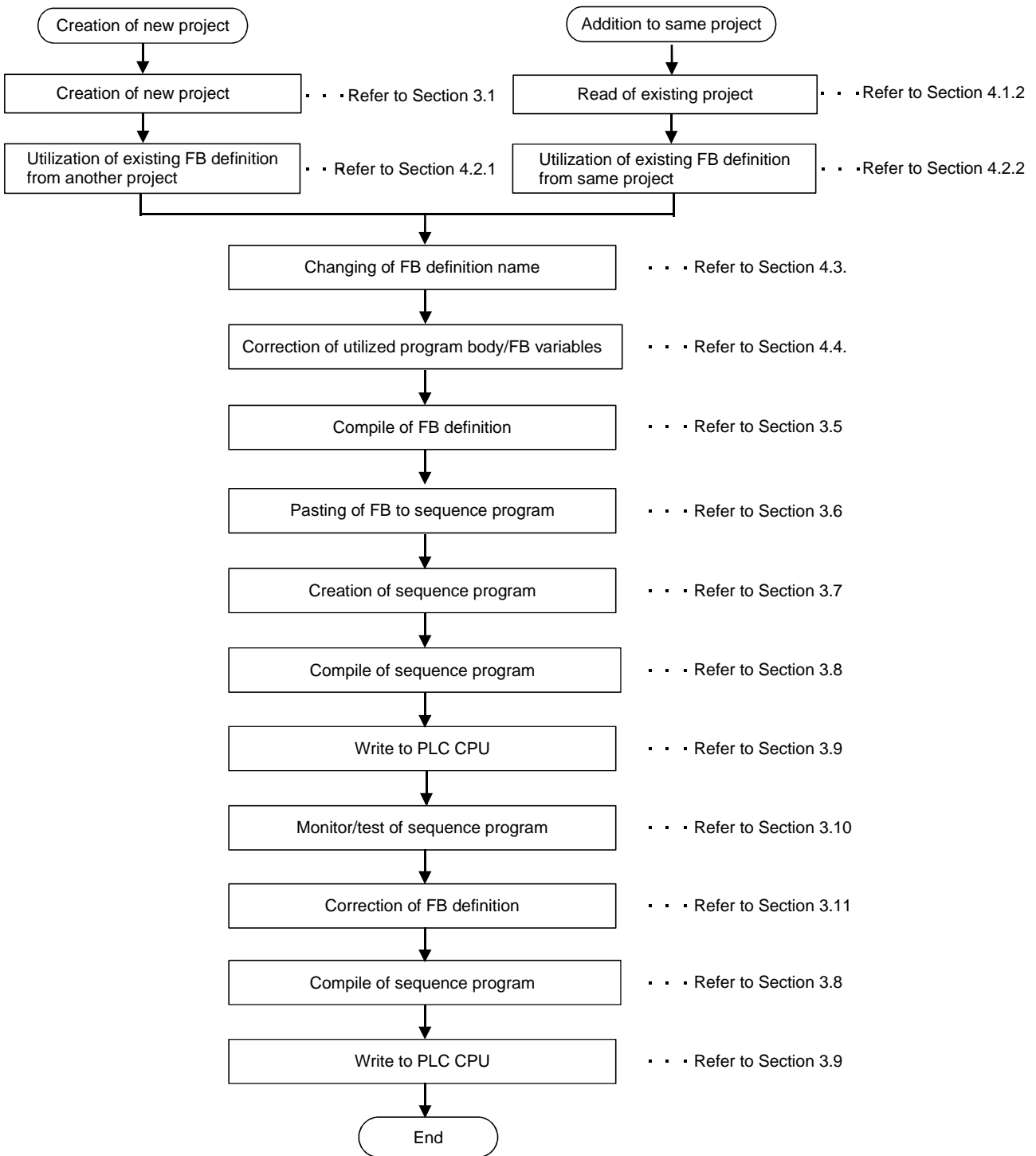

2

POINT
 This general procedure is for reference.
 Each operation can be performed in any order, independently of the above procedure.

3 CREATING NEW SEQUENCE PROGRAM USING FB

The following explains the operations to be performed to create a new sequence program using the FB.

This chapter is designed to create the following FB definition (program body, FB variables) and sequence program.

(1) FB definition (program)



(2) FB definition (FB variables)

	Input/Output	Label	Constant	Device type
1	VAR_INPUT	IN1		BOOL
2	VAR_INPUT	IN2		BOOL
3	VAR_INPUT	PLUS1		INT
4	VAR_OUTPUT	OUT1		BOOL
5	VAR_OUTPUT	OUT2		BOOL
6	VAR_OUTPUT	PLUS2		INT
7		RA1		BOOL
8		RA2		BOOL

(3) Sequence program

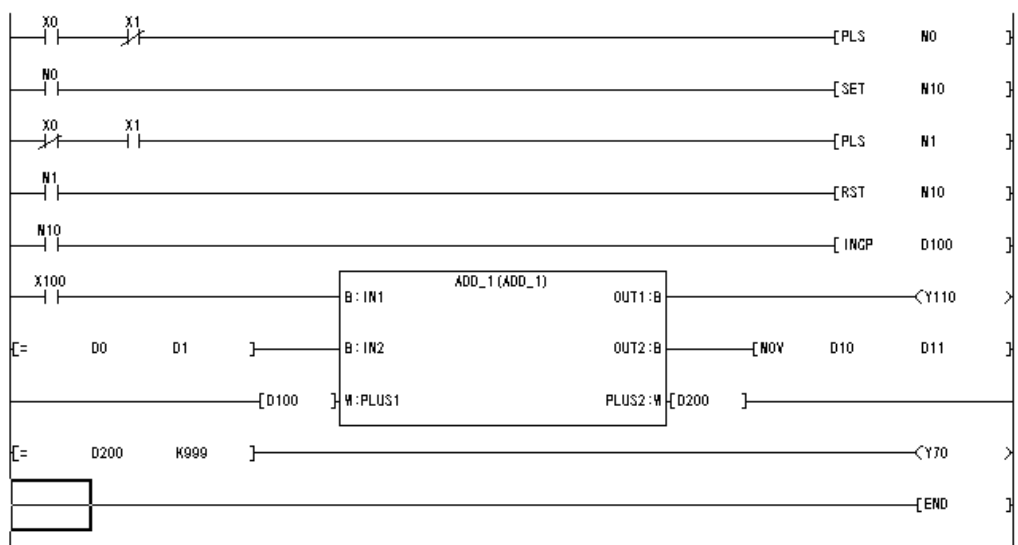

The sample project (qcpu_fb) of the sequence program described in this chapter is contained in the CD-ROM of this product.

After installing GX Developer, choose [Project]-[Open project] to open the sample project.

Handle the FB as described below.

- 1) Create a FB definition in the FB tab of the project.
- 2) Create the program body and FB variables of the FB definition.
- 3) Paste the FB definition registered to the FB tab to the sequence program.
- 4) Create the ladder block including the FB after pasting the FB.

Creation of new FB definition

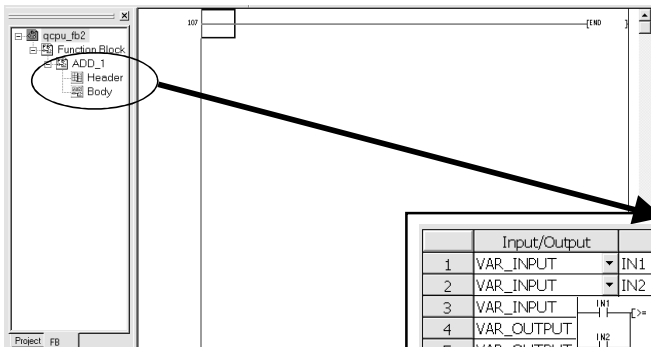

Creation of program body and FB variables

	Input/Output	Label	Constant	Device type
1	VAR_INPUT	IN1		BOOL
2	VAR_INPUT	IN2		BOOL
3	VAR_INPUT	IN1	PLUS1 K500	
4	VAR_OUTPUT	IN2		
5	VAR_OUTPUT	IN1		
6	VAR_OUTPUT	IN2	PLUS1 K499	
7				
8				

Registration of program body and FB variables

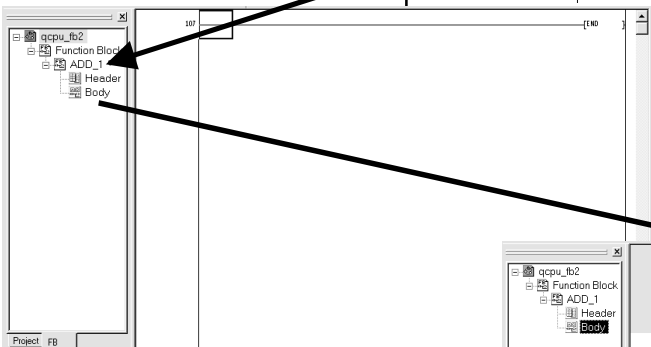

Pasting of FB to sequence program

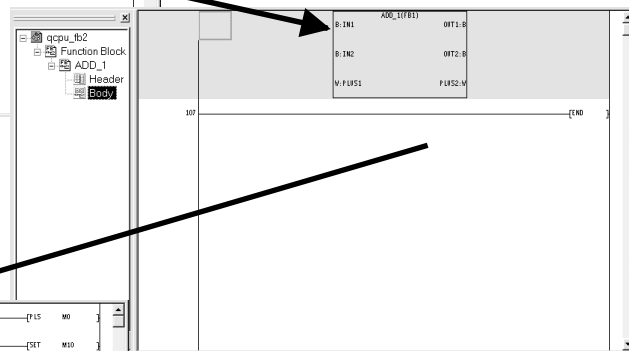

Creation of sequence program

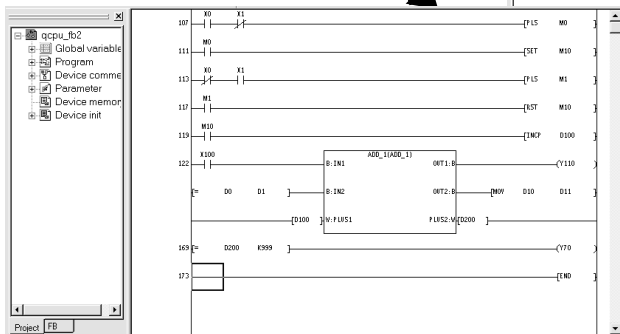

3.1 Crating New Project for FB

[Setting Purpose]

Set the PLC series, PLC type and project name necessary to create a new project for the FB.

[Operation Procedure]

Choose [Project] → [New project] or click  ([Ctrl] + [N]).

[Dialog Box]

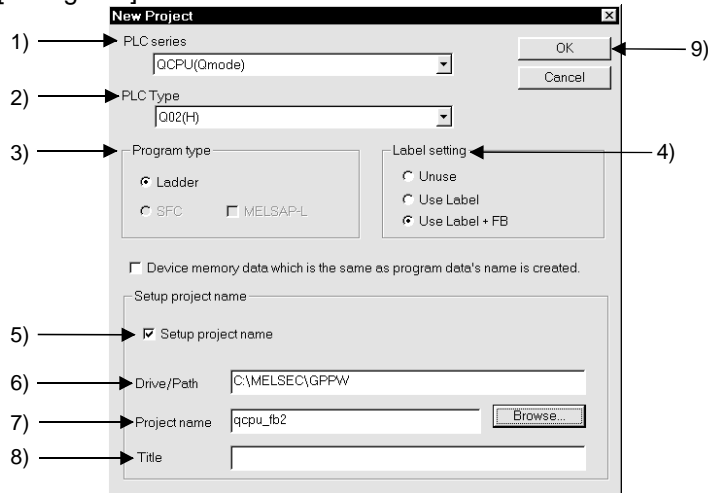

[Description]

1) PLC Series

As the PLC series, choose the QCPU (Q mode) or QnACPU.

2) PLC Type

As the PLC type, choose the CPU type to be used.

3) Program Type

When creating the FB, choose Ladder.

4) Label setting

When setting the FB, choose " Use Label + FB ".

5) Setup project name

Designate a project name to save the created data.

When designating a project name before creating a program, check the checkbox.

The project name can be designated before and after program creation.

When designating the project name after data creation, use the [Save As] menu.

6) Drive/Path

Set the path where the project will be saved (is saved).

Specifying only the project name without specifying the drive/path (blank) automatically creates the default drive/path and saves the project there.

7) Project name

Designates a project name.

The following shows the characters and the number of characters that can be used to designate a drive path, project name, or data name.

- Number of characters

The total number of characters used for designating both the project path and the project name (8 or more characters may be set) is 150.

<Example>

C:\SW3D5GPPW\ABCDEFGHIJKLMNPOQRSTUVWXYZ

- Characters not available in A, QnA and FX series

/, \, >, <, *, ?, " ", |, :, ; (: and \ can be set for drive designation only)

(: and \ are available only when the drive is specified.)

Any project name cannot be ended by a period (.).

8) Title

Sets the title for the project in up to 32 characters.

9) button

Click this button to create a new project.

3.2 Adding New FB Definition to the Created Project

[Setting Purpose]

Add a new FB definition for the new FB to the created project.

The FB definition consists of an FB Body and Header used to set the labels (variables) used in the program.

[Operation Procedure]

- Click the right button of the mouse on the <<FB>> tab and choose [New].
- Choose [Project] → [Edit Data] → [New].
- Click the right button of the mouse on the <<Project>> tab and choose [New].

[Dialog Box]

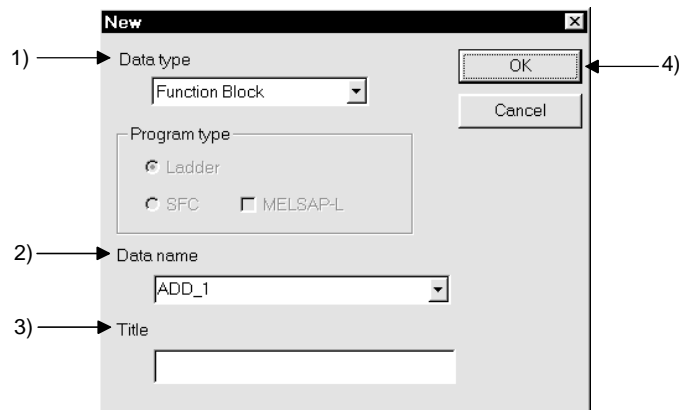

[Description]

1) Data type

Choose Function block.

2) Data name

Set the data name (FB definition name) to be added newly.

Set the data name within eight characters.

• Usable characters

Alphanumeric characters, _, ^, \$, , ~ (tilde), !, #, %, &, (), -, { }, @, * (apostrophe), ' (single quotation)

• Unusable characters

Any of " = | : ; , \ [] + * ? < > . / will result in an error.

If the other FB definition has already been created in the project, displaying the New dialog box sets that FB definition name in the Data name field.

8) Title

Sets the title for the project in up to 32 characters.

9) button

Click this button to create the new FB definition.

POINT

- (1) There are no restrictions on the number of FB definitions that can be created in a project. (It depends on the capacity of the project saving destination.)
- (2) If multiple FB definitions are created in one project, we recommend you to create a title for ease of searching for the object FB definition.

3.3 Creating FB Definition Program

[Setting Purpose]

Create an FB definition program using labels (variables).

[Operation Procedure]

Double-click Function block on the <<FB>> tab and double-click FB definition or double-click Body individually.

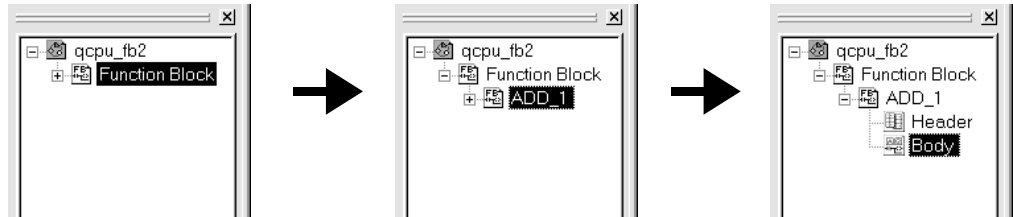

[Window]

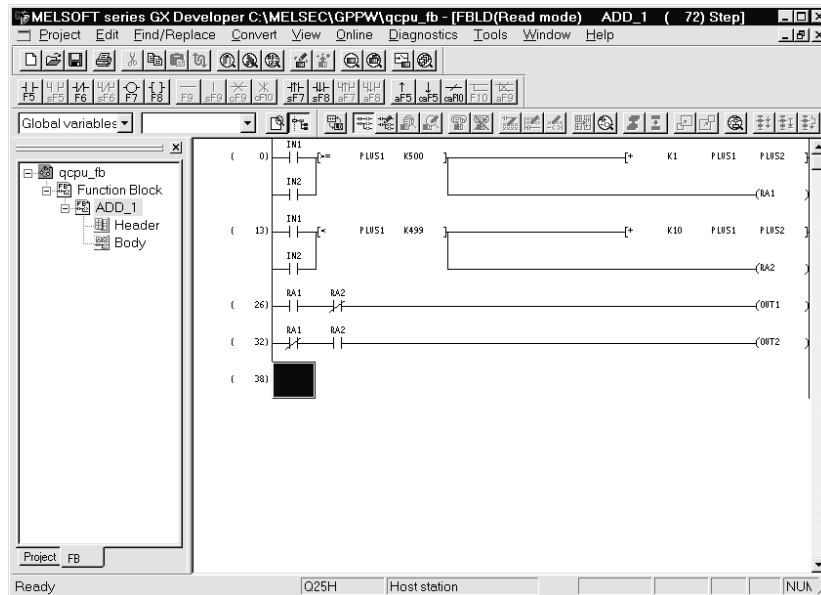

[Program Creation]

(1) To create an FB definition program, perform the same operation as in creating a normal sequence program on the FB definition window.

The program can be created in the following specifications.

Item	Description
Program capacity	Max. 500 steps
Language	Ladder, list
Supported mode	Write, read
Number of labels	Max. 500 pcs.

(2) Use labels (variables) to create the program.

The used labels define the following four different functions. Use FB variables to define the labels. (Refer to Section 3.4.)

Type	Description
Input variable	Variable input from the FB outside. Up to 24 pcs. including I/O variables, at least 1 pc.
Output variable	Variable output to the FB outside. Up to 24 pcs. including I/O variables, at least 1 pc.
I/O variable	Variable having the functions of both the input and output. Up to 24 pcs.
Internal variable	Variable used only in the FB inside. {500 - (input variables + output variables + I/O variables)} pcs.

Create a label within 16 characters.

Characters that cannot be used as a label are those of the reserved words and actual device names.

If the characters of the reserved word or actual device name are used, re-set the other label name as the "The reserved word is used." or "Device name is used." error message appears. Refer to Appendix 1 for unusable character strings.

REMARK

Though the FB definition allows a program to be created using actual devices (e.g. X100, Y110), it will be difficult to use multiple pieces of the same FB definition in a sequence program. (We cannot recommend this as it may result in double-coil.)

The following program example is used to explain how to use labels.

(a) FB definition program using labels

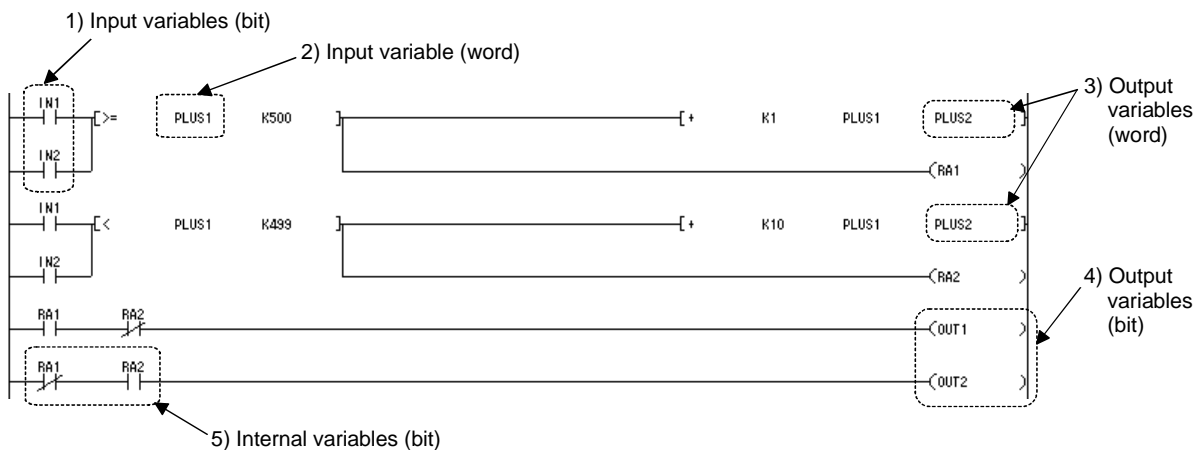

- 1) IN1 and IN2 are variables that turn ON/OFF using external ON/OFF information as conditions.
- 2) PLUS1 is a variable that inputs external numerical information to the FB inside.
- 3) PLUS2 is a variable that outputs the result calculated in the FB inside (numerical information) to the outside.
- 4) OUT1 and OUT2 are variables that control external outputs with the results calculated in the FB inside (ON/OFF information).
- 5) RA1 and RA2 are variables used in the FB inside only.

(b) Operation example of the sequence program using the created FB definition

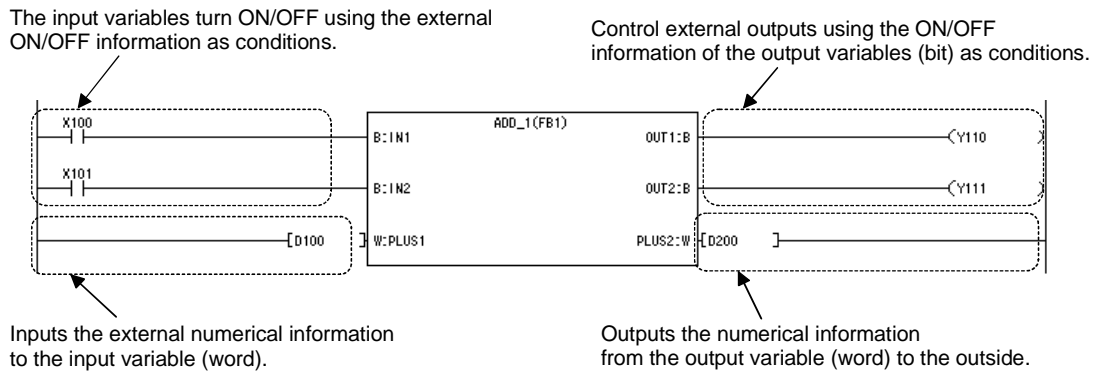

- (3) The other FB cannot be used in the FB definition program.
- (4) For the FB definition, do not create the program that jumps to outside the FB definition. (Example: CALL instruction that jumps to a subroutine program)
- (5) Create a program on the FB definition window, starting with step 0. The FB definition program does not have an END instruction. Entry of an END instruction will display an error.
- (6) After program creation is complete, convert the program. Make program conversion in any of the following three operations.
 - (a) **F4** key
 - (b) [Convert] → [Convert]
 - (c) Right-click on the FB definition window and then choose [Convert].
- (7) The program created in the program body cannot be used in the sequence program if it has only been converted. The program created can be used in the sequence program after the labels have been defined by the FB variables and the FB definition has been compiled. GX Developer is initialized to perform up to compile when Compile option is used for conversion. Compile option can be set by choosing [Convert] → [Compile option].

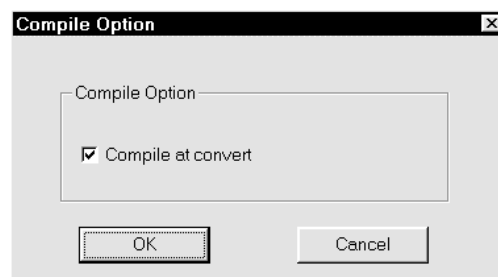

On the FB definition window, the window title is provided with "*" to indicate that the program is not compiled.

MELSOFT series GX Developer C:\MELSEC\GPPW\qcpu_fb2 - [FBLD(Edit mode) ADD_1 (34) Step *]

* : Not yet compiled
 No marking: Already compiled

- (8) Note the following when creating the FB definition program with labels.
- (a) Index qualification cannot be used with labels.
 An index-qualified label is recognized as a new label.
 (Example)
 When "PLUS1Z1" is input to qualify the label "PLUS1" with the index register "Z1", the FB definition program is recognized as the label "PLUS1Z1".
 (Action)
 Use an actual device as the device to be index-qualified.
- (b) When an internal variable is used as the result of a division instruction, its remainder cannot be used for control since a label cannot be assigned to the remainder of division.
 (Example)
 "/ PLUS 1 K10 PLUS2 " stores the division result into the PLUS2 label of the internal variable, but there is no label for storing the remainder of division.
 (Action)
 When you want to use the remainder of a division instruction for control, use an actual device as the device for storing the division result.
- (c) Since the numerical device that may be handled by an input variable is up to a double word, the instruction exceeding three words in input count cannot be input from the outside.
 (Example)
 For the data write instruction "TO" to the intelligent function module, up to two words can be input by an input variable.
 (Action)
 To input three or more words from the outside, use an actual device as the device for storing an input value or create the input instructions by the number of necessary times.
- (d) Since the numerical device that may be handled by an output variable is up to a double word, the instruction whose result will be three or more words cannot be output to the outside.
 (Example)
 For the BIN 32-bit multiplication "D*", the device for storing the multiplication result needs four words.
 (Action)
 To output three or more words to the outside, use an actual device as the device for storing the result.

POINT

Online program correction cannot be made to the FB definition if the program is corrected.
 If program correction has been made, compile the program and then perform online write to PLC to write it to the PLC CPU.

REMARK

This manual does not detail the operations for creating programs.
 For details of the operations for creating programs, refer to the GX Developer Version 7 Operating Manual given in the related manuals.

3.4 Creating FB Variables

[Setting Purpose]

Set the variable types, constant values, device types and comments to the labels (variables) used in the FB definition program.

The FB variables must be paired with the FB definition program body.

[Operation Procedure]

Double-click Function block on the <<FB>> tab and double-click "Header" or double-click Header individually.

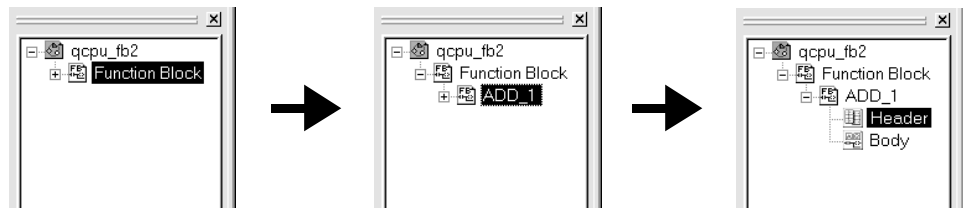

[Window]

7) Register 6) Edit operation

Register Insert Add
Close Delete

	Input/Output	Label	Constant	Device type	Comment
1	VAR_INPUT	IN1		BOOL	
2	VAR_INPUT	IN2		BOOL	
3	VAR_INPUT	PLUS1		INT	
4	VAR_OUTPUT	OUT1		BOOL	
5	VAR_OUTPUT	OUT2		BOOL	
6	VAR_OUTPUT	PLUS2		INT	
7		RA1		BOOL	
8		RA2		BOOL	

1) 2) 3) 4) 5)

[Description]

1) Input/Output

Choose the label type. There are the following four different types.

- VAR_INPUT: Variable input from the FB outside
- VAR_OUTPUT: Variable output to the FB outside
- VAR_IN_OUT: Variable having the functions of both the input and output
- "Blank": Variable used in the FB inside

2) Label

Set the label (variable) used in the FB definition program.

3) Constant

Set a constant value when you want to set a constant to the label where "Blank" has been selected for the variable type.

Enter a constant value with K, H, E or " " for ease of identifying that it is a decimal, hexadecimal, real number or character string constant.

4) Device type

- For the input, output and I/O variables, choose any of Bit, Word, Double word, Real number and Character string.

The contents of the devices are as follows.

- 1) BOOL : Data represented by ON/OFF.
 - 2) INT : Data represented by 16 bits.
 - 3) DINT : Data represented by 32 bits.
 - 4) REAL : Floating-point data represented by 32 bits.
 - 5) STRING : Character string data represented by JIS8 code.
- For the internal variable, choose any of ARRAY, TIMER, COUNTER, STORED TIMER and POINTER.
- 6) Array: Specify the number of data to be handled when multiple data, such as the BMOV or FMOV instruction, are handled.

Selecting STRING or ARRAY displays the corresponding one of the following dialog boxes.

Number of letters

: The input range is 1 to 50 characters.

Number of elements

: The input range is 1 to 255.

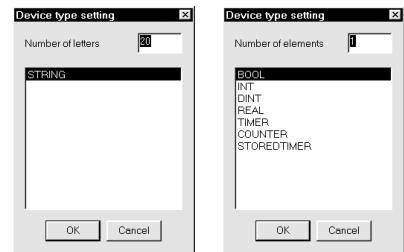

5) Comment

Set a comment within 64 characters.

The comment set in this field appears under the label within the FB when the sequence program is displayed with comments.

When FB pasted to sequence program is displayed with comments

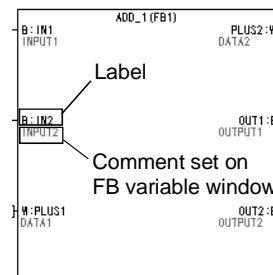

6) Edit operation

Insert button

Used to insert a blank row in the current cell position.

When you want to batch-insert multiple rows, choose the cells of the rows you want to insert. Blank rows are inserted in the cell-selected range.

Add button

Used to add a blank row under the row of the current cell position.

When you want to batch-add multiple rows, choose the cells of the rows you want to add. Rows are added, starting with the row under the first one of the range-selected cells.

Delete button

Used to delete the cell-selected range.

7) **Resister** button

Clicking the **Resister** button registers the FB variables.

If any of the labels, constant values and device types is set incorrectly, the dialog box on the right appears to indicate that the variables cannot be registered.

Choosing Contents of error and clicking the Jump button displays the error location.

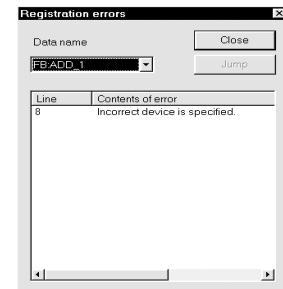

POINT

On the FB variable setting window, the set data are sorted in label order, constant order and device type order. The sorting order is as follows.

1. Symbols
2. Alphabets (uppercase characters)
3. Alphabets (lowercase characters)

The FB definition automatically assigns devices to the labels used in the program. When creating a sequence program, avoid automatically assigned devices.

Like local devices, the automatically assigned devices are set in accordance with the automatically assigned device setting, which defaults to the following device ranges.

- 1) Word device : D6144 to D12287
- 2) Bit device : M4096 to M8191
- 3) Timer : T64 to T2047
- 4) Counter : C512 to C1023

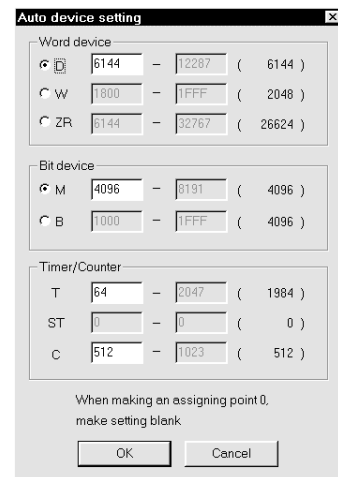

When you want to change the device range, choose [Edit] → [Auto device setting] to display the Auto device setting dialog box, and change the device range.

REMARK

For details of the operations performed on the Auto device setting dialog box, refer to "Label Program" in the GX Developer Version 7 Operating Manual.

3.5 Converting the FB Definition (Compile)

[Setting Purpose]

Convert the created FB definition so that it may be used in a sequence program.

[Operation Procedure]

Choose [Convert] → [Compile].

[Operation Items]

(1) The following dialog box appears on normal completion of compile.



Click YES to write the label comments over the device comments.

(2) The following dialog box appears on detection of errors during execution of compile.

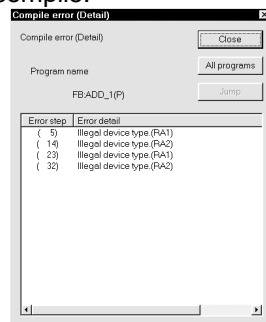

Choosing Contents of error and clicking the Jump button displays the error locations.

(3) When errors are detected, correct the error locations and then execute compile again.

In the sequence program, you can use only the FB definition that has completed compile.

(4) When you have created multiple FB definitions, you can compile all FB definitions by performing compile operation once. The dialog box shown in (2) appears on detection of errors during execution of compile.

Clicking **All programs** shows the dialog box which allows you to confirm the number of errors in all programs.

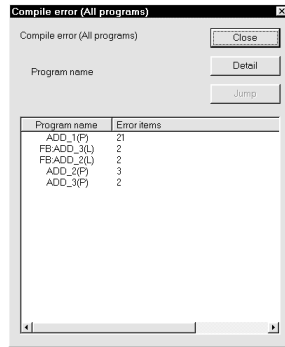

(Display example)

- [ADD_1(P)] Number of errors in FB definition ADD_1
- [FB:ADD_3(L)]... Number of errors in FB definition ADD_3
- [FB:ADD_2(L)]... Number of errors in FB definition ADD_2
- [ADD_2(P)] Number of errors in FB definition ADD_2
- [ADD_3(P)] Number of errors in FB definition ADD_3

Choosing the program name and clicking **Detail** displays the detailed dialog box of the selected item.

3.6 Pasting the Converted FB to Sequence Program (FB Utilization)

3.6.1 Pasting the FB definition to sequence program

[Setting Purpose]

Paste the FB definition to the sequence program being created so that the FB may be used.

[Setting Procedure]

Any of the following three different operations can be performed to utilize the FB.

- (1) Method using drag and drop from the FB tab with the mouse
- (2) Method using the function block utilization dialog box
- (3) Method using the instruction dialog box

The following explains the procedures of the above operations.

- (1) Method using drag and drop from the FB tab with the mouse

- (a) Display the sequence program where the FB definition will be pasted.

Select the target sequence program name from the Project tab to display the sequence program.

Set the mode to Ladder (Write).

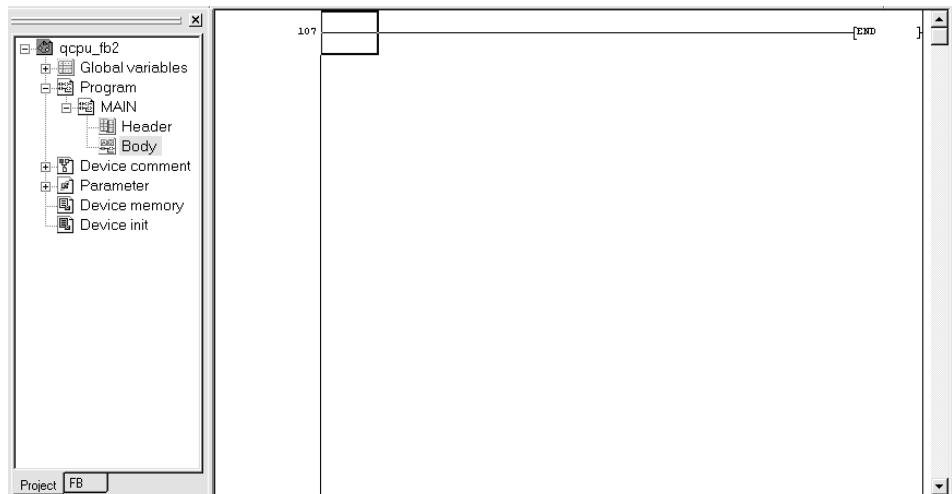

(b) Switch from the Project tab to the FB tab, and drag and drop the FB definition from the FB tab onto the sequence program.

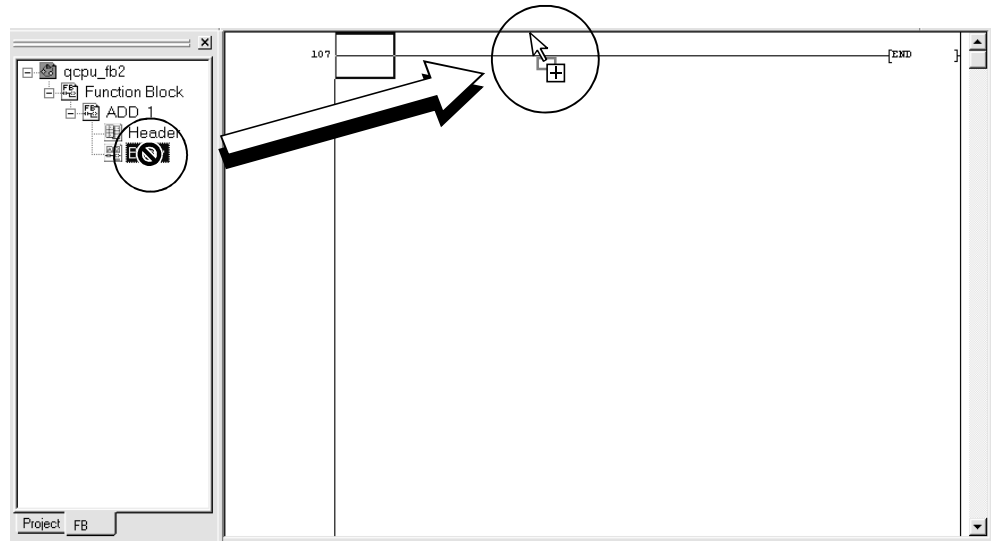

(c) The FB appears in the cursor-specified place (drop position) on the sequence program.

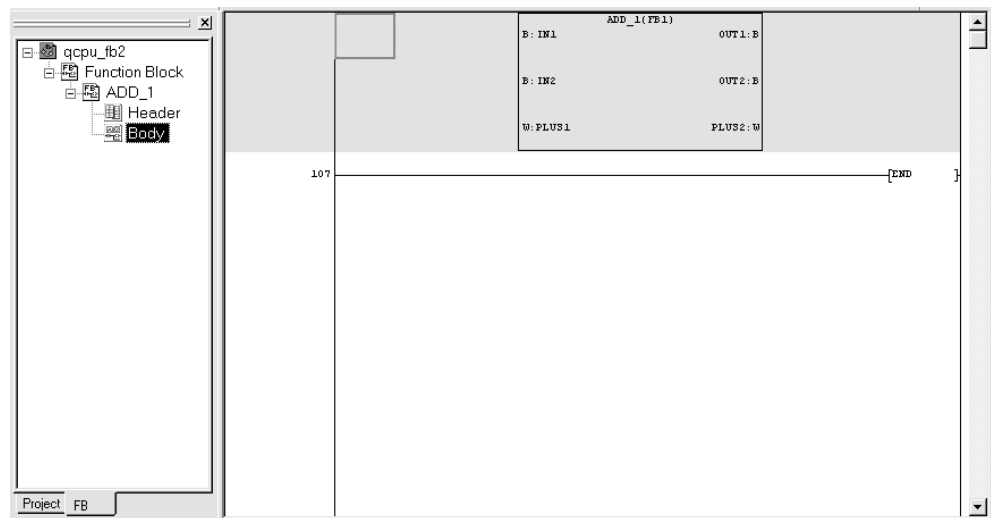

POINT

- (1) The position where the FB definition will be pasted is determined by the place specified by the cursor.
 - (a) When the paste position is a ladder block other than the FB
(In the insert/overwrite mode) It is inserted in the row above the ladder block of the paste position.
 - (b) When the paste position is a ladder block including the FB
(In the insert mode) It is inserted in the row above the ladder block of the paste position.
(In the overwrite mode) It is written over the FB of the paste position.
- (2) There are no restrictions on the number of FBs pasted to the sequence program.

(2) Method using the function block utilization dialog box

(a) Display the sequence program where the FB definition will be pasted.

Select the target sequence program name from the Project tab to display the sequence program.

Set the mode to Ladder (Write). (Perform the same operation as in (1)-(a).)

(b) Choose [Project] → [Function Block] → [Diversion] to display the Function Block diversion dialog box.

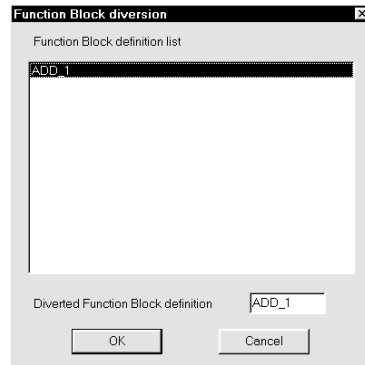

Double-click the FB definition name to be utilized from the Function Block diversion dialog box.

Alternatively, click and choose the FB definition name to be utilized, and click the **OK** button.

(c) The FB appears in the cursor-specified place (drop position) on the sequence program. (This is the same as in (1)-(c).)

(3) Instruction list input dialog box

(a) Display the sequence program where the FB definition will be pasted.

Select the target sequence program name from the Project tab to display the sequence program.

Set the mode to Ladder (Write). (Perform the same operation as in (1)-(a).)

(b) From the keyboard, enter "FB. 'FB definition name'" in the sequence program.

This displays the Enter symbol window and writes it in the device instruction input field. Example: FB.ADD_1



(c) Clicking the **OK** button displays the FB in the cursor-specified place on the sequence program.

(This is the same as in (1)-(c).)

3.6.2 Changing the name (FB name) of the pasted FB (FB name changing)

This operation is optional. Perform this operation as necessary.

[Setting Purpose]

Change the FB name of the pasted FB.

POINT

The FB name "(FB1)" of the FB pasted to the sequence program is displayed within parentheses "(")" after the FB definition name.

FB definition name ADD_1 (FB1) FB name

B: IN1	OUT1: B
B: IN2	OUT2: B
W: PLUS1	PLUS2: W

If multiple pieces of the same FB or the other FBs are pasted to a sequence program, the FBs are automatically assigned the specific FB names that increase in number consecutively, e.g. "FB1", "FB2", "FB3".

Perform this operation when you want to make multiple FBs pasted to a sequence program more easily identifiable.

[Operation Procedure]

Choose [Project] → [Function Block] → [Rename FB].

[Setting Procedure]

(1) Type the old data name and new data name in the Rename Function Block dialog box.

You can select the old data name from the list box.

If you reselect the FB whose name will be changed, the FB name has already been entered in the Data name before changing field.

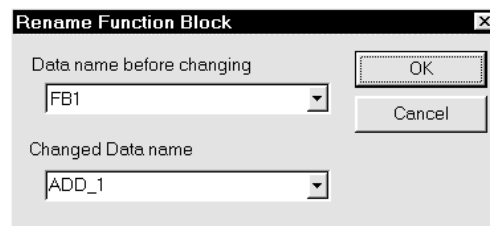

The FB name that may be entered is within 16 characters.

The characters that cannot be used as the FB name are those of the reserved words and actual device names.

If you used the characters of the reserved word or actual device name, the following error message will appear. Therefore, set the other label name. Refer to Appendix 1 for the unusable character strings.

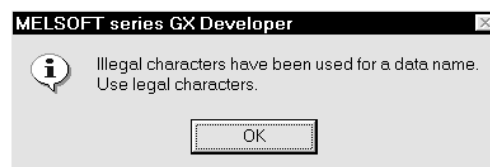

(2) Click the button to display the new FB name in the FB.

When you have changed the FB name, the display changes as shown below.

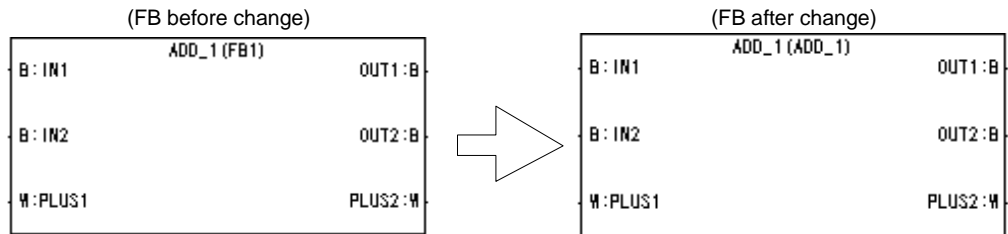

POINT

FB name changing can be executed in the write mode.
It cannot be executed in the read mode.

3.7 Creating the Sequence Program

3.7.1 Editing the sequence program

[Setting Purpose]

Create an input ladder section and an output ladder section for the FB pasted to the sequence program.

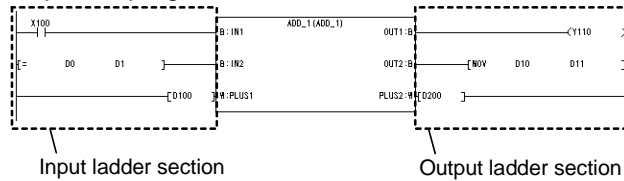

Add other ladders to the FB where the input and output ladder sections have been created to complete the sequence program.

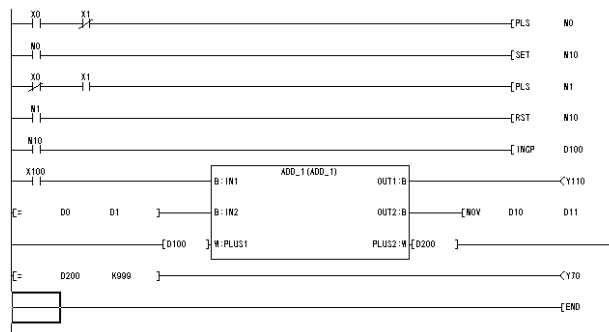

[Program Creation]

(1) After the FB has been pasted, the sequence program can be created by performing the same operation as in creating a normal ladder format sequence program.

REMARK

This manual does not detail the operations for creating programs. For details of the operations for creating programs, refer to the GX Developer Version 7 Operating Manual given in the related manuals.

(2) In the pasted FB, the labels of the input variables are displayed on the left side and those of the output variables on the right side. The input side labels are shown as "'Device type' : 'Label name'" and the output side labels as "'Label name' : 'Device type'".

The device types are indicated by the following alphabets.

- (a) BOOL : B
- (b) INT : W
- (c) DINT : D
- (d) REAL : E
- (e) STRING : S

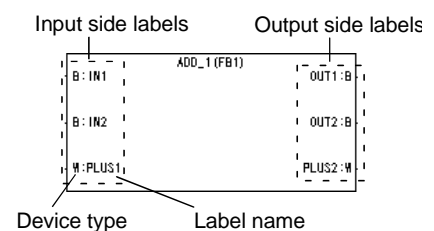

(3) Each label is connected with the input or output ladder section.

The ladder that can be connected to the input or output ladder section depends on the device type of the connected label.

(a) When the device type is BOOL

- 1) In the input ladder section, create instructions that will be conditions for input variables, e.g. contact, association and comparison operation instructions.
- 2) In the output ladder section, create instructions that will provide outputs, e.g. output and arithmetic operation instructions. The output variable will be a condition for the output instruction.

(b) When the device type is INT/DINT/REAL/STRING

- 1) Connect a word device (including a digit-specified bit device or constant) to the input ladder section. The information of the word device is stored into the input variable.
- 2) Connect a word device (including a digit-specified bit device) to the output ladder section. The information of the output variable is stored into the word device.

To create the ladder where the word device will be connected, click the  button or press the **F8** key to display the Enter symbol window, and enter the device in the device instruction input field. (When the device type is a DINT/REAL/STRING, consecutive devices starting with the entered device are occupied.)

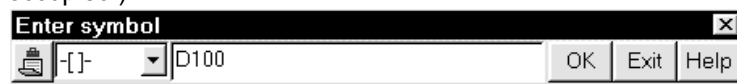

The following is the example where the input and output ladder sections have been connected to the FB.

Connect a contact for the condition that turns ON/OFF the input variable (BOOL).
In this example, IN1 turns ON when X100 turns ON.
When D0 = D1, IN2 turns ON.

The output variables (BOOL) will be conditions that control the external outputs.
In this example, Y110 turns ON when OUT1 turns ON.
When OUT2 turns ON, [MOV D10 D11] is executed.

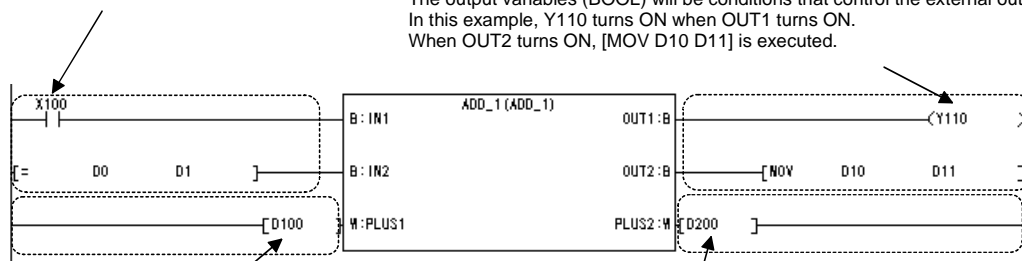

Connect a data register for inputting numerical information from the outside to the input variable (INT).
In this example, the numerical information of D100 is stored into PLUS1.

Connect a data register for outputting numerical information from the output variable (INT) to the outside.
In this example, PLUS2 stores the numerical information into D200.

The display specifications of the input and output ladder sections are as follows.

- (a) Display width of the input ladder section: Equal to the widths of four contacts
- (b) Display width of the output ladder section: Equal to the widths of three contacts + one coil

Return connection cannot be made in the input and output ladder sections. Therefore, when a ladder cannot be created in the above display width, use an internal relay or like to continue the ladder in the other ladder block.

- (4) The input variable/output variable of the FB does not result in an error if it is not connected from the input ladder section/output ladder section.
 After conversion of the sequence program, the unconnected input variables/output variables are displayed in the form that they are connected to the FB by horizontal lines from the left bus in the input ladder section or from the right bus in the output ladder section.
 In this case, the input variables are indefinite and the output variables are not output to the outside.

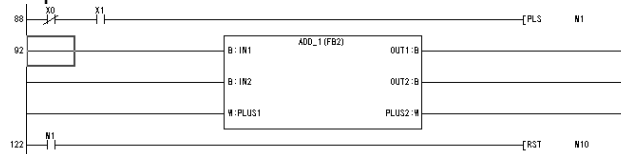

- (5) Edit the sequence program that includes the FB as described below.
- Cut/copy can be made in one ladder block including the FB.
 Cut/copy cannot be made only in any ladder section of the input ladder section, FB and output ladder section.
 Since the copied FB is judged as the FB different from the copy source FB, the FB name changes automatically from "FB1" to "FB2" to "FB3".
 - A row can be inserted in one ladder block including the FB.
 - A row can be deleted in one ladder block including the FB.
 - A column cannot be inserted where a ladder return occurs.
 - A column can be deleted in the input ladder section/output ladder section.
 - Macro registration/utilization cannot be performed in the ladder block that includes the FB.

3.7.2 Confirming the data of the pasted FB

[Setting Purpose]

In the pasted status, the data of the FB pasted to the sequence program are hidden to simplify the display of the sequence program.

Perform this operation when you want to confirm the data of the FB during creation of the sequence program.

[Operation Procedure]

(1) Double-click the corresponding FB.

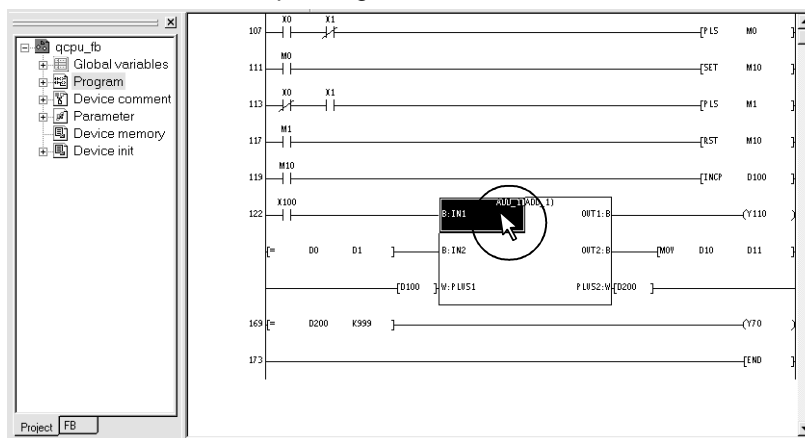

(2) The FB window appears.

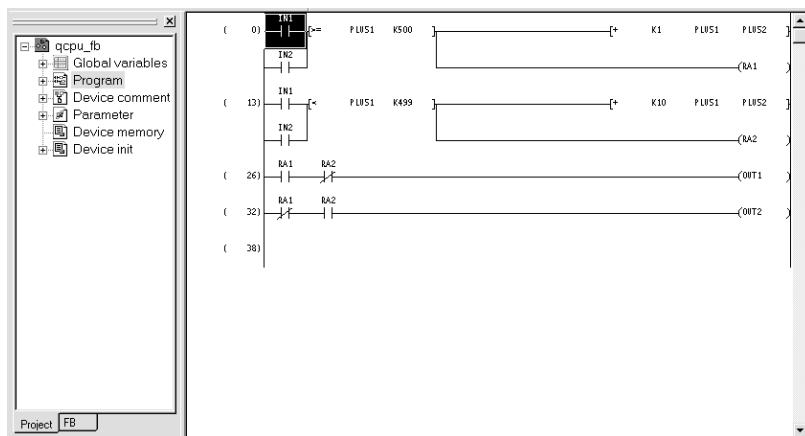

The following dialog box appears if the FB definition window or FB variable setting window has already been displayed.

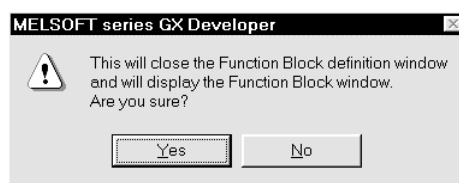

Clicking the **Yes** button closes the FB definition window or FB variable setting window and displays the FB window.

POINT

The FB window is used to read, monitor and test an FB program. Program correction cannot be made on this window.

When correcting the FB program, open the FB definition window.

The FB window closes when the FB definition window opens.

3.7.3 Searching/replacing the sequence program (Search/replace)

[Setting Purpose]

Perform this operation when searching for or replacing a device, instruction or like in the created sequence program.

[Operation Procedure]

Choose [Find/Replace] → [Find device], [Find instruction], [Find step no.], [Find character string], [Find contact or coil], [Replace device], [Replace instruction], [Change open/close contact], [Replace character string], [Change module start address], [Replace statement/note type], [Cross reference list], [List of used device].

REMARK

This manual does not detail the search/replace operations.
For details of the search/replace operations, refer to the GX Developer Version 7 Operating Manual given in the related manuals.

[Item Explanation]

(1) Search/replace differs in execution range as described below depending on the target window.

Target Window	Execution Range
Sequence program window	The sequence program being displayed is the target of search/replace. However, the pasted FB is not included in the target. *1
FB definition window	Only the FB definition program being displayed is the target of search/replace.
FB window	Only the FB definition program being displayed is the target of search.

(2) Search/replace is usable on the windows as indicated below.

Search/Replace Item	Sequence Program Window	FB Definition Window	FB Window
Find device Find instruction Find step no. Find character string Find contact or coil	Can be executed.	Can be executed.	Can be executed.
Replace device Replace instruction Change open/close contact Replace character string Change module start address Replace statement/note type	Can be executed.	Can be executed.	Cannot be executed.
Cross reference list List of used device	Can be executed.	Can be executed.	Can be executed.

*1: Only character string search can search the FB pasted to the sequence program for the FB definition name or FB name.

POINT

When searching for the FB pasted to the sequence program, you can find the object FB easily by specifying the FB definition name or FB name of the target FB in character string search.

(1) After typing the FB definition name or FB name, click the **Find Next** button.

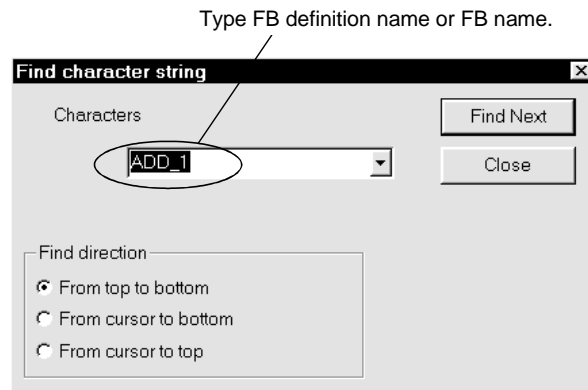

(2) The cursor moves to the top left of the FB section.

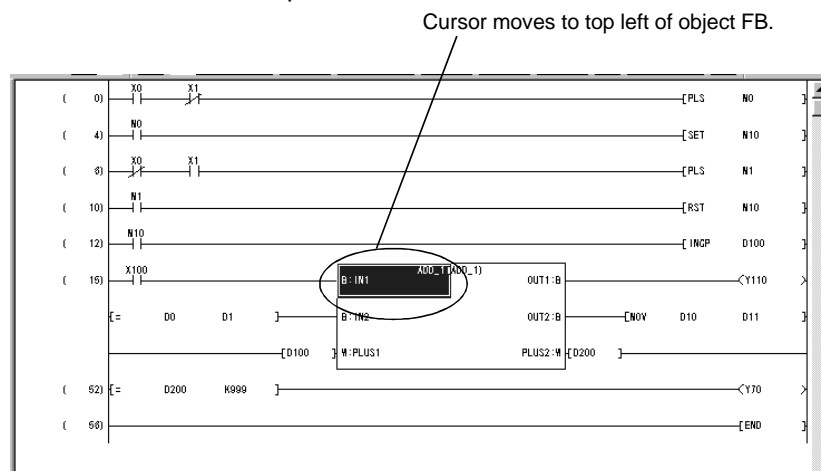

3.7.4 Creating/displaying the comments, statements or notes (Sentence creation)

[Setting Purpose]

Create comments, statements or notes in the sequence program to improve the readability of the program.

The created comments, statements or notes can be displayed by setting the display format.

[Operation Procedure]

(1) Creation procedure

Choose [Edit] → [Documentation] → [Comment], [Statement] or [Note]

(2) Display procedure

Choose [Edit] → [Comment], [Statement] or [Note].

REMARK

This manual does not detail the operations for creating comments, statements and notes.

For details of the creating operations, refer to the GX Developer Version 7 Operating Manual given in the related manuals.

[Description]

(1) Comment

Comments can be created for the devices in the input and output ladder sections of the ladder block that includes the FB.

(2) Statement

Statements can be created in only the first ladder of the input ladder section in the ladder block that includes the FB.

They cannot be created in the output ladder section.

(3) Note

Notes can be created in only the output ladder section of the ladder block that includes the FB.

They cannot be created in the input ladder section.

3.8 Converting the Sequence Program into Program to Be Executed on the PLC CPU (Compile)

[Setting Purpose]

The sequence program where the FB has been pasted cannot be executed as-is on the PLC CPU. Perform compile operation to convert it into an executable program.

[Operation Procedure]

Choose [Convert] → [Compile], [Compile(All programs being edited)] or [Compile(All programs)].

POINT

When you choose [Convert] → [Compile option] and select "Compile at convert", performing conversion operation after writing the sequence program also executes compile at the same time. (The default is "Compile at convert".)

[Description]

(1) The following dialog box appears on normal completion of compile.

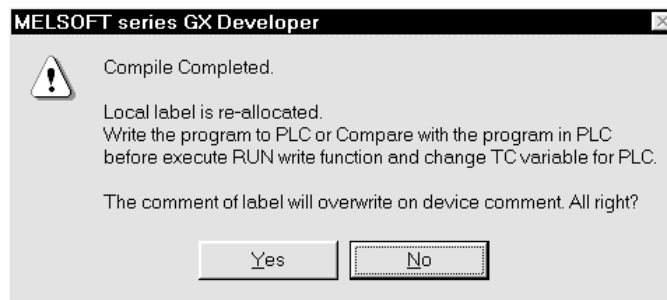

The following dialog box appears on detection of errors.

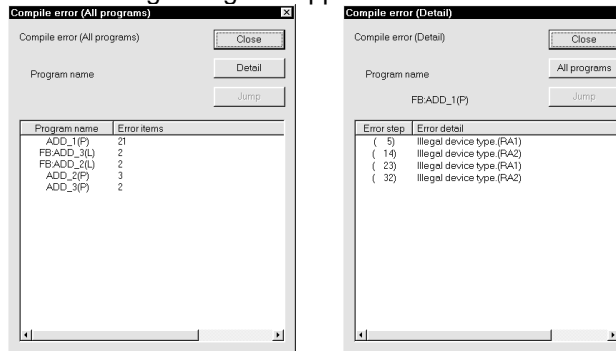

"Compile error (All programs)" appears if errors occurred over multiple programs.

"Compile error (Detail)" appears if errors occurred in one program only.

(2) If not compiled, the sequence program is provided with "*" in the window title.

* : Not yet compiled
 No marking: Already compiled



(3) The program executed after compile is not displayed on GX Developer.

REMARK

In the compiled sequence program, devices are assigned to labels in accordance with the Auto device setting.

The Auto device setting defaults to the following device ranges.

- 1) Word device : D6144 to D12287
- 2) Bit device : M4096 to M8191
- 3) Timer : T64 to T2047
- 4) Counter : C512 to C1023

The devices assigned to the labels are used in order, starting with the last numbers (D12287, M8191, T2047, C1023).

The following is the example of a program executed after compile.

(a) Sequence program

This ladder example stores 100 into D400 when X0 turns on as the value of D400 exceeds 4000.

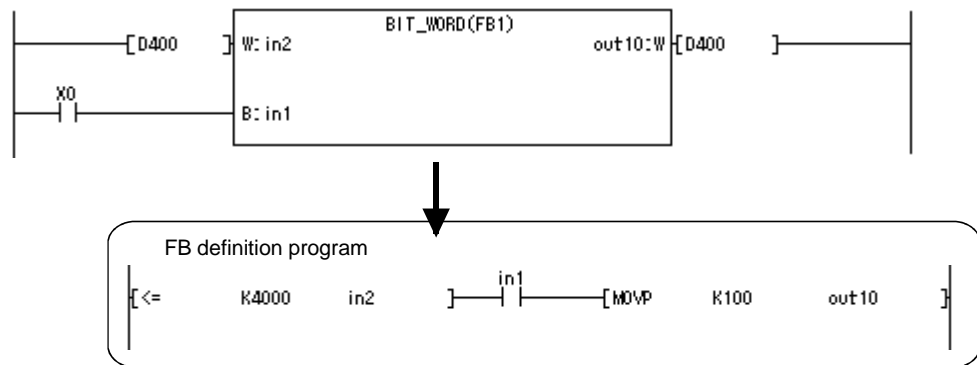

(b) Program executed after compile

Label	Assigned Device
in1	M8191
in2	D12287
out10	D12286

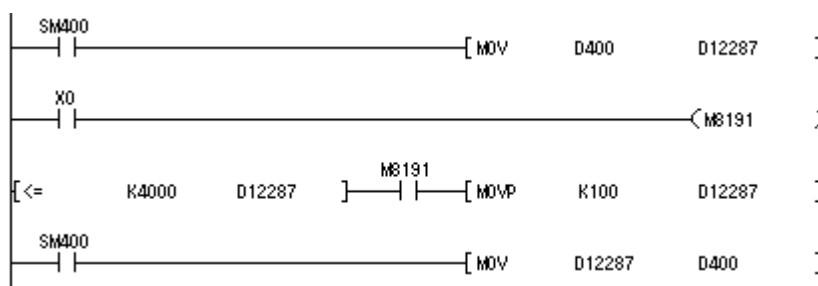

The contact X1 in the input ladder section and the devices D400 in the input and output ladder sections cannot be replaced directly by the labels in1, in2 and out10 in the FB definition program.

- The contact X1 is connected to the coil of the device M8191 assigned to in1.
- The device D400 in the input ladder section always transfers data to the device D12287 assigned to in2.
- The device D12286 assigned to out11 always transfers data to the device D400 in the output ladder section.

Since D12286/D12287 in this executed program are undefined at the startup of the PLC CPU, D400 changes to an indefinite value in the output ladder section if D400 in the input ladder section is less than 4000.

To avoid such a state, connect the same labels and set the variable type as I/O variables. Setting the variable type as the I/O variables connects the same devices to the input and output ladder sections.

The following is the program example where the above remedy has been taken.

(a) Sequence program

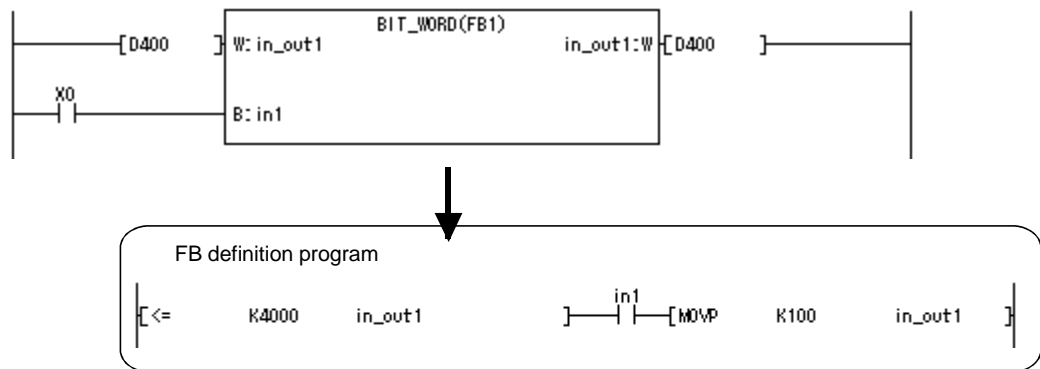

(b) Program executed after compile

Label	Assigned Device
in1	M8191
in _ out 10	D12287

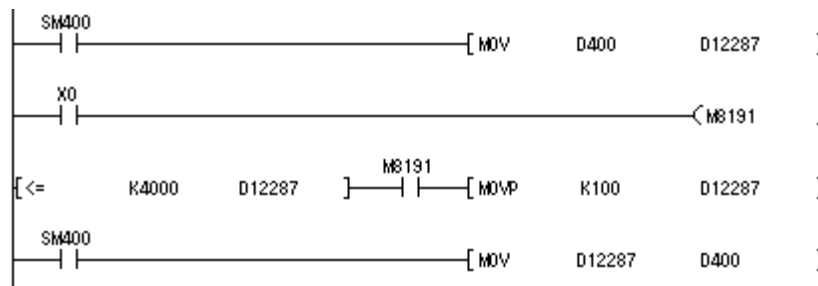

3.9 Writing the Converted Sequence Program to the PLC CPU (Write to PLC)

[Setting Purpose]

Write the converted sequence program to the PLC CPU.

[Operation Procedure]

Choose [Online] → [Write to PLC] or click .

REMARK

This manual does not detail the operations for writing to PLC.

For details of the operations for writing to PLC, refer to the GX Developer Version 7 Operating Manual given in the related manuals.

[Setting Procedure]

- (1) Set the access target in Transfer setup.
- (2) Display the Write to PLC dialog box.
- (3) Turn on and choose the check box of the data name which will be written to the PLC.

To select the parameters and all programs of the project, click the **Param+Prog** button.

- (4) Click the **Execute** button.

When the PLC CPU is in the RUN mode, the "After STOP remotely, is the PLC writing executed." dialog box appears. Click the **Yes** button.

At this time, the peripheral side and PLC CPU side parameters are checked. Write is stopped if a parameter check results in a mismatch.

If the data of the same name exists at the write destination, the overwrite confirmation dialog box appears. Clicking the **Yes all** button enables batch write to PLC.

When write to PLC is finished, the "PLC state is STOP. Is remote-RUN executed?" dialog box appears. Click the **Yes** button.

POINT

- (1) For the Q or QnA, integrated statements are written to the PLC CPU together with the programs.
Peripheral statements are not written to the PLC CPU. In this case, the statement/note merge option has the function to merge statements/notes with those in the personal computer when read from PLC is performed.
When the program has been read from the PLC CPU without use of this function, be careful not to overwrite the old program accidentally to save a program having no statements/notes.
- (2) The FB of the sequence program including the FB cannot be displayed if read from PLC is performed to read the program from the PLC CPU. GX Developer displays the sequence program that has been compiled. Hence, carefully store the program that has not yet been compiled since it is needed to correct the FB.

3.10 Monitoring and Testing the Sequence Program

3.10.1 Monitoring the sequence program

[Setting Purpose]

Monitor the sequence program that has been written to the PLC CPU to check the operating status of the PLC CPU.

The FB pasted to the sequence program can be monitored like contacts and coils. The program in the FB can also be monitored like the sequence program.

[Operation Procedure]

- When monitoring

Choose [Online] → [Monitor] → [Monitor mode] or click  ([F3]).

- When stopping monitoring

Choose [Online] → [Monitor] → [Stop monitor] or click  ([Alt] + [F3]).

- When resuming monitoring

Choose [Online] → [Monitor] → [Start monitor] or click  ([F3]).

[Window]

The following explains the example where the FB pasted to the sequence program and the program in the FB are monitored.

(1) The sequence program is displayed on the following monitor window.

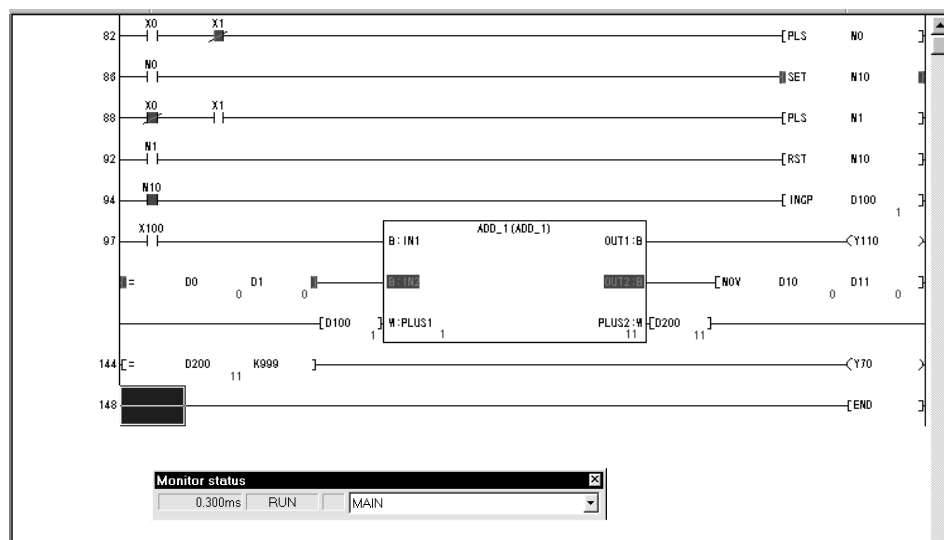

The ladder block that includes the FB in the sequence program is displayed on the monitor screen as described below.

(a) For input variable (BOOL)

1) When the condition is ON, the label of the input variable is highlighted.

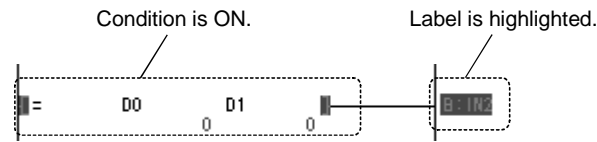

2) When the condition is OFF, the label of the input variable is not highlighted.

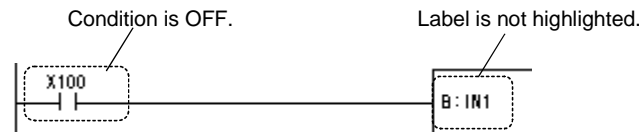

(b) For input variable (INT/DINT/REAL)

The numeric value stored under the label is displayed.

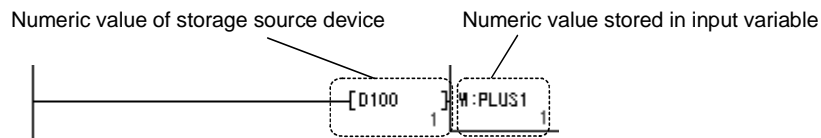

(c) For output variable (BOOL)

1) When the output variable is ON, the label is highlighted.

ON indication of output variable

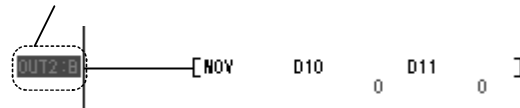

2) When the output variable is OFF, the label is not highlighted.

OFF indication of output variable

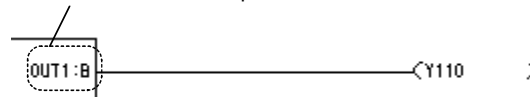

(b) For output variable (INT/DINT/REAL)

The numeric value stored under the label is displayed.

Numeric value stored in output variable

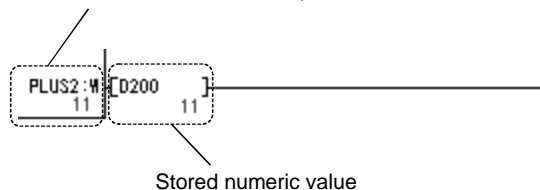

(2) When monitoring the FB program, double-click the FB on the sequence program to display the FB window. Then, execute monitoring on the displayed FB window.

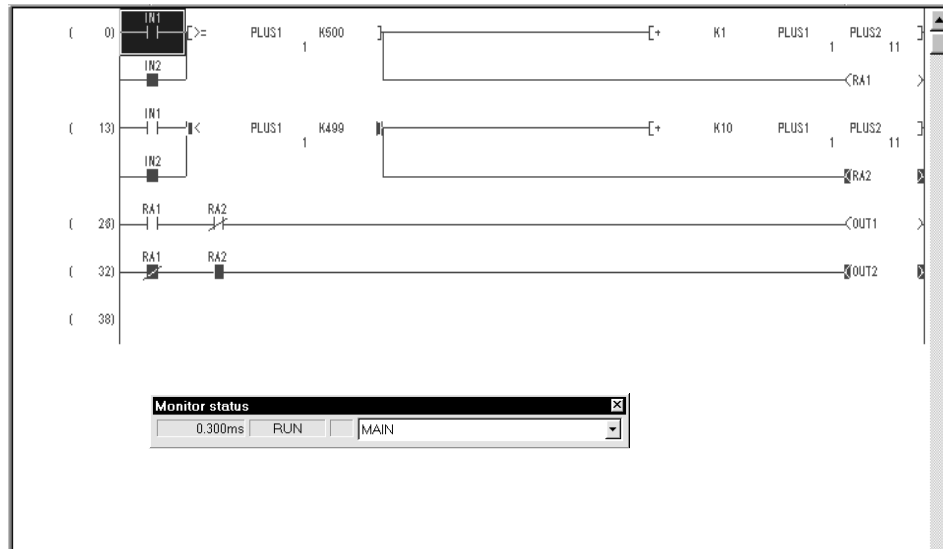

The following dialog box appears if the FB definition window or FB variable setting window has already been displayed.

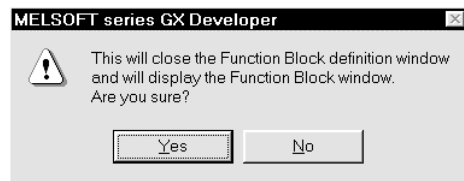

Clicking the **Yes** button closes the FB definition window or FB variable setting window and displays the FB window.

3.10.2 Testing the sequence program (Device test)

[Setting Purpose]

Forcibly turn ON/OFF the bit device of the PLC CPU or change the current value of the word device to check the created sequence program.

The FB pasted to the sequence program can be device-tested like the contacts and coils.

The program in the FB can also be device-tested like the sequence program.

[Operation Procedure]

Choose [Online] → [Debug] → [Device test] or click  ([Alt] + [1]).

[Dialog Box]

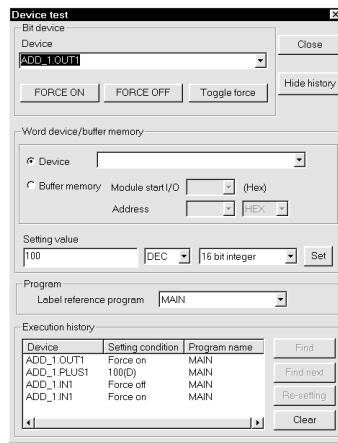

[Setting Procedure]

The following example explains the device test conducted on the FB pasted to the sequence program.

(1) Choose the target label of the FB to be device-tested.

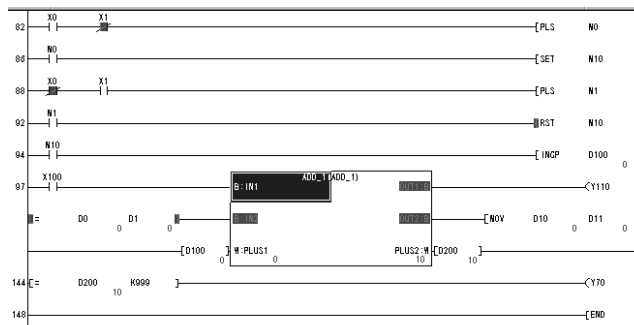

(2) If you choose [Device test], the device name (ADD_1.IN1) selected in the Device field has already been entered.

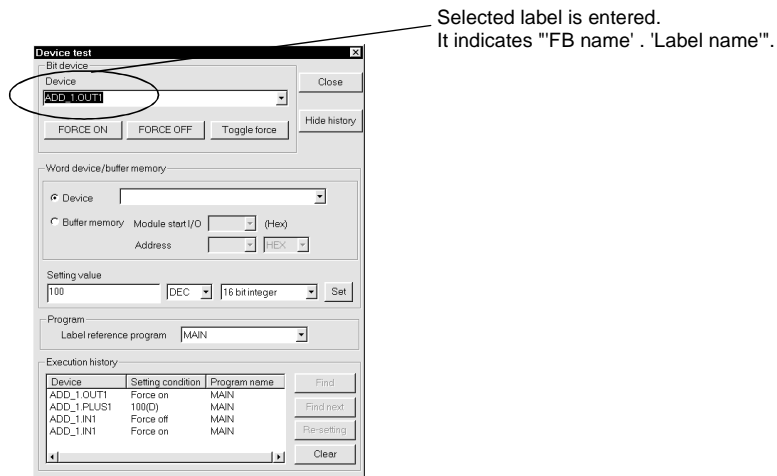

- (a) When the device type of the selected label is the bit, the label is entered into the Device field of Bit device.
- (b) When the device type is the INT/DINT/REAL, the label is entered into the Device field of Word device/buffer memory.

(3) Conduct the device test on the selected label.

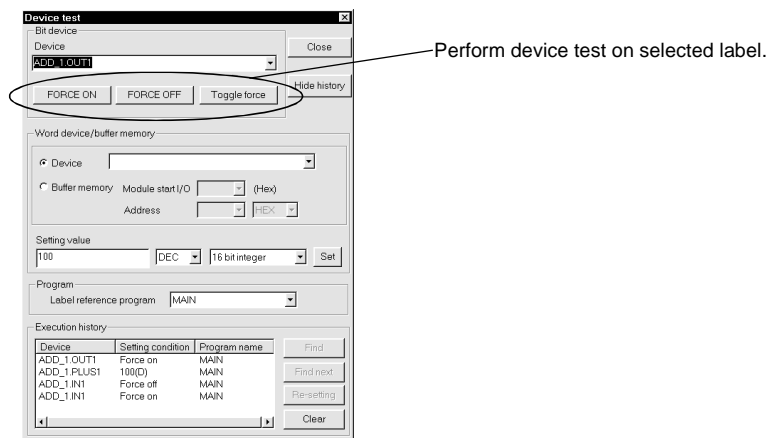

(4) The device test of the label is completed.

(5) When device-testing another label, enter the label directly into the Device field. Type "FB name" . "Label name" in the Device field.

POINT

Holding down the **Shift** key and double-clicking the label of the FB in the sequence program enables forced ON/OFF if the device type of the target label is the bit.

The device test dialog box appears if the device type of the target label is the INT/DINT/REAL.

3.11 Correcting the FB

[Setting Purpose]

Correct the FB program if the FB of the monitored/tested sequence program does not run as designed.

POINT
<p>(1) The FB of the sequence program including the FB cannot be displayed if read from PLC is performed to read the program from the PLC CPU. GX Developer displays the sequence program that has been compiled. Hence, carefully store the program that has not yet been compiled since it is needed to correct the FB.</p> <p>(2) Correct the FB program on the FB definition window. The program cannot be corrected on the FB window.</p> <p>(3) Note that if multiple pieces of the same FB definition have been pasted to the sequence program, correction to the FB definition program is reflected on all FBs.</p>

[Setting Procedure]

- (1) On the FB tab, double-click and choose the FB definition to be corrected.
- (2) As the FB definition window appears, correct the program.
If the FB window has already been displayed, the following dialog box appears.

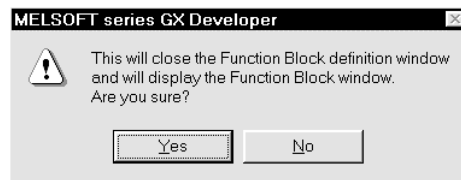

Clicking the **Yes** button closes the FB window and displays the FB definition window or FB variable setting window.

- (3) After completion of program correction, compile the FB definition.
If you do not execute compile, the correction is not reflected on the FB pasted to the sequence program.
- (4) Compile the sequence program where the corrected FB definition has been pasted.
If you do not execute compile, the correction made to the FB is not reflected on the sequence program.

3.12 Making Online Program Correction to the Sequence Program

[Setting Purpose]

Write the corrected sequence program to the PLC CPU that is in the RUN status.

POINT

Online program correction cannot be made if compile has been executed after correction of the FB definition.
--

In this case, choose [Online] → [Write to PLC] to write the program to the PLC CPU.

[Operation Procedure]

Choose [Convert] → [Convert(Online change)] or press **Shift** + **F4**.

4 UTILIZING THE EXISTING FB TO CREATE SEQUENCE PROGRAM

This chapter describes the operations for utilizing the created FB to create a sequence program.

The operation procedures in Section 4.1.1 and Sections 4.5 to 4.9 are the same as those in Section 3.1 and Sections 3.5 to 3.9. For explanations, refer to the corresponding sections of Chapter 3.

4.1 Creating Project for FB

4.1.1 Creating a new project

[Setting Purpose]

Set the PLC series, PLC type and Project name necessary to create a new project for the FB.

Refer to Section 3.1 for the explanation of the operation procedure.

4.1.2 Reading the existing project

[Setting Purpose]

Read the saved project to add the FB to the existing project.

[Operation Procedure]

Choose [Project] → [Open project] or click  ([Ctrl] + [O]).

[Dialog Box]

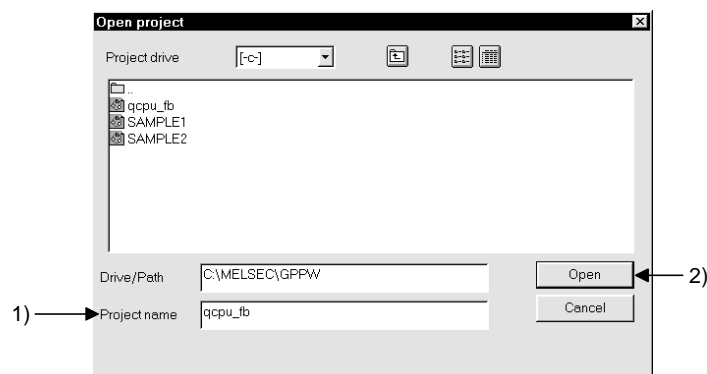

[Description]

1) Project name

Click the object project and set the project name.

2) button

After you finished the setting, click this button to read the project.

4.2 Utilizing the Existing FB Definition (Copy)

There are the following two ways to utilize the existing FB definition.

- (1) Utilizing the existing FB definition from another project (refer to Section 4.2.1)
- (2) Utilizing the existing FB definition within the same project (refer to Section 4.2.2)

These utilization methods will be described in the following sections.

4.2.1 Utilizing the existing FB definition from another project

[Setting Purpose]

Copy the FB definition created in another project to utilize it.

[Operation Procedure]

Choose [Project] → [Copy].

[Dialog Box]

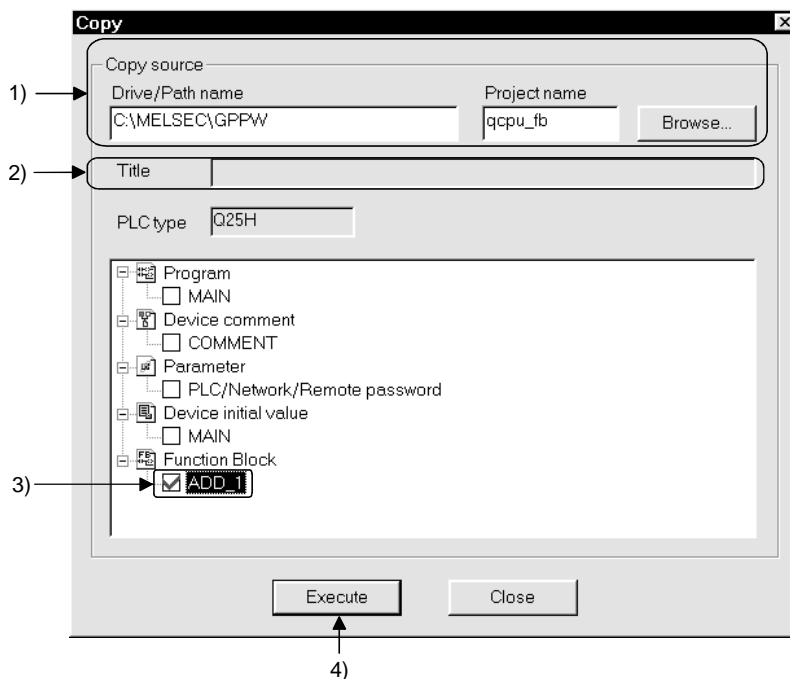

[Description]

- 1) Drive/Path name, Project name
From the **Browse** button, set the project having the FB definition you want to copy.
- 2) PLC type
The PLC type of the copy source project is displayed.
- 3) Copy source FB definition
Choose the FB definition you want to copy.
- 4) **Execute** button
Click this button to execute copy.

[Setting Procedure]

- (1) By clicking the button on the copy dialog box, the FB definition having the same name as that of the copy source is created in the project.
- (2) If the FB definition having the same name as that of the copy source already exists in the copy destination, the following dialog box appears to indicate that copy has been stopped.



To execute copy, change the FB definition name of the copy destination to another name and execute copy again.

Changing the FB definition name also changes the FB definition name of the FB pasted to the sequence program.

Refer to Section 4.3 for changing the FB definition name.

4.2.2 Utilizing the existing FB definition within the same project

[Setting Purpose]

Copy the FB definition already created in the same project to utilize it.

[Operation Procedure]

- Click the right button of the mouse on the <<Function Block>> tab and choose → [Copy].
- Choose [Project] → [Edit Data] → [Copy].
- Click the right button of the mouse on the <<Project>> tab and choose → [Copy].

[Dialog Box]

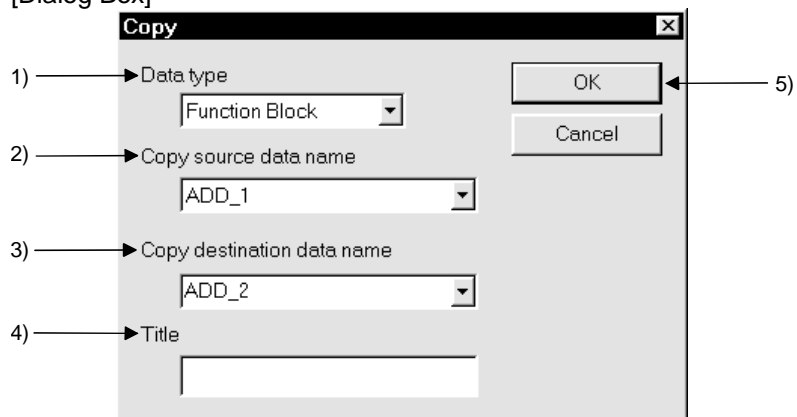

[Description]

1) Data type

Choose Function block.

When you choose the FB definition of the copy source and open the Copy dialog box, Function block has already been selected from the beginning.

2) Copy source data name

Set the data name (FB definition name) you want to copy.

When you choose the FB definition of the copy source and open Copy dialog box, the data name has already been set from the beginning.

Alternatively, as the list box displays the FB definition names already created, choose the object FB definition name from that list.

3) Copy destination data name

Set the data name (FB definition name) of the copy destination.

The list box displays the FB definition names already created. You can set the data name by choosing the FB definition name from that list and correct part of that name. Set the data name within eight characters.

• Usable characters

Alphanumeric characters, _, ^, \$, , ~ (tilde), !, #, %, &, (), -, { }, @, * (apostrophe), ' (single quotation)

• Unusable characters

Any of " = | : ; , \ [] + * ? < > . / will result in an error.

4) Title

Set the title to be set to the project within 32 characters.

5) button

Click this button when the setting is finished.

[Setting Procedure]

- (1) Clicking the button on the copy dialog box displays the following dialog box.

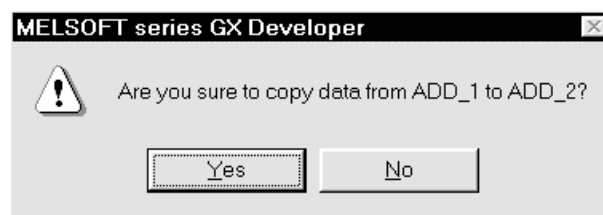

Click the button to start copy.

- (2) If the FB definition name of the copy destination already exists, the following dialog box appears to indicate that copy has been stopped.



4.3 Changing the FB Definition Name

[Setting Purpose]

Set a new name when you want to change the name of the FB definition copied from another project.

[Operation Procedure]

- Click the right button of the mouse on the <<Function Block>> tab and choose → [Rename].
- Choose [Project] → [Edit Data] → [Rename].
- Click the right button of the mouse on the <Project> tab and choose → [Rename].

[Dialog Box]

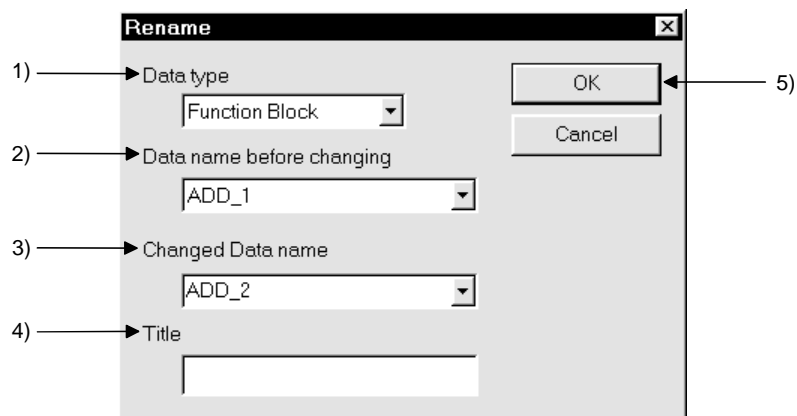

[Description]

1) Data type

Choose Function block.

When you choose the object FB definition and open the Rename dialog box, Function block has already been selected from the beginning.

2) Data name before changing

Set the data name (FB definition name) you want to change.

When you choose the object FB definition and open the Rename dialog box, the data name has already been set from the beginning.

Alternatively, as the list box displays the FB definition names already created, choose the object FB definition name from that list.

3) Change Data name

Set a new data name (FB definition name).

The list box displays the FB definition names already created. You can set the data name by choosing the FB definition name from that list and correct part of that name. Set the data name within eight characters.

- Usable characters

Alphanumeric characters, _, ^, \$, , ~ (tilde), !, #, %, &, (), -, { }, @, * (apostrophe), ' (single quotation)

- Unusable characters

Any of " = | : ; , \ [] + * ? < > . / will result in an error.

4) Title

Set the title to be set to the project within 32 characters.

5) button

Click this button when the setting is finished.

4.4 Correcting the Program Body or FB Variables of the Utilized FB Definition

[Setting Purpose]

Correct the utilized FB definition to be the program that meets its purpose.

[Setting Procedure]

- (1) Double-click the utilized FB to display the FB definition window or FB variable setting window.

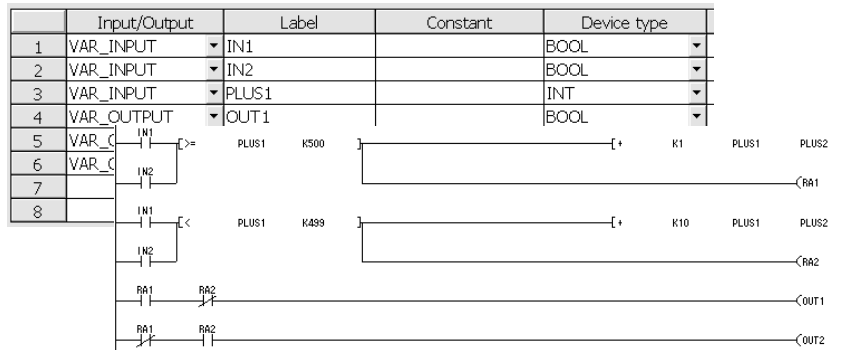

- (2) Correct the program on the FB definition window.

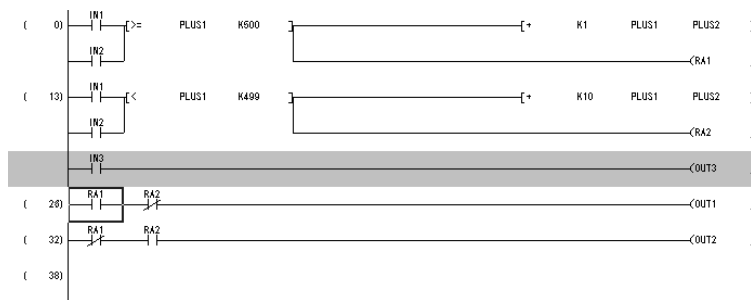

- (3) When you have corrected, added and/or deleted the labels, edit the labels on the FB variable setting window.

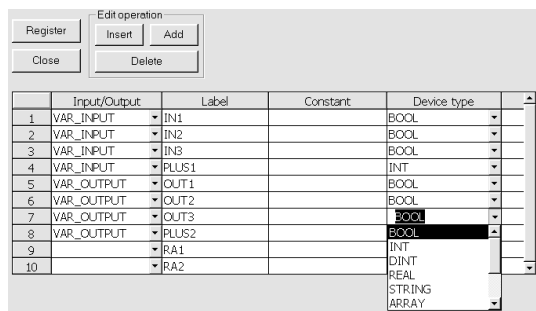

4.5 Converting the FB Definition (Compile)

[Setting Purpose]

Convert the corrected FB definition for use in the sequence program.

Refer to Section 3.5 for the explanation of the operation procedure.

4.6 Pasting the Converted FB to the Sequence Program (FB Utilization)

[Setting Purpose]

Paste the FB to the sequence program being created to enable the function block.

Refer to Section 3.6 for the explanation of the operation procedure.

4.7 Creating the Sequence Program

[Setting Purpose]

Create an input ladder section and an output ladder section for the FB pasted to the sequence program to complete the sequence program.

Refer to Section 3.7 for the explanation of the operation procedure.

4.8 Converting the Sequence Program into the Program to Be Executed on the PLC CPU (Compile)

[Setting Purpose]

The sequence program where the FB has been pasted cannot be executed as-is on the PLC CPU. Perform compile operation to convert it into the program to be executed.

Refer to Section 3.8 for the explanation of the operation procedure.

4.9 Writing the Converted Sequence Program to the PLC CPU (Write to PLC)

[Setting Purpose]

Write the converted sequence program to the PLC CPU.

Refer to Section 3.9 for the explanation of the operation procedure.

5 DELETING UNNECESSARY FB DEFINITION FROM THE PROJECT

[Setting Purpose]

Delete the FB definition that has become unnecessary due to project modifications.

[Operation Procedure]

- Click the right button of the mouse on the <<FB>> tab and choose → [Delete].
- Choose [Project] → [Edit Data] → [Delete].
- Click the right button of the mouse on the <<Project>> tab and choose → [Delete].

[Dialog Box]

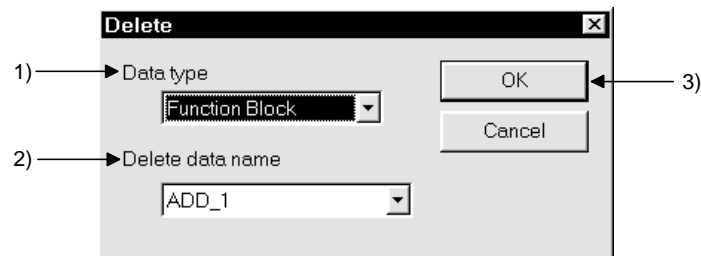

[Description]

1) Data type

Choose Function block.

When you choose the object FB and open the Delete dialog box, Function block has already been selected from the beginning.

2) Delete data name

Set the data name (FB definition name) to be deleted.

When you choose the object FB and open the Delete dialog box, the data name has already been set from the beginning.

Alternatively, as the list box displays the FB definition names already created, choose the object FB definition name from that list.

3) button

Click this button when the setting is finished.

[Setting Procedure]

- (1) Setting the object FB definition name and clicking the button displays the following message.

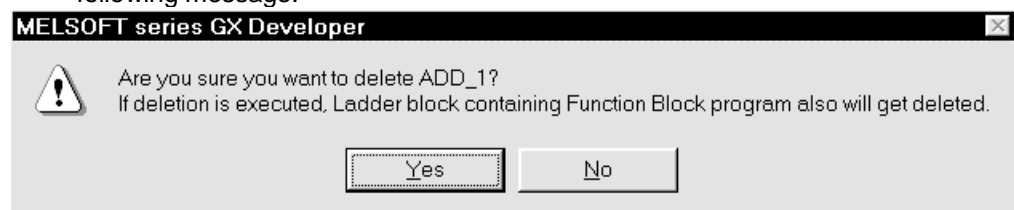

- (2) Click the button to delete the FB definition.

POINT

- (1) Deleting the FB definition also deletes the ladder block that includes the deleted FB definition (FB) from the sequence program.
Before executing delete, it is recommended to confirm by making character string search that the FB definition to be deleted is not being used in the sequence program. (Refer to Section 3.7.3.)
- (2) When deletion of the FB definition is to be executed, the following message appears to indicate that conversion has been stopped if the sequence program that includes the FB definition (FB) to be deleted is not yet converted.

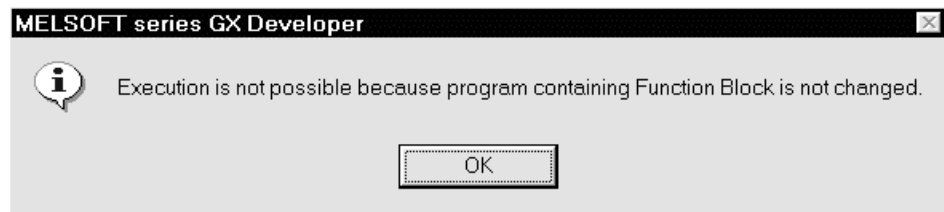

Before executing delete, convert the sequence program or delete the ladder block that includes the FB first from the sequence program.

6 COMBINING MULTIPLE PROGRAMS INTO ONE

6.1 Combining Sequence Programs into One

[Setting Purpose]

When multiple sequence programs including FBs exist, combine the sequence programs into one.

[Setting Procedure]

The sequence programs including FBs cannot be combined into one by the operation performed using [Merge data] in the [Tools] menu. Hence, perform copy and paste operation between the sequence programs in the same project to combine them into one. The procedure will be described using the following two programs as an example.

(a) Copy destination program: MAIN

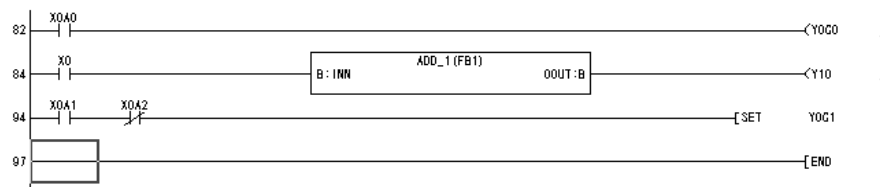

(b) Copy source program: MAIN1

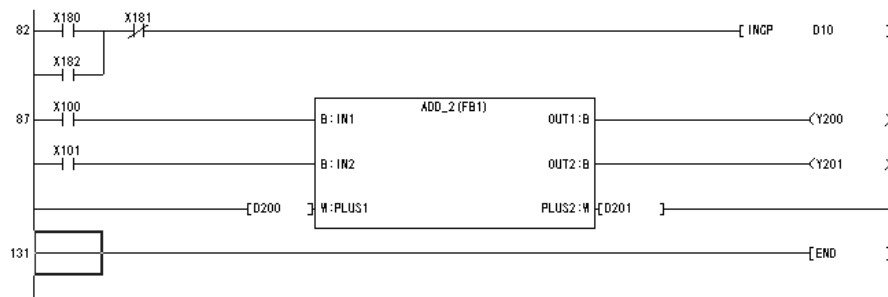

(1) Select and copy the area from step 0 to the necessary step of the copy source sequence program.

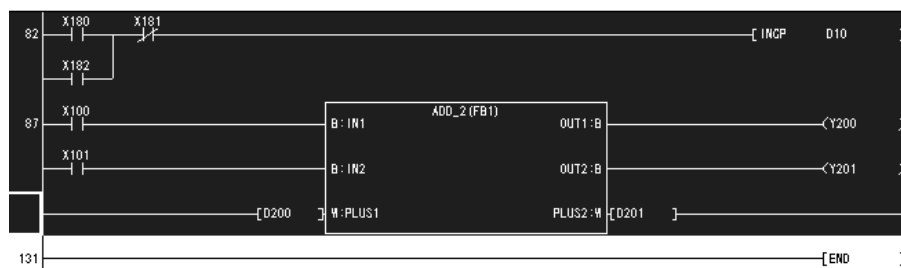

6

(2) Paste the copied sequence program to the step of the copy destination sequence program where you want to make insertion.

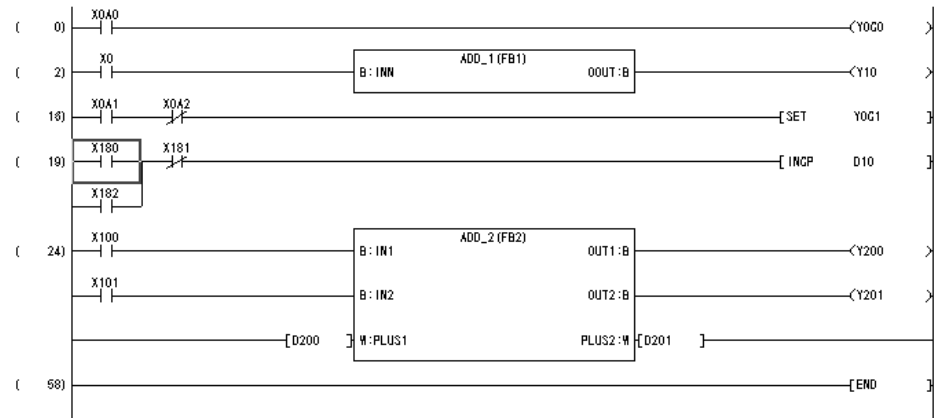

(3) Convert and save the sequence program.

POINT

Copy and paste operation cannot be performed between the sequence program of one project and that of the other project.

In this case, perform the following operation.

(1) Choose [Project] → [Copy] to copy the sequence program and FB definition of the other project.

At this time, copy cannot be executed if the PLC type of the copy source project differs from that of the copy destination project.

In this case, change the PLC type of the copy source project to that of the copy destination project and save it as another project.

(2) Perform copy and paste operation between the sequence programs of the same project.

6.2 Combining Comments into One (Data Joint)

[Setting Purpose]

Combine the comments of multiple sequence programs into one.

[Operation Procedure]

Choose [Tools] → [Merge data].

REMARK

For details of the operation, refer to "Merge data" of the GX Developer Version 7 Operating Manual.

POINT

- Comments not saved in the personal computer cannot be combined.
- Merge data cannot combine the sequence programs that include FBs.

7 VERIFYING THE PROJECTS

[Setting Purpose]

Verify data between the projects of the same PLC type.

[Operation Procedure]

Choose [Project] → [Verify].

REMARK

For details of the operation, refer to "Verifying Data in Projects" of the GX Developer Version 7 Operating Manual.

Executing project verify displays the verify results of the following items.

- (1) Parameters
- (2) Labels + FB programs
- (3) Actual programs

The following are the display examples of verify results.

(a) Verify results: When the results are OK

```
[Project verify: Real program]
Verify source
Project name -C:\MELSEC\GPPW\qcpu_fb
Data name -MAIN
Verify destination
Project name -C:\MELSEC\GPPW\qcpu_fb2
Data name -MAIN

<Memory>                                <File>
Step  Instruction                          Step  Instruction

No unmatched areas.
```

(b) Verify results: When the results are not good

```
[Project verify: Label+FB program]
Verify source
Project name -C:\MELSEC\GPPW\qcpu_fb
Data name -MAIN
Verify destination
Project name -C:\MELSEC\GPPW\qcpu_fb3
Data name -MAIN

<Memory>                                <File>
Step  Instruction                          Step  Instruction
-----
172  OUT Y70                               (  55) AND M1000
173  END                                    (  56) ANI M2001

2 items unmatched.
```

POINT

(1) Verified data are as follows.

- Parameters
 - Sequence programs where FBs have been pasted
 - Actual programs available by compiling the above sequence programs (programs written to the PLC CPU)
- FB definitions (program bodies, FB variables) are not verified.

(2) If sequence programs not yet compiled are verified, the following message appears to indicate that verify has been stopped.

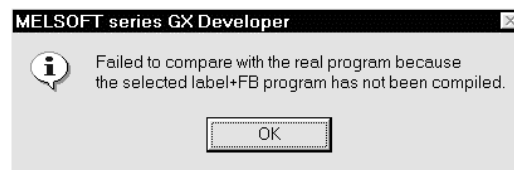

(3) Multiple data can be selected as shown below for the verify source and verify destination. Verify is performed between the data of the same name.

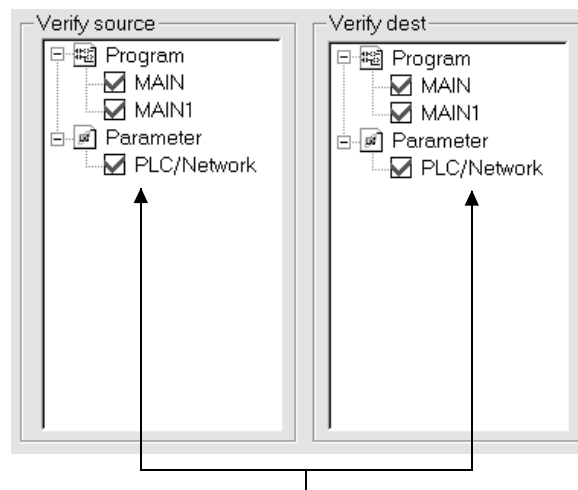

Choose the data names by turn on their check boxes.

(4) For programs, verify can be made between sequence programs that include FBs.

Verify is disabled if the programs specified are not the sequence programs that include FBs.

8 PRINTING

This chapter describes the operation methods for printing the sequence program including FB and printing the FB definition.

For other printing methods, refer to the GX Developer Version 7 Operating Manual given in the related manuals.

8.1 Printing the Sequence Program Including FB

[Setting Purpose]

Print the sequence program that includes the FB.

[Operation Procedure]

Choose [Project] → [Print] or click  (**Ctrl** + **P**).

[Dialog Box]

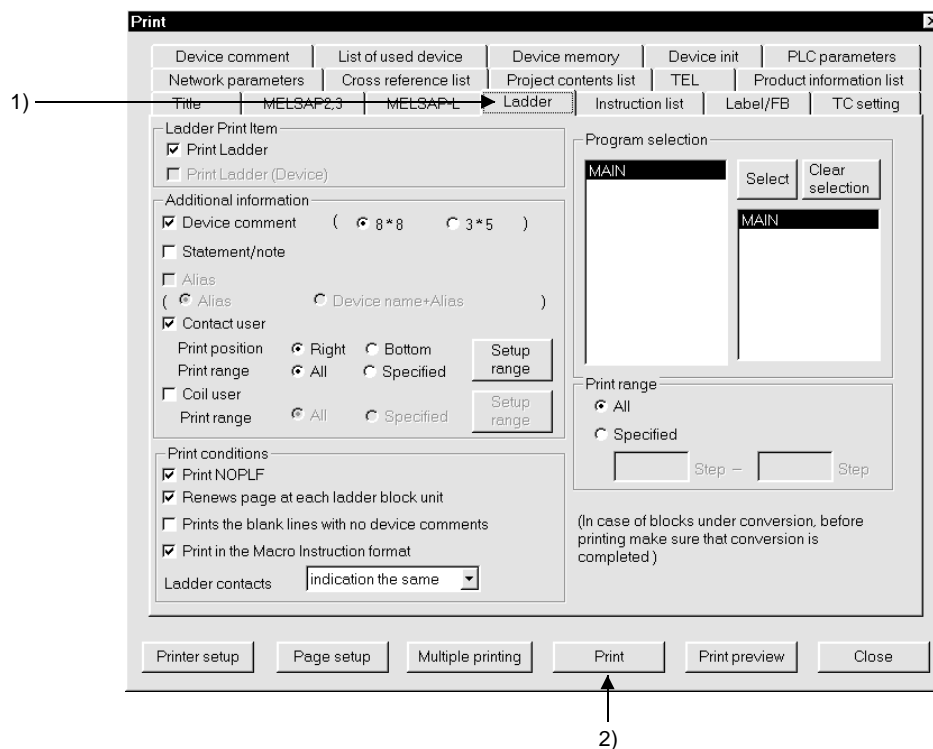

[Description]

- 1) <<Ladder>> tab
Click this tab to switch to the print detail setting screen.
- 2) **Print** button
Click this button to print the sequence program.

[Setting Procedure]

(1) After setting the necessary information for printing, click the [Print] button to start printing.

(Print example)

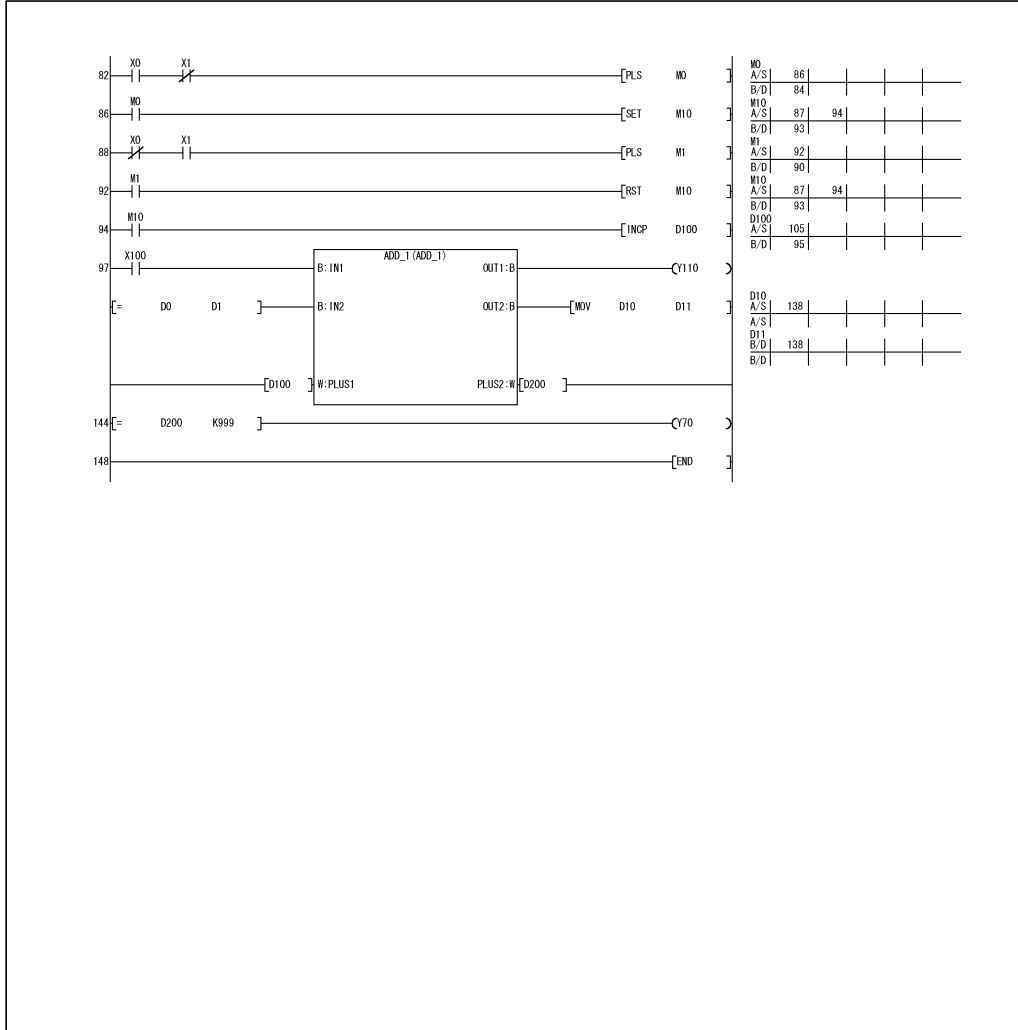

REMARK

The following items cannot be printed when the FB was used to create the program.

- MELSAP2, 3
- MELSAP-L
- List printing

8.2 Printing the FB Definition

[Setting Purpose]

Print the FB definition program and/or FB variables of the FB definition.

[Operation Procedure]

Choose [Project] → [Print] or click  (**Ctrl** + **P**).

[Dialog Box]

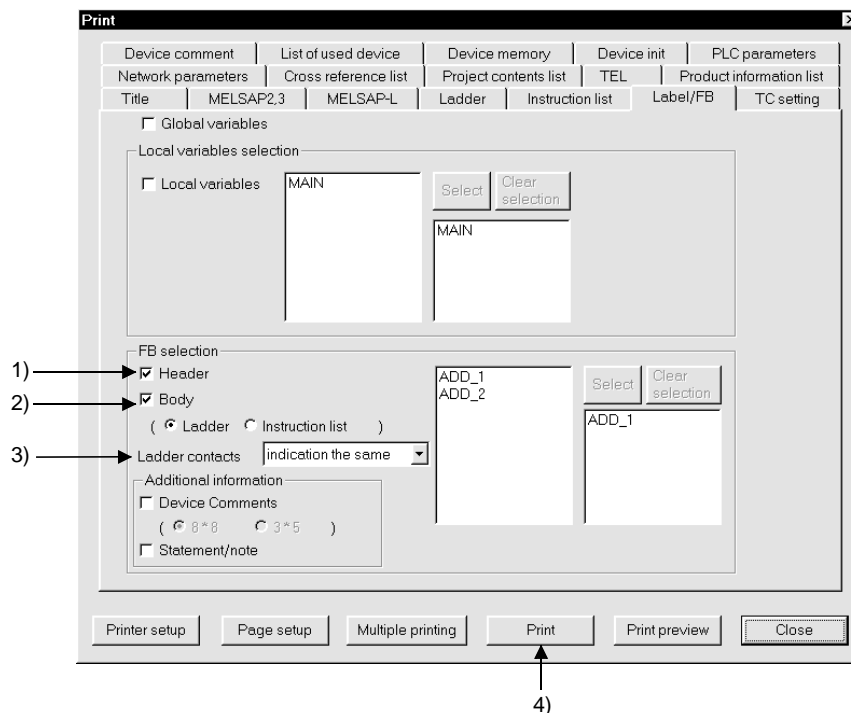

[Description]

1) Header

Turning on the check box prints the FB variables.

2) Body

Turning on the check box prints the FB definition program.

Choose the program format from Ladder or List. It defaults to Ladder.

3) Additional information

Select whether the FB definition program to be printed is annotated with device comments and/or statements/notes.

Turn on the corresponding check box to annotate the program.

4) **Print** button

Click this button to print the sequence program.

[Setting Procedure]

(1) Choose the FB definition to be printed.

Click and highlight the FB definition to be printed from the list of the FB definitions registered to the project, and then click the [Select] button.

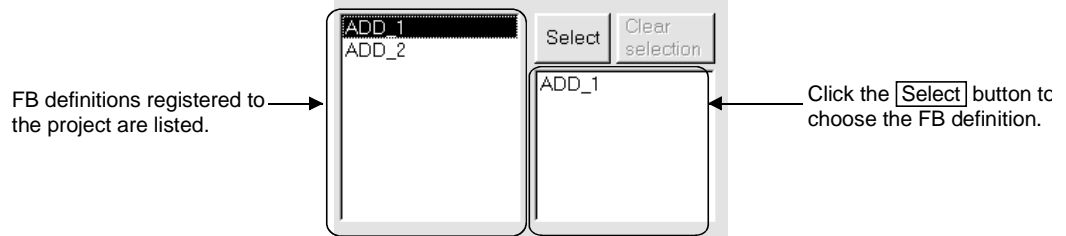

(2) Select the item to be printed (Header, Body) and click the [Print] button to start printing.

(Print example: FB variables)

Function block

Header Function block name : ADD_1 Title :

Label	Device/Constant	Device kind	Input/Output	Comment
IN1		BOOL	VAR_INPUT	
IN2		BOOL	VAR_INPUT	
PLUS1		INT	VAR_INPUT	
OUT1		BOOL	VAR_OUTPUT	
OUT2		BOOL	VAR_OUTPUT	
PLUS2		INT	VAR_OUTPUT	
RA1		BOOL	VAR_OUTPUT	
RA2		BOOL	VAR_OUTPUT	

(Print example: Program body)

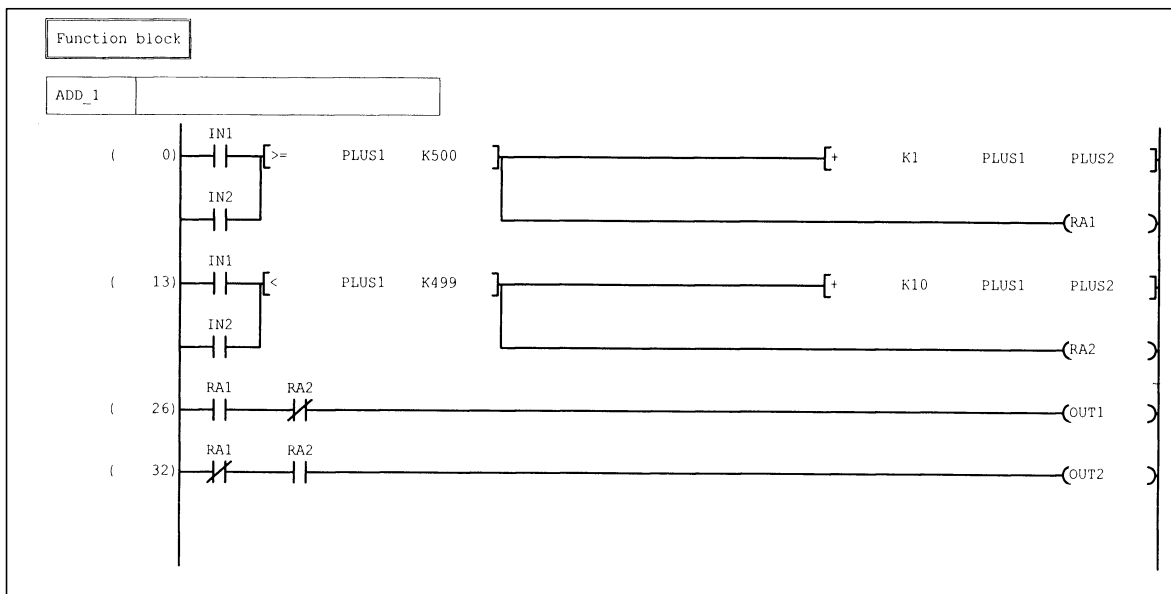

APPENDICES

Appendix 1 Character Strings Unusable as Labels and FB Names

The following character strings are unusable as labels and FB names for function block programming.

The string of device name, sequence instruction, SFC instruction, application instruction can not be used as label.

An error may occurred during registering or at compile time when any of the following strings are used

The strings which can not be used in label programming	
A	A,ACJ,ADD,ANB,AND,ANDF,ANDN,ANDP,ANI,ANY,ANY_BIT,ANY_DATE,ANY_DERIVED,ANY_ELEMENTARY,ANY_INT,ANY_MAGNITUDE,ANY_NUM,ANY_REAL,ANY_SIMPLE,ANY_STRING,ARRAY
B	B,BCD(P),BEND,BIN(P),BKBCD(P),BKBIN(P),BL,BLOCK,BMOV(P),BOOL,BOOL_TO_BYTE(DINT,DWORD,INT,REAL,SINT,UDINT,UINT,USINT,WORD),BYTE(DINT,DWORD,INT,REAL,SINT,TIME,UDINT,UINT,USINT,WORD)_TO_STRING,BYTE_TO_BOOL(DINT,DWORD,INT,REAL,SINT,UDINT,UINT,USINT,WORD),B_BCD_TO_DINT(INT,SINT),BXCH(P),BYTE
C	C,CAL,CALC,CALCN,CJ,CML(P)
D	D,DBCD(P),DBIN(P),DBL(P),DCML(P),DDEC(P),DEC(P),DELTA(P),DFLT(P),DGBIN(P),DGRY(P),DI,DINC(P),DINT,DINT(P),DINT_TO_BCD(BOOL,BYTE,DWORD,INT,REAL,SINT,TIME,UDINT,UINT,USINT,WORD),DIV,DMOD,DMOV(P),DNEG(P),DWORD,DWORD_TO_BOOL(BYTE,DINT,INT,REAL,SINT,UDINT,UINT,USINT,WORD),DX,DXCH(P),DY,D_BCD_TO_DINT(INT,SINT)
E	E,EGF,EGP,EI,EMOV(P),END,ENEG(P),EQ,EQ(GE,GT,LE,LIMIT,LT,MAX,MIN,NE,SEL)_STRING
F	F,FD,FEND,FF,FLT(P),FMOV(P),FX,FY
G	G,GBIN(P),GE,GOEND,GRY(P),GT
H	H
I	I,IMASK,INC(P),INT,INT(P),INT_TO_BOOL(BYTE,DINT,DWORD,REAL,SINT,UDINT,UINT,USINT,WORD),INV,IRET
J	J,JMP,JMPC,JMPCN
K	K
L	L,LD,LDF,LDI,LDN,LDP,LE,LED,LEDA,LEDB,LEDC,LEDR,LINT,LREAL,LT,LWORD
M	M,MC,MCR,MEF,MEP,MOD,MOV(P),MPP,MPS,MRD,MTR,MUL
N	N,NE,NEG(P),NOP,NOPLF,NOT
O	OR,ORB,ORF,ORI,ORN,ORP,OUT(H)
P	P,PAGE,PCHK,PLF,PLS,PLSY,PWM
Q	Q
R	R,RAMP,RCJ,READ,REAL,REAL_TO_BOOL(BYTE,DINT,DWORD,INT,SINT,UDINT,UINT,USINT,WORD),RECV,REQ,RET,RETC,RETCN,RFRP,RFS,ROTC,RST,RTOP

INDEX

- [A]
 Add button 3-12
 Auto device setting 3-13
 Automatic assignment..... 3-13
- [C]
 Command button..... 4-9
 Comment 3-12, 3-28
 Compile..... 3-14, 3-29
 Constant 3- 8, 3-11
- [D]
 Delete button 3-12
 Device test 3-36
 Device type..... 3-12
 BOOL 3-12
 DINT 3-12
 INT 3-12
 REAL..... 3-12
 STRING 3-12
- [D]
 FB 1- 1
 FB definition..... 1- 2
 FB definition name 1- 4
 FB definition program..... 1- 2
 FB definition window 1- 2
 FB name 1- 4
 FB window 1- 4
 FB section..... 1- 4
 FB tab 1- 2
 FB utilization 3-16
 FB variable..... 1-3
 FB variable setting window 1- 3
- [I]
 I/O variable 3- 8, 3-11
 Input ladder section..... 3-21
 Input variable 3- 8, 3-11
 Insert button..... 3-12
- [L]
 Label 3-11
- [M]
 Monitor 3-33
- [N]
 Note 3-28
- [O]
 Online program correction 3-39
 Output ladder section..... 3-21
 Output variable..... 3- 8, 3-11
- [P]
 Printing
 Printing the sequence program 8- 1
 Printing the FB definition 8- 3
 Program body..... 1- 2
 Project 3- 3
 Project tab 1- 4
- [R]
 Replace
 Change module start address 3-26
 Change open/close contact 3-26
 Replace character string..... 3-26
 Replace device 3-26
 Replace Instruction 3-26
 Replace statement/note type..... 3-26
- [S]
 Search
 Cross reference list 3-26
 Find character string 3-26
 Find contact or coil 3-26
 Find device 3-26
 Find instruction 3-26
 Find step no..... 3-26
 List of used device 3-26
 Sequence program window 1- 3, 3-26
 Statement 3-28

[V]
Variable type..... 3-11

[W]
Write to PLC 3-32

Microsoft Windows, Microsoft Windows NT are registered trademarks of Microsoft Corporation in the United States and other countries.

Pentium is registered trademark of Intel Corporation in the United States and other countries.

Other company and product names herein are either trademarks or registered trademarks of their respective owners.

SPREAD

Copyright (C) 1998 FarPoint Technologies, Inc.

HEADQUARTERS

MITSUBISHI ELECTRIC EUROPE B.V. EUROPE
 German Branch
 Gothaer Straße 8
D-40880 Ratingen
 Phone: +49 (0) 21 02 / 486-0
 Fax: +49 (0) 21 02 / 4 86-1 12
 e mail: megfamail@meg.mee.com

MITSUBISHI ELECTRIC EUROPE B.V. FRANCE
 French Branch
 25, Boulevard des Bouvets
F-92741 Nanterre Cedex
 Phone: +33 1 55 68 55 68
 Fax: +33 1 49 01 07 25
 e mail: factory.automation@framee.com

MITSUBISHI ELECTRIC EUROPE B.V. ITALY
 Italian Branch
 Via Paracelso 12
I-20041 Agrate Brianza (MI)
 Phone: +39 039 6053 1
 Fax: +39 039 6053 312
 e mail: factory.automation@it.mee.com

MITSUBISHI ELECTRIC EUROPE B.V. SPAIN
 Spanish Branch
 Carretera de Rubí 76-80
E-08190 Sant Cugat del Vallés
 Phone: +34 9 3 / 565 3131
 Fax: +34 9 3 / 589 2948
 e mail: industrial@sp.mee.com

MITSUBISHI ELECTRIC EUROPE B.V. UK
 UK Branch
 Travellers Lane
GB-Hatfield Herts. AL10 8 XB
 Phone: +44 (0) 1707 / 27 61 00
 Fax: +44 (0) 1707 / 27 86 95

MITSUBISHI ELECTRIC CORPORATION JAPAN
 Office Tower "Z" 14 F
 8-12,1 chome, Harumi Chuo-Ku
Tokyo 104-6212
 Phone: +81 3 / 622 160 60
 Fax: +81 3 / 622 160 75

MITSUBISHI ELECTRIC AUTOMATION USA
 500 Corporate Woods Parkway
Vernon Hills, IL 60061
 Phone: +1 847 / 478 21 00
 Fax: +1 847 / 478 22 83

EUROPEAN REPRESENTATIVES

GEVA GmbH AUSTRIA
 Wiener Straße 89
A-2500 Baden
 Phone: +43 (0) 2252 / 85 55 20
 Fax: +43 (0) 2252 / 488 60
 e mail: office@geva.co.at

Getronics bv BELGIEN
 Control Systems
 Pontbeeklaan 43
B-1731 Asse-Zellik
 Telefon: +32 (0) 2 / 467 17 51
 Telefax: +32 (0) 2 / 467 17 45
 E-Mail: infoautomation@getronics.com

TELECON CO. BULGARIA
 4, A. Ljapchev Blvd.
BG-1756 Sofia
 Phone: +359 92 / 97 44 05 8
 Fax: +359 92 / 97 44 06 1
 e mail: —

INEA CR d.o.o. CROATIA
 Drvinje bb
HR-10000 Zagreb
 Phone: +385 (0) 1 / 366 71 40
 Fax: +385 (0) 1 / 366 71 40
 e mail: inea-cr@zg.tel.hr

AutoCont Control CZECHIA
 Systems s.r.o.
 Nemocnicni 12
CZ-702 00 Ostrava 2
 Phone: +420 (0) 69 / 615 21 11
 Fax: +420 (0) 69 / 615 21 12
 e mail: petr.pustovka@autocont.cz

louis poulsen DENMARK
 Geminivej 32
DK-2670 Greve
 Phone: +45 (0) 43 / 95 95 95
 Fax: +45 (0) 43 / 95 95 91
 e mail: lpia@lpmail.com

UTU Elektrotehnika AS ESTONIA
 Pärnu mnt.160i
EE-11317 Tallinn
 Phone: +372 6 / 51 72 80
 Fax: +372 6 / 51 72 88
 e mail: utu@utu.ee

Beijer Electronics OY FINLAND
 Elannontie 5
FIN-01510 Vantaa
 Phone: +358 (0) 9 / 615 20 11
 Fax: +358 (0) 9 / 615 20 500
 e mail: info@elc.beijer.fi

MITSUBISHI ELECTRIC IRELAND
 EUROPE B.V. – Irish Branch
 Westgate Business Park
IRL-Dublin 24
 Phone: +353 (0) 1 / 419 88 00
 Fax: +353 (0) 1 / 419 88 90
 e mail: sales.info@meuk.mee.com

EUROPEAN REPRESENTATIVES

Getronics bv NETHERLANDS
 Control Systems
 Donauweg 2B
NL-1043 AJ Amsterdam
 Phone: +31 (0) 20 / 587 68 30
 Fax: +31 (0) 20 / 587 68 39
 e mail: info.gia@getronics.com

Beijer Electronics A/S NORWAY
 Teglverksveien 1
N-3002 Drammen
 Phone: +47 (0) 32 / 24 30 00
 Fax: +47 (0) 32 / 84 85 77
 e mail: info@elc.beijer.no

MPL Technology SP. z.o.o POLAND
 ul. Wroclawska 53
PL-30011 Kraków
 Phone: +48 (0) 12 / 632 28 85
 Fax: +48 (0) 12 / 632 47 82
 e mail: mpl@krakow.ipl.net

Sirius Trading & Services srl ROMANIA
 Bd. Ghica nr. 112, Bl. 41, Sc.2, ap. 98
RO-72235 Bucuresti 2
 Phone: +40 (0) 1 / 210 55 11
 Fax: +40 (0) 1 / 210 55 11
 e mail: sirius_t_s@fx.ro

ACP AUTOCOMP a.s. SLOVAKIA
 Chalupkova 7
SK-81109 Bratislava
 Phone: +421 (0) 7 592 22 48
 Fax: +421 (0) 7 592 22 54
 e mail: acp.autocomp@nextra.sk

INEA d.o.o. SLOVENIA
 Ljubljanska 80
SI-1230 Domžale
 Phone: +386 (0) 1 / 721 80 00
 Fax: +386 (0) 1 / 724 16 72
 e mail: inea@ineasi

Beijer Electronics AB SWEDEN
 Box 325
S-20123 Malmö
 Phone: +46 (0) 40 / 35 86 00
 Fax: +46 (0) 40 / 93 23 01
 e mail: info@elc.beijer.se

ECONOTEC AG SWITZERLAND
 Postfach 282
CH-8309 Nürensdorf
 Phone: +41 (0) 1 / 838 48 11
 Fax: +41 (0) 1 / 838 48 12
 e mail: info@econotec.ch

GTS TURKEY
 Darülaceze Cad. No. 43A KAT: 2
TR-80270 Okmeydani-Istanbul
 Phone: +90 (0) 212 / 320 1640
 Fax: +90 (0) 212 / 320 1649
 e mail: gts@turk.net

MIDDLE EAST REPRESENTATIVE

TEXEL Electronics LTD. ISRAEL
 Rehov Hamerkava 19
IL-42160 Netanya
 Phone: +972 (0) 9 / 863 08 91
 Fax: +972 (0) 9 / 885 24 30
 e mail: texel_me@netvision.net.il

EURASIAN REPRESENTATIVES

MITSUBISHI ELECTRIC EUROPE B.V. RUSSIA
 Moscow Representative Office
 52 Kosmodamianskaya Nab., bld. 5
RUS-113054 Moskow
 Phone: +7 (0) 95 / 721 2070
 Fax: +7 (0) 95 / 721 2071
 e mail: info@mitsubishi-electric.ru

NPP Uralelektra RUSSIA
 Sverdlova 11A
RUS-620027 Ekaterinburg
 Phone: +7 34 32 / 53 27 45
 Fax: +7 34 32 / 53 24 61
 e mail: elektra@etel.ru

JV-CSC Automation UKRAINE
 15, Marina Raskovoyi St.
U-02002 Kiev
 Phone: +380 (44) / 238 83 16
 Fax: +380 (44) / 238 83 17
 e mail: mkl@csc-a.kiev.ua

AFRICAN REPRESENTATIVE

Circuit Breaker INDUSTRIES LTD. SOUTH AFRICA
 Private Bag 2016
ZAF-1600 Isando
 Phone: +2711 928 2000
 Fax: +2711 392 2354