

# FX<sub>2N</sub>

## FX<sub>2N</sub>-485-BD COMMUNICATION BOARD

### HARDWARE MANUAL

JY992D73401A

This manual contains text, diagrams and explanations which will guide the reader in the correct installation and operation of the FX<sub>2N</sub>-485-BD COMMUNICATION BOARD. It should be read and understood before attempting to install or use the unit. Further information can be found in the FX PROGRAMMING MANUAL, FX<sub>2N</sub> series hardware manuals and manual of FX COMMUNICATION USER'S MANUAL.

If in doubt at any stage during the installation of the FX<sub>2N</sub>-485-BD COMMUNICATION BOARD always consult a professional electrical engineer who is qualified and trained to the local and national standards.

## 1. INTRODUCTION

The communication board FX<sub>2N</sub>-485-BD for RS485 (hereinafter referred to as "485BD") can be connected to the base unit of the FX<sub>2N</sub> Series programmable controller to be used for the following applications.

### 1) Data transfer using no protocol

Data communication with diversified RS232C units including personal computers, bar code readers and printers can be performed via the RS485 (422) converter using the no protocol. In this application, data is sent or received using the data registers specified by the RS instruction. For the setting and program examples, refer to the FX Programming Manual and FX Communication User's Manual.

### 2) Data transfer using the dedicated protocol

Data transfer with RS485 (422) units can be performed on the 1:N basis using the dedicated protocol. For the contents of the dedicated protocol used in this application, refer to the FX Communication User's Manual.

### 3) Data transfer using the parallel link

Data transfer with an FX<sub>2N</sub> programmable controller can be performed on the 1:1 basis for 100 auxiliary relays and 10 data registers. For the setting and program examples, refer to the FX Communication User's Manual.

### 4) Data transfer using the N:N network

Data transfer with FX<sub>2N</sub> programmable controllers can be performed on the N:N basis. For the setting, the number of transferred data and program examples, refer to the FX Communication User's Manual.

## 1.1 External Dimensions

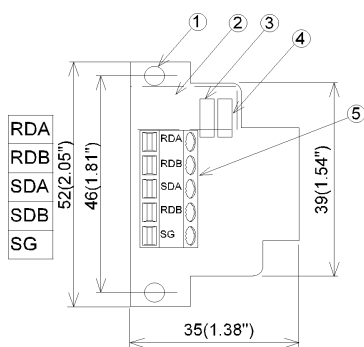

Dimensions : mm(inches)

Accessory : M3 self-tapping screw×2,  
Terminal resistor 330Ω×2, 110Ω×1

- ① Mounting holes (2Ø- 4.0(0.16"))
- ② Connector for programmable controller
- ③ SD LED: Flashes at high speed during sending.
- ④ RD LED: Flashes at high speed during receiving.
- ⑤ Terminals to connect RS485 unit The top face of this terminal block is higher than the top face of the panel cover of the programmable controller by approximately 7mm.

## 1.2 System Configuration

### 1.2.1 No Protocol or Dedicated Protocol

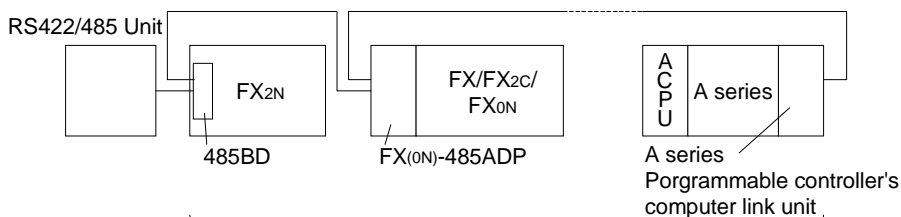

When using 485BD in the system, total extension distance is 50m. (No use : max. 500m)  
When using dedicated protocol, max.16 stations including A series programmable controller.

### 1.2.2 Parallel Link

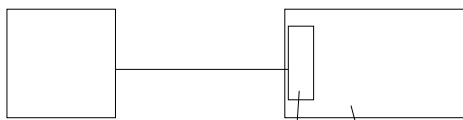

- ① FX2N+485BD
- ② FX2N+FX2N-CNV-BD  
+FX0N-485ADP
- ③ FX(2C)+FX2-40AW

When using 485BD in system, this distance is 50m. (No use : max. 500m)  
But, when using FX2-40AW in system, this distance is 10m.

### 1.2.3 N:N Network

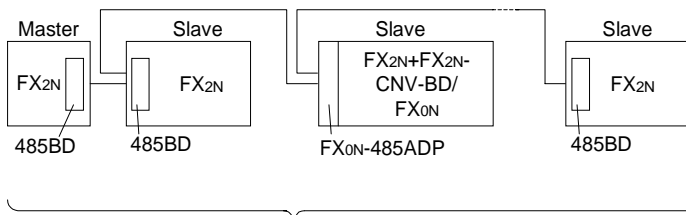

When using 485BD in the system, total extension distance is 50m (No use : max. 500m), max.8 stations.

## 2. MOUNTING AND WIRING

### 2.1 Mounting Procedure

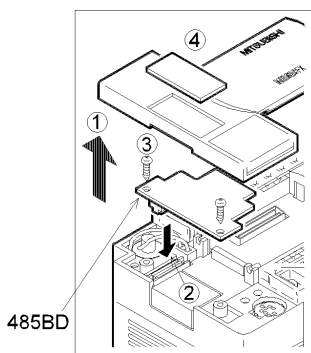

Turn off the power of the programmable controller, and mount the 485BD using the following procedure.

- ① Remove the panel cover from the top face of the base unit.
- ② Connect the connector for programmable controller provided on the 485BD to the board mounting connector provided on the base unit.
- ③ Fix the 485BD to the base unit using the M3 self-tapping screws supplied. Tightening torque: 0.3 to 0.6 N•m (3 to 6 kgf•cm)
- ④ Remove the cut out on the left of the panel cover using a tool such as nippers or cutters so that the terminal block is accessible. The top face of this terminal block is higher than the top face of the panel cover of the programmable controller by approximately 7 mm.

### 2.2 Cable and Terminal Resistor

#### 2.2.1 Cable

To connect the RS485 (422) unit, use a shielded twisted-pair cable. The cable specification must be AWG 26 to 16, and the maximum tightening torque must be 0.6 N•m (6 kgf•cm). If a cable other than the AWG 26 to 16 is used, normal communication cannot be assured because the terminal may be imperfectly contacted. It is recommended to insert a cable integrated by the crimping tool into the terminal.



#### 2.2.2 Terminal Resistor

Provide the terminal resistor at both ends of the line as described in section 2.3.2 and 2.3.3.

- 1) In the case of two-pair wiring, connect the terminal resistor (330Ω, 1/4W) between terminals SDA and SDB as well as between terminals RDA and RDB. Use the resistors offered as accessories of the 485BD.
- 2) In the case of one-pair wiring, connect the terminal resistor (110Ω, 1/2W) between terminals RDA and RDB. Use the resistors offered as accessories of the 485BD.

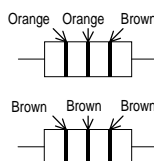

## 2.3 Wiring

### 2.3.1 Selection of Wiring

Wiring of RS485 is one-pair wiring or two-pair wiring. The wiring method is decided according to the usage. Please select the wiring method from the table below.

Usage		One-pair wiring (Refer to section2.3.3)	Two-pair wiring (Refer to section2.3.2)
No protocol (Use RS instruction) *1	Half-duplex communication	⊙*2	○
	Full-duplex communication *3	×	○
Dedicated protocol (Use computer link) *1	If is necessary to set the message wait to 70ms or less	×	○
	If is not necessary to set the message wait to 70ms or less	⊙*2	○
	Use on-demand function	×	○
Parallel link (Refer to section 2.3.4) *4		⊙	○
N:N network		○	×

⊙ . . . . Recommendation, ○ . . . .OK, × . . . . Can not use

\*1 When this product is added to the system, please match the wiring to the wiring method of the system.

\*2 When using 485BD with, this wiring method remember to take account of/or ignore the "echo" of the commands sent from the FX2N programmable controller.

\*3 Use FX2N programmable controller and 485BD together.

\*4 For excluding the combination of 485BD, please see below.

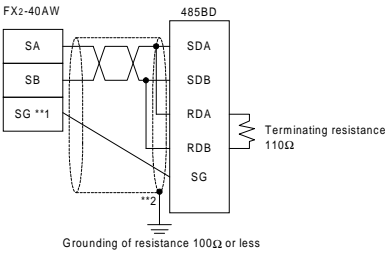

\*\*1 Connect the SG terminal to SG terminal of FX or FX2C main unit.

\*\*2 Connect the shield of shielded twisted pair cable to ground (100Ω or less).please adjust the grounding only to one side.

### 2.3.2 Two-pair Wiring

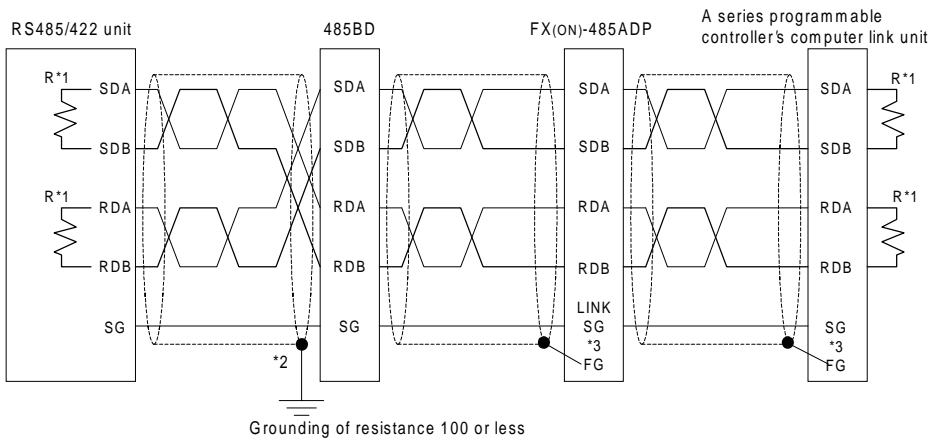

\*1 R is the terminating resistance. Connect the terminating resistance (330Ω) between terminals SDA and SDB, and terminals RDA and RDB.

\*2 The shield of the shielded twisted-pair cable must be connected to ground (100Ω or less). When using parallel link, ground both side. When using no protocol or dedicated protocol, ground one side.

\*3 Connect terminal FG to each terminal of the programmable controller main body grounded with resistance of 100 or less. However, for the computer link unit of the A series programmable controller, see the manual of the computer link unit.

\*4 When using RS232/485 or RS232/422 interface, please the use FX-485PC-IF.

### 2.3.3 One-pair Wiring

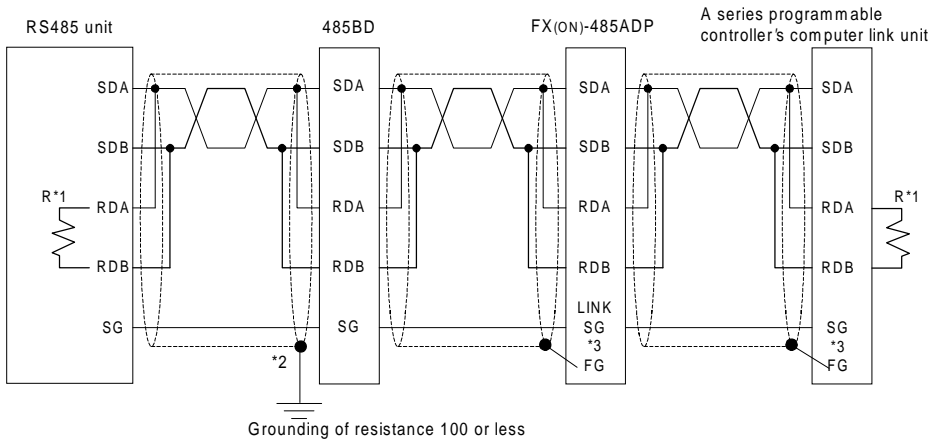

- \*1 R is the terminating resistance. Connect the terminating resistance (110Ω) between terminals RDA and RDB.
- \*2 The shield of the shielded twisted-pair cable must be connected to ground (100Ω or less). When using parallel link, ground both side. When using no protocol or dedicated protocol, ground one side.
- \*3 Connect terminal FG to each terminal of the programmable controller main body grounded with resistance of 100 or less. However, for the computer link unit of the A series programmable controller, see the manual of the computer link unit.
- \*4 When using RS232/485 or RS232/422 interface, please use FX-485PC-IF.

## 3. SPECIFICATIONS

### 3.1 General Specifications

General specifications are the same as those for the FX2N series programmable controller.

### 3.2 Power Supply Specification

5V DC, 60 mA is supplied from the programmable controller.

### 3.3 Specification

Item	Content
Transmission standard	Conforming to RS485 and RS422
Transmission distance	Max. 50 m
LED indicators	SD, RD

Item	Content
Communication method and protocol	N:N network
	Dedicated protocol (format 1 or format 4)
	Parallel link
	No protocol
Supported baud rate	Dedicated protocol and no protocol: 300 ~ 19,200 (bps) Parallel link : 19,200 (bps) N:N network : 38,400 (bps)
Isolation	No isolation

---

---

## 4. DIAGNOSTICS

---

---

For error code of N:N network and computer link, refer to the FX Communication User's Manual.

### 4.1 Common Items

- 1) Check the connection with the communication unit of the programmable controller and the wiring. When the connection is unstable, the communication can not be corrected.
- 2) Check whether the VRRD or VRSC instruction is used in the program. If it is used, delete it, turn off the power of the programmable controller, then turn it on again.
- 3) Each setting of communication format (D8120), parameter of programmable controller by FX-PCS/WIN-E, N:N network (D8173 to D8180) and parallel link (M8070, M8071) is suitable for the usage or it checks. The communication is not correctly done if setting is not suitable for the usage. When each setting is changed, please turn off the power supply of the programmable controller, and turn it on again.
- 4) When you use FX0N-485ADP or FX-485ADP in network, please the power supply for the drive must be supplied correctly or check.

### 4.2 LED Check Items

#### 4.2.1 N:N Network

- 1) Check the status of the RD LED and the SD LED provided on each 485BD.
  - If both of them are lit and extinguished, nothing is wrong.
  - If the RD LED is lit/extinguished but the SD LED is not lit/extinguished (not lit at all), check the setting of the station No., the baud rate (transmission rate) and the total number of slave stations.
  - If the RD LED is not lit/extinguished, check the wiring.
- 2) Make sure that the communication error (FX2N: M8183 to M8190, FX0N: M504 to M511) in each slave station is not turned on and that the data communication flag (FX2N: M8191, FX0N: M503) is not turned off. When one of the communication error flag is turned on or if the data communication flag is turned off, check the error code of data registers (FX2N: D8211 to D8218, FX0N: D211 to D218). For the error code, please see the FX Communication User's Manual.

### 4.3 Parallel Link

- 1) Check the status of the RD(RXD) LED and the SD(TXD) LED provided on each communication unit.
  - If both of them are lit and extinguished, nothing is wrong.
  - If the RD(RXD) LED is lit/extinguished but the SD(TXD) LED is not lit/extinguished (not lit at all), check the setting of the master station and the slave stations.
  - If the RD(RXD) LED is not lit/extinguished, check the wiring.
- 2) Make sure that the master station and the slave stations are set correctly. If the setting is incorrect, correct it.
- 3) Make sure that the devices for the master station and the slave stations are handled correctly. If they are handled incorrectly, correct the program so that they are handled correctly.

### 4.4 Computer Link

- 1) Check the status of the RD(RXD) LED and the SD(TXD) LED provided on each communication unit.
  - If both of them are lit and extinguished, nothing is wrong.
  - If the RD(RXD) LED is lit/extinguished but the SD(TXD) LED is not lit/extinguished (not lit at all), check the setting of the station No. and the transmission rate (baud rate).
  - If the RD(RXD) LED is not lit/extinguished, check the wiring and confirm the connection with the programmable controller.
- 2) Make sure that the communication procedure is performed correctly. If it is not performed correctly, correct the setting in the computer.
- 3) Check the NAK error code and programmable controller error code. For the error code, please see the FX Communication User's Manual.

## 4.5 RS Instruction

- 1) Check the status of the RD (RXD) LED and the SD (TXD) LED provided in an optional equipment.
  - If the RD (RXD) LED is not lit while data is received or the SD (TXD) LED is not lit while data is sent, check the installation and the wiring.
  - When the RD (RXD) LED is lit while data is received or the SD (TXD) LED is lit while data is sent, the installation and the wiring are correct.
- 2) Make sure the timing of data send/receive. For example, make sure that the counterpart equipment is ready for receive before starting to send data to it.
- 3) When the terminator is not used, check whether the send data capacity is equivalent to the acceptable data capacity. If the send data capacity may be changed, use the terminator.
- 4) Make sure that the external equipment is correctly operating.
- 5) Check whether the type of send data and the type of receive data are equivalent. If they are different, make them equivalent.
- 6) When two or more RS instructions are used in the program, make sure that only one RS instruction is actuated in one operation cycle. Never turn off the RS instruction while data is received or sent.
  
- 7) In the FX<sub>2N</sub> Series (V2.00 or later), an RS instruction is not executed if the counterpart equipment receives "NAK".  
Arrange the system so that the RS instruction is executed even if the counterpart equipment receives "NAK".

### Guidelines for the safety of the user and protection of the FX<sub>2N</sub>-485-BD Communication Board

- This manual has been written to be used by trained and competent personnel. This is defined by the European directives for machinery, low voltage and EMC.
- If in doubt at any stage during the installation of the FX<sub>2N</sub>-485-BD always consult a professional electrical engineer who is qualified and trained to the local and national standards. If in doubt about the operation or use of the FX<sub>2N</sub>-485-BD please consult the nearest Mitsubishi Electric distributor.
- Under no circumstances will Mitsubishi Electric be liable or responsible for any consequential damage that may arise as a result of the installation or use of this equipment.
- All examples and diagrams shown in this manual are intended only as an aid to understanding the text, not to guarantee operation. Mitsubishi Electric will accept no responsibility for actual use of the product based on these illustrative examples.
- Owing to the very great variety in possible application of this equipment, you must satisfy yourself as to its suitability for your specific application.

Manual number : JY992D73401

Manual revision : A

Date : MAY 1998

 **MITSUBISHI ELECTRIC CORPORATION**

HEAD OFFICE : MITSUBISHI DENKI BLDG MARUNOUTI TOKYO 100 TELEX : J24532 CABLE MELCO TOKYO  
HIMEJI WORKS : 840, CHIYODA CHO, HIMEJI, JAPAN

# FX<sub>2N</sub>

FX<sub>2N</sub>-485-BD COMMUNICATION BOARD

## HARDWARE MANUAL

JY992D73401A

This manual contains text, diagrams and explanations which will guide the reader in the correct installation and operation of the FX<sub>2N</sub>-485-BD COMMUNICATION BOARD. It should be read and understood before attempting to install or use the unit. Further information can be found in the FX PROGRAMMING MANUAL, FX<sub>2N</sub> series hardware manuals and manual of FX COMMUNICATION USER'S MANUAL.

If in doubt at any stage during the installation of the FX<sub>2N</sub>-485-BD COMMUNICATION BOARD always consult a professional electrical engineer who is qualified and trained to the local and national standards.

## 1. INTRODUCTION

The communication board FX<sub>2N</sub>-485-BD for RS485 (hereinafter referred to as "485BD") can be connected to the base unit of the FX<sub>2N</sub> Series programmable controller to be used for the following applications.

### 1) Data transfer using no protocol

Data communication with diversified RS232C units including personal computers, bar code readers and printers can be performed via the RS485 (422) converter using the no protocol. In this application, data is sent or received using the data registers specified by the RS instruction. For the setting and program examples, refer to the FX Programming Manual and FX Communication User's Manual.

### 2) Data transfer using the dedicated protocol

Data transfer with RS485 (422) units can be performed on the 1:N basis using the dedicated protocol. For the contents of the dedicated protocol used in this application, refer to the FX Communication User's Manual.

### 3) Data transfer using the parallel link

Data transfer with an FX<sub>2N</sub> programmable controller can be performed on the 1:1 basis for 100 auxiliary relays and 10 data registers. For the setting and program examples, refer to the FX Communication User's Manual.

### 4) Data transfer using the N:N network

Data transfer with FX<sub>2N</sub> programmable controllers can be performed on the N:N basis. For the setting, the number of transferred data and program examples, refer to the FX Communication User's Manual.

## 1.1 External Dimensions

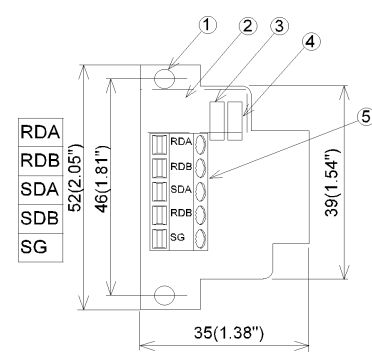

Dimensions : mm(inches)

Accessory : M3 self-tapping screw×2,  
Terminal resistor 330Ω×2, 110Ω×1

- ① Mounting holes (2∅- 4.0(0.16"))
- ② Connector for programmable controller
- ③ SD LED: Flashes at high speed during sending.
- ④ RD LED: Flashes at high speed during receiving.
- ⑤ Terminals to connect RS485 unit The top face of this terminal block is higher than the top face of the panel cover of the programmable controller by approximately 7mm.

## 1.2 System Configuration

### 1.2.1 No Protocol or Dedicated Protocol

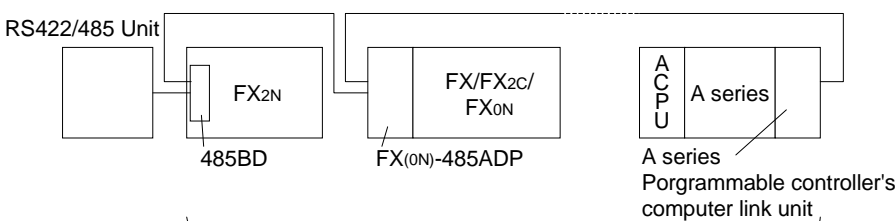

When using 485BD in the system, total extension distance is 50m. (No use : max. 500m)  
When using dedicated protocol, max.16 stations including A series programmable controller.

### 1.2.2 Parallel Link

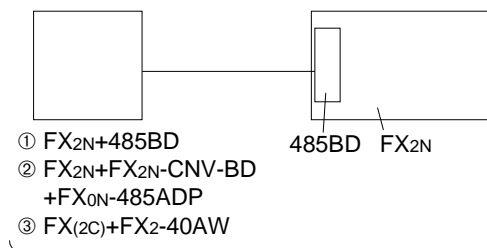

- ① FX<sub>2N</sub>+485BD
- ② FX<sub>2N</sub>+FX<sub>2N</sub>-CNV-BD  
+FX<sub>0N</sub>-485ADP
- ③ FX(2C)+FX<sub>2</sub>-40AW

When using 485BD in system, this distance is 50m. (No use : max. 500m)  
But, when using FX<sub>2</sub>-40AW in system, this distance is 10m.

### 1.2.3 N:N Network

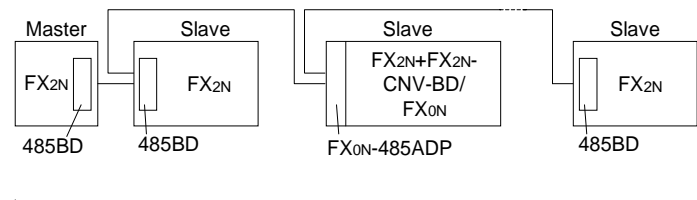

When using 485BD in the system, total extension distance is 50m (No use : max. 500m), max.8 stations.

## 2. MOUNTING AND WIRING

### 2.1 Mounting Procedure

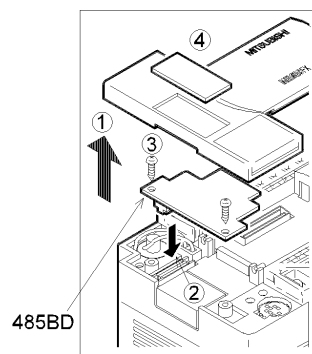

Turn off the power of the programmable controller, and mount the 485BD using the following procedure.

- ① Remove the panel cover from the top face of the base unit.
- ② Connect the connector for programmable controller provided on the 485BD to the board mounting connector provided on the base unit.
- ③ Fix the 485BD to the base unit using the M3 self-tapping screws supplied. Tightening torque: 0.3 to 0.6 N•m (3 to 6 kgf•cm)
- ④ Remove the cut out on the left of the panel cover using a tool such as nippers or cutters so that the terminal block is accessible. The top face of this terminal block is higher than the top face of the panel cover of the programmable controller by approximately 7 mm.

### 2.2 Cable and Terminal Resistor

#### 2.2.1 Cable

To connect the RS485 (422) unit, use a shielded twisted-pair cable. The cable specification must be AWG 26 to 16, and the maximum tightening torque must be 0.6 N•m (6 kgf•cm). If a cable other than the AWG 26 to 16 is used, normal communication cannot be assured because the terminal may be imperfectly contacted. It is recommended to insert a cable integrated by the crimping tool into the terminal.



#### 2.2.2 Terminal Resistor

Provide the terminal resistor at both ends of the line as described in section 2.3.2 and 2.3.3.

- 1) In the case of two-pair wiring, connect the terminal resistor (330Ω, 1/4W) between terminals SDA and SDB as well as between terminals RDA and RDB. Use the resistors offered as accessories of the 485BD.
- 2) In the case of one-pair wiring, connect the terminal resistor (110Ω, 1/2W) between terminals RDA and RDB. Use the resistors offered as accessories of the 485BD.

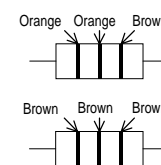

## 2.3 Wiring

### 2.3.1 Selection of Wiring

Wiring of RS485 is one-pair wiring or two-pair wiring. The wiring method is decided according to the usage. Please select the wiring method from the table below.

Usage		One-pair wiring (Refer to section2.3.3)	Two-pair wiring (Refer to section2.3.2)
No protocol (Use RS instruction) *1	Half-duplex communication	⊙*2	○
	Full-duplex communication *3	×	○
Dedicated protocol (Use computer link) *1	If is necessary to set the message wait to 70ms or less	×	○
	If is not necessary to set the message wait to 70ms or less	⊙*2	○
	Use on-demand function	×	○
Parallel link (Refer to section 2.3.4) *4		⊙	○
N:N network		○	×

⊙ . . . . Recommendation, ○ . . . .OK, × . . . . Can not use

\*1 When this product is added to the system, please match the wiring to the wiring method of the system.

\*2 When using 485BD with, this wiring method remember to take account of/or ignore the "echo" of the commands sent from the FX<sub>2N</sub> programmable controller.

\*3 Use FX<sub>2N</sub> programmable controller and 485BD together.

\*4 For excluding the combination of 485BD, please see below.

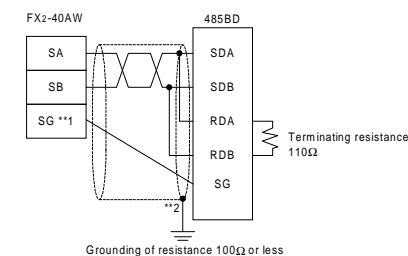

\*\*1 Connect the SG terminal to SG terminal of FX or FX<sub>2C</sub> main unit.

\*\*2 Connect the shield of shielded twisted pair cable to ground (100Ω or less).please adjust the grounding only to one side.

### 2.3.2 Two-pair Wiring

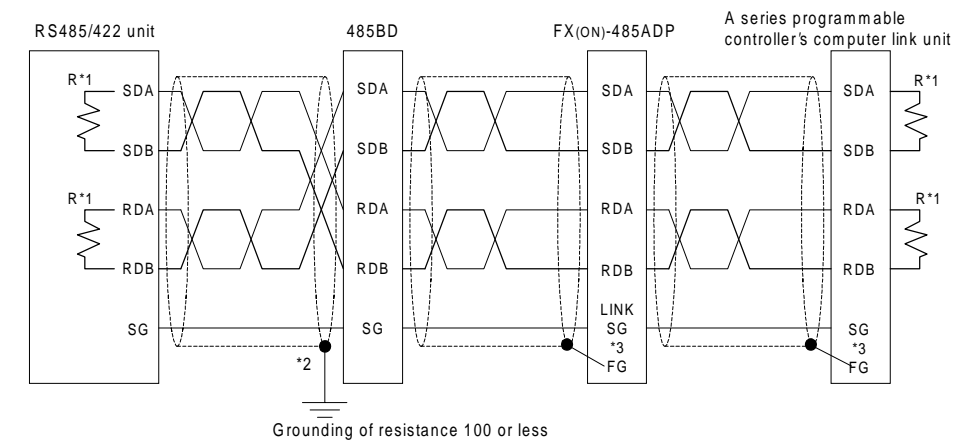

\*1 R is the terminating resistance. Connect the terminating resistance (330Ω) between terminals SDA and SDB, and terminals RDA and RDB.

\*2 The shield of the shielded twisted-pair cable must be connected to ground (100Ω or less). When using parallel link, ground both side. When using no protocol or dedicated protocol, ground one side.

\*3 Connect terminal FG to each terminal of the programmable controller main body grounded with resistance of 100 or less. However, for the computer link unit of the A series programmable controller, see the manual of the computer link unit.

\*4 When using RS232/485 or RS232/422 interface, please the use FX-485PC-IF.

### 2.3.3 One-pair Wiring

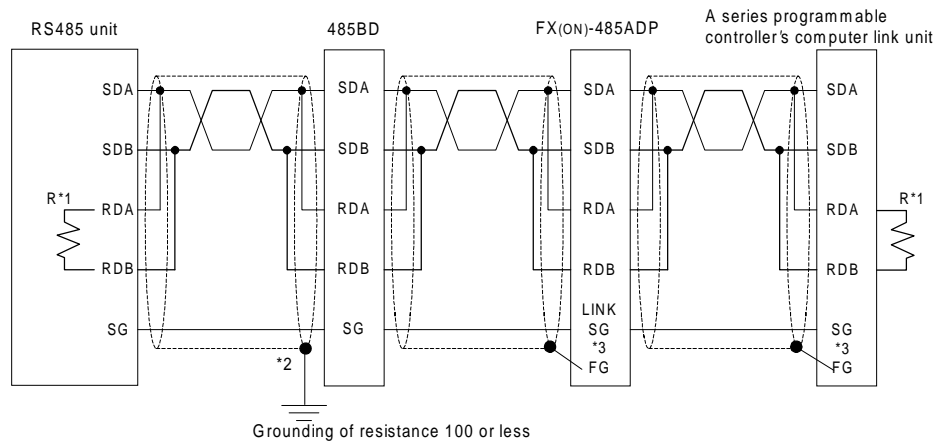

\*1 R is the terminating resistance. Connect the terminating resistance (110Ω) between terminals RDA and RDB.

\*2 The shield of the shielded twisted-pair cable must be connected to ground (100Ω or less). When using parallel link, ground both side. When using no protocol or dedicated protocol, ground one side.

\*3 Connect terminal FG to each terminal of the programmable controller main body grounded with resistance of 100 or less. However, for the computer link unit of the A series programmable controller, see the manual of the computer link unit.

\*4 When using RS232/485 or RS232/422 interface, please use FX-485PC-IF.

## 3. SPECIFICATIONS

### 3.1 General Specifications

General specifications are the same as those for the FX<sub>2N</sub> series programmable controller.

### 3.2 Power Supply Specification

5V DC, 60 mA is supplied from the programmable controller.

### 3.3 Specification

Item	Content
Transmission standard	Conforming to RS485 and RS422
Transmission distance	Max. 50 m
LED indicators	SD, RD

Item	Content	
Communication method and protocol	N:N network	Half-duplex communication
	Dedicated protocol (format 1 or format 4)	
	Parallel link	
	No protocol	Full-duplex communication
Supported baud rate	Dedicated protocol and no protocol: 300 ~ 19,200 (bps) Parallel link : 19,200 (bps) N:N network : 38,400 (bps)	
Isolation	No isolation	

## 4. DIAGNOSTICS

For error code of N:N network and computer link, refer to the FX Communication User's Manual.

### 4.1 Common Items

- 1) Check the connection with the communication unit of the programmable controller and the wiring. When the connection is unstable, the communication can not be corrected.
- 2) Check whether the VRRD or VRSC instruction is used in the program. If it is used, delete it, turn off the power of the programmable controller, then turn it on again.
- 3) Each setting of communication format (D8120), parameter of programmable controller by FX-PCS/WIN-E, N:N network (D8173 to D8180) and parallel link (M8070, M8071) is suitable for the usage or it checks. The communication is not correctly done if setting is not suitable for the usage. When each setting is changed, please turn off the power supply of the programmable controller, and turn it on again.
- 4) When you use FX0N-485ADP or FX-485ADP in network, please the power supply for the drive must be supplied correctly or check.

### 4.2 LED Check Items

#### 4.2.1 N:N Network

- 1) Check the status of the RD LED and the SD LED provided on each 485BD.
  - If both of them are lit and extinguished, nothing is wrong.
  - If the RD LED is lit/extinguished but the SD LED is not lit/extinguished (not lit at all), check the setting of the station No., the baud rate (transmission rate) and the total number of slave stations.
  - If the RD LED is not lit/extinguished, check the wiring.
- 2) Make sure that the communication error (FX<sub>2N</sub>: M8183 to M8190, FX<sub>0N</sub>: M504 to M511) in each slave station is not turned on and that the data communication flag (FX<sub>2N</sub>: M8191, FX<sub>0N</sub>: M503) is not turned off. When one of the communication error flag is turned on or if the data communication flag is turned off, check the error code of data registers (FX<sub>2N</sub>: D8211 to D8218, FX<sub>0N</sub>: D211 to D218). For the error code, please see the FX Communication User's Manual.

### 4.3 Parallel Link

- 1) Check the status of the RD(RXD) LED and the SD(TXD) LED provided on each communication unit.
  - If both of them are lit and extinguished, nothing is wrong.
  - If the RD(RXD) LED is lit/extinguished but the SD(TXD) LED is not lit/extinguished (not lit at all), check the setting of the master station and the slave stations.
  - If the RD(RXD) LED is not lit/extinguished, check the wiring.
- 2) Make sure that the master station and the slave stations are set correctly. If the setting is incorrect, correct it.
- 3) Make sure that the devices for the master station and the slave stations are handled correctly. If they are handled incorrectly, correct the program so that they are handled correctly.

### 4.4 Computer Link

- 1) Check the status of the RD(RXD) LED and the SD(TXD) LED provided on each communication unit.
  - If both of them are lit and extinguished, nothing is wrong.
  - If the RD(RXD) LED is lit/extinguished but the SD(TXD) LED is not lit/extinguished (not lit at all), check the setting of the station No. and the transmission rate (baud rate).
  - If the RD(RXD) LED is not lit/extinguished, check the wiring and confirm the connection with the programmable controller.
- 2) Make sure that the communication procedure is performed correctly. If it is not performed correctly, correct the setting in the computer.
- 3) Check the NAK error code and programmable controller error code. For the error code, please see the FX Communication User's Manual.

### 4.5 RS Instruction

- 1) Check the status of the RD (RXD) LED and the SD (TXD) LED provided in an optional equipment.
  - If the RD (RXD) LED is not lit while data is received or the SD (TXD) LED is not lit while data is sent, check the installation and the wiring.
  - When the RD (RXD) LED is lit while data is received or the SD (TXD) LED is lit while data is sent, the installation and the wiring are correct.
- 2) Make sure the timing of data send/receive. For example, make sure that the counterpart equipment is ready for receive before starting to send data to it.
- 3) When the terminator is not used, check whether the send data capacity is equivalent to the acceptable data capacity. If the send data capacity may be changed, use the terminator.
- 4) Make sure that the external equipment is correctly operating.
- 5) Check whether the type of send data and the type of receive data are equivalent. If they are different, make them equivalent.
- 6) When two or more RS instructions are used in the program, make sure that only one RS instruction is actuated in one operation cycle. Never turn off the RS instruction while data is received or sent.
- 7) In the FX<sub>2N</sub> Series (V2.00 or later), an RS instruction is not executed if the counterpart equipment receives "NAK". Arrange the system so that the RS instruction is executed even if the counterpart equipment receives "NAK".

### Guidelines for the safety of the user and protection of the FX<sub>2N</sub>-485-BD Communication Board

- This manual has been written to be used by trained and competent personnel. This is defined by the European directives for machinery, low voltage and EMC.
- If in doubt at any stage during the installation of the FX<sub>2N</sub>-485-BD always consult a professional electrical engineer who is qualified and trained to the local and national standards. If in doubt about the operation or use of the FX<sub>2N</sub>-485-BD please consult the nearest Mitsubishi Electric distributor.
- Under no circumstances will Mitsubishi Electric be liable or responsible for any consequential damage that may arise as a result of the installation or use of this equipment.
- All examples and diagrams shown in this manual are intended only as an aid to understanding the text, not to guarantee operation. Mitsubishi Electric will accept no responsibility for actual use of the product based on these illustrative examples.
- Owing to the very great variety in possible application of this equipment, you must satisfy yourself as to its suitability for your specific application.

Manual number : JY992D73401

Manual revision : A

Date : MAY 1998

**MITSUBISHI ELECTRIC CORPORATION**

HEAD OFFICE : MITSUBISHI DENKI BLDG MARUNOUCHI TOKYO 100 TELEX : J24532 CABLE MELCO TOKYO  
HIMEJI WORKS : 840, CHIYODA CHO, HIMEJI, JAPAN