

MITSUBISHI

A1SJ71QLP21(S)/A1SJ71QBR11 MELSECNET/10 Network Module

User's Manual (Hardware)

Thank you for buying the Mitsubishi General Use PC MELSEC-QnA Series. Before use, please read this manual carefully and correctly operate the module with a sufficient understanding of the QnA series PC functions and performance. Please place this manual in a location where it is available to end users.



MODEL	A1SQLP21QBR11UHW E
MODEL CODE	13JL25

IB-66784-A (9706) MEE

The United States	Mitsubishi Electronics America, Inc., (Industrial Automation Division) 800 Biemann Court, Mt. Prospect, IL 60056. Phone : (708) 298-9223
Canada	Mitsubishi Electric Sales Canada, Inc., (Industrial Automation Division) 4299 14th Avenue, Markham, Ontario L3R OJ2 Phone : (416) 475-7728
United Kingdom	Mitsubishi Electric UK Ltd., (Industrial Sales Division) Travellers Lane, Hatfield, Herts., AL10 8XB Phone : (0707) 276100
Germany	Mitsubishi Electric Europe GmbH, (Industrial Automation Division) Gothaer Strasse 8, Postfach 1548, D-4030 Ratingen 1 Phone : (02102) 4860
Taiwan	Setsuyo Enterprise Co., Ltd., (106) 11th Fl., Chung-Ling Bldg., 363, Sec. 2, Fu-Hsing S. Rd., Taipei, Taiwan. R.O.C. Phone : (02) 732-0161
Hongkong (& China)	Ryoden International Ltd., (Industrial & Electrical Controls Division) 10/F., Manulife Tower, 169 Electric Rd., North Point, Hong Kong. Phone : 8878870
Singapore (& Malaysia)	MELCO Sales Singapore Pte. Ltd., (Industrial Division) 307 Alexandra Rd. #05-01/02, Mitsubishi Electric Bldg., Singapore 0315. Phone : 4732308
Thailand	F.A. Tech Co., Ltd., 1138/33-34 Rama 3 Rd., Yannawa, Bangkok 10120. Phone : (02) 295-2861-4
Australia	Mitsubishi Electric Australia Pty. Ltd., (Industrial Controls Division) 348 Victoria Rd., Rydalm ere, N.S.W. 2116. Phone : (02) 684-7200
Republic of South Africa	M.S.A. Manufacturing (Pty) Ltd., (Factory Automation Division) P.O. Box 39733, Bramley, Johannesburg 2018. Phone : (011) 444-8080



When exported from Japan, this manual does not require application to the Ministry of International Trade and Industry for service transaction permission.

SAFETY PRECAUTIONS

(Read these precautions before using.)

When using Mitsubishi equipment, thoroughly read this manual and the associated manuals introduced in this manual. Also pay careful attention to safety and handle the module properly.

These precautions apply only to Mitsubishi equipment. Refer to the CPU module user's manual for a description of the PC system safety precautions.

These SAFETY PRECAUTIONS classify the safety precautions into two categories: "DANGER" and "CAUTION".

!DANGER

Procedures which may lead to a dangerous condition and cause death or serious injury if not carried out properly.

#CAUTION

Procedures which may lead to a dangerous condition and cause superficial to medium injury, or physical damage only, if not carried out properly.

Depending on circumstances, procedures indicated by #CAUTION may also be linked to serious results.

In any case, it is important to follow the directions for usage.

Store this manual in a safe place so that you can take it out and read it whenever necessary. Always forward it to the end user.

[DESIGN PRECAUTIONS]

!DANGER

- When there are communication problems with the data link, the communication problem station will enter the following condition.
Build an interlock circuit into the sequence program that will make sure the system operates safely by using the communication state information.
Not doing so could result in erroneous output or erroneous operation.
 - (1) For the data link data, the data prior to the communication error will be held.
 - (2) The remote I/O station will turn all output off.

[DESIGN PRECAUTIONS]

#CAUTION

- Do not bunch the control wires or communication cables with the main circuit or power wires, or install them close to each other. They should be installed 100mm (3.9 inch) or more from each other. Not doing so could result in noise that would cause erroneous operation.

[INSTALLATION PRECAUTIONS]

#CAUTION

- Use the PC in an environment that meets the general specifications contained in this manual. Using this PC in an environment outside the range of the general specifications could result in electric shock, fire, erroneous operation, and damage to or deterioration of the product.
- Do not touch the printed circuit board of the module. It may cause damage or erroneous operation.
- Install so that the pegs on the bottom of the module fit securely into the base unit peg holes.
The module fixing screws must be tightened by the specified torque (78 to 117N•cm (8 to 12kg•cm))
Not installing the module correctly or tightening the screws to the terminal base could result in erroneous operation, damage, or pieces of the product falling.

[WIRING PRECAUTIONS]

!DANGER

- Completely turn off the external power when installing or placing wiring. Not completely turning off all power could result in electric shock or damage to the product.

#CAUTION

- When wiring in the PC, be sure that it is done correctly by checking the product's rated voltage and the terminal layout. Connecting a power supply that is different from the rating or incorrectly wiring the product could result in fire or damage.
- Be sure there are no foreign substances such as sawdust or wiring debris inside the module. Such debris could cause fires, damage, or erroneous operation.
- Solder the coaxial cable connector properly. Incomplete soldering may cause a malfunction.

[STARTING AND MAINTENANCE PRECAUTIONS]

#CAUTION

- Before conducting operations such as changing the program while the module is operating, force output, run, stop, pause, etc., be sure to thoroughly read the manual and take due consideration for safety. Operation mistakes could cause damage to the equipment and other problems.
- Do not disassemble or modify the modules. Doing so could cause trouble, erroneous operation, injury, or fire.
- Turn the power off when removing a module, light connector plug and BNC connector. Trying to remove the module while the power is on could damage the module or result in erroneous operation.
- Do not touch light connector plug and BNC connector while power is on. Doing so could cause erroneous operation.
- Turn the power off when cleaning the module. Conducting these operations when the power is on could damage the module or result in erroneous operation.

[DISPOSAL PRECAUTIONS]

#CAUTION

- When disposing of this product, treat it as industrial waste.

Table of Contents

About This Manual

1 Overview	1
2 Performance Specifications	2
3 The Name and Setting of Each Part	4
4 Precautions Constructing a Coaxial Bus System	10
5 Handling	10
5.1 Cable length restrictions between stations	10
6 Link Special Relay (SB)/Register (SW)	11
6.1 Link special relay (SB)	13
6.2 Link special register (SW)	29
6.3 SB/SW Valid during offline test	56
7 Remote I/O Station Special Relay (M, SM)/ Special Register (D, SD)	57
7.1 Special relay (M, SM)	57
7.2 Special register (D, SD)	59
8 Duplex Network Special Link Relay (SB)/ Register (SW)	63
8.1 Special link relay (SB)	63
8.2 Special link register (SW)	64
9 Error Codes	65
10 External Dimensions	74
10.1 A1SJ71QLP21	74
10.2 A1SJ71QLP21(S)	74
10.3 A1SJ71QBR11	75

About This Manual

The following product manuals are available. Please use this table as a reference to request the appropriate manual as necessary.

Detailed Manual

Manual Name	Manual No. (Type Code)
For QnA/Q4AR MELSECNET/10 Network System Reference Manual	IB-66690 (13JF78)

1 Overview

This manual explains the specifications and names of each part, etc., of the A1SJ71QLP21(S) model network module and the A1SJ71QBR11 model network module which are used with MELSECNET/10 network system of the MELSEC-QnA series.

(1) The use, cable used and installation position of the A1SJ71QLP21(S) and the A1SJ71QBR11 are indicated on the following chart.

	Use	Cable used		Application
		Optical fiber cable	Coaxial cable	
A1SJ71QLP21(S)	The control station, normal station and master station of MELSECNET/10	b	—	Main base, Extension base I/O slot
A1SJ71QBR11		—	b	

(2) Please verify the existence of the following parts after opening the package.

(a) In the case of A1SJ71QLP21

Product name	Quantity
A1SJ71QLP21 Network module	1

(b) In the case of A1SJ71QLP21S

Product name	Quantity
A1SJ71QLP21S Network module	1

(c) In the case of A1SJ71QBR11

Product name	Quantity
A1SJ71QBR11 Network module	1
F form connector (A6RCON-F)	1

(3) When constructing a coaxial bus system, a terminal resistor (A6RCON-R75) or a BNC-TMP-05 (75) manufactured by Hirose Electric Corp. is required for both system terminals. It is not included with the module and must be purchased separately.

(4) Application CPU
Q2ASCPU(S1), Q2ASHCPU (S1)

2 Performance Specifications

The performance specifications for A1SJ71QLP21(S)/A1SJ71QBR11 are indicated as follows.

Topic		A1SJ71QLP21(S)	A1SJ71QBR11	
Maximum link points per 1 network		X/Y	8192 points	
		B	8192 points	
		W	8192 points	
Maximum link points per 1 station	When constructing a PC network	$\left[\frac{B+Y}{8} + (2 \times W) \right] \leq 2000 \text{ bytes}$		
	When constructing a remote I/O network	<ul style="list-style-type: none"> Remote master station → remote I/O station $\left[\frac{B+Y}{8} + (2 \times W) \right] \leq 1600 \text{ bytes}$ Remote I/O station → remote master station $\left[\frac{B+X}{8} + (2 \times W) \right] \leq 1600 \text{ bytes}$ Remote master station → remote sub master station Remote sub master station → remote master station $\left[\frac{Y+B}{8} + (2 \times W) \right] \leq 2000 \text{ bytes}$ 		
Communication speed		10Mbps (20Mbps: Multiplex transmission)	10Mbps	
Communication method		Token ring mode	Token pass mode	
Synchronous mode		Frame synchronous mode		
Transmission circuit format		Double loop	Single pass	
General extension distance		30km	3C-2V	5C-2V
		SI cable H type inter station 300m	300m (inter station 300m)	500m (inter station 500m)
		SI cable L type inter station 500m QSI cable inter station 1km	Repeater module (A6BR10, A6BR10-DC) Maximum expansion is 2.5km	
Maximum number of networks		239		
Maximum number of groups		9 (Only in a PC network)		
Number of connection	When constructing a PC network	64 stations (Control station: 1 Normal stations: 63)	32 stations (Control station: 1 Normal stations: 31)	
Stations in 1 network	When constructing a remote I/O network	65 stations $\left[\text{Remote master station: 1 Remote I/O stations: 64} \right]$	33 stations $\left[\text{Remote master station: 1 Remote I/O stations: 32} \right]$	

Topic	A1SJ71QLP21(S)		A1SJ71QBR11
Maximum number of installation modules per 1 CPU	Q2ASCPU(S1), Q2ASHCPU(S1): 4		
Coding mode	NRZ1 signal (Non Return to Zero Inverted)		Manchester signal
Transmission format	HDLC performance (frame format)		
Error control format	Retry by CRC ($X^{16}+X^{12}+X^5+1$) and overtime		
RAS function	<ul style="list-style-type: none"> • Loop pack function due to abnormality detection and cable disconnection (A1SJ71QLP21(S)) • Diagnostic function for local link circuit check • Prevention of system down due to shifting to control station (Only for PC networks) • Abnormality detection by special relay, resistor • Network monitor, each type of diagnostic function • Transient transmission possible even when there is PC CPU abnormality (cause of abnormality can be verified from other station) • Prevention of loopback due to supplying external power (A1SJ71QLP21S) 		
Transient transmission	<ul style="list-style-type: none"> • N:N intercommunication (Monitor, program upload/download, etc.) 		
Connection cable	SI-200/220	QSI-185/230	3C-2V, 5C-2V Equivalent goods
Integration cable	Twin core light connector plug CA 7003		BNC-P-3-Ni-CAU BNC-P-5-Ni-CAU Equivalent goods (manufactured by DDK Electronics., LTD.)
Cable transmission loss	12dB/km or less	5.5 dB/km or less	In accordance with JIS C 3501
Consumption current (5VDC)	0.65A		0.8A
External supply power (A1SJ71QLP21(S) only)	Voltage	20.4 to 31.2VDC	
	Current	0.2A	
	Applicable wire size	0.75 to 2mm ²	
	Tightening torque	98 to 137.2N•cm (10 to 14kg•cm)	
Weight [kg (lb)]	0.3 (0.66) (A1SJ71QLP21(S): 0.42 (0.92))		
Input output occupancy points	32 points (A1SJ71QLP21(S): 48points, I/O slot: 2 slot occupy)		

For general specifications, please refer to PC CPU user manual used in the network system.

3 The Name and Setting of Each Part

Indicates the name and setting of each part of A1SJ71QLP21(S)/A1SJ71QBR11.

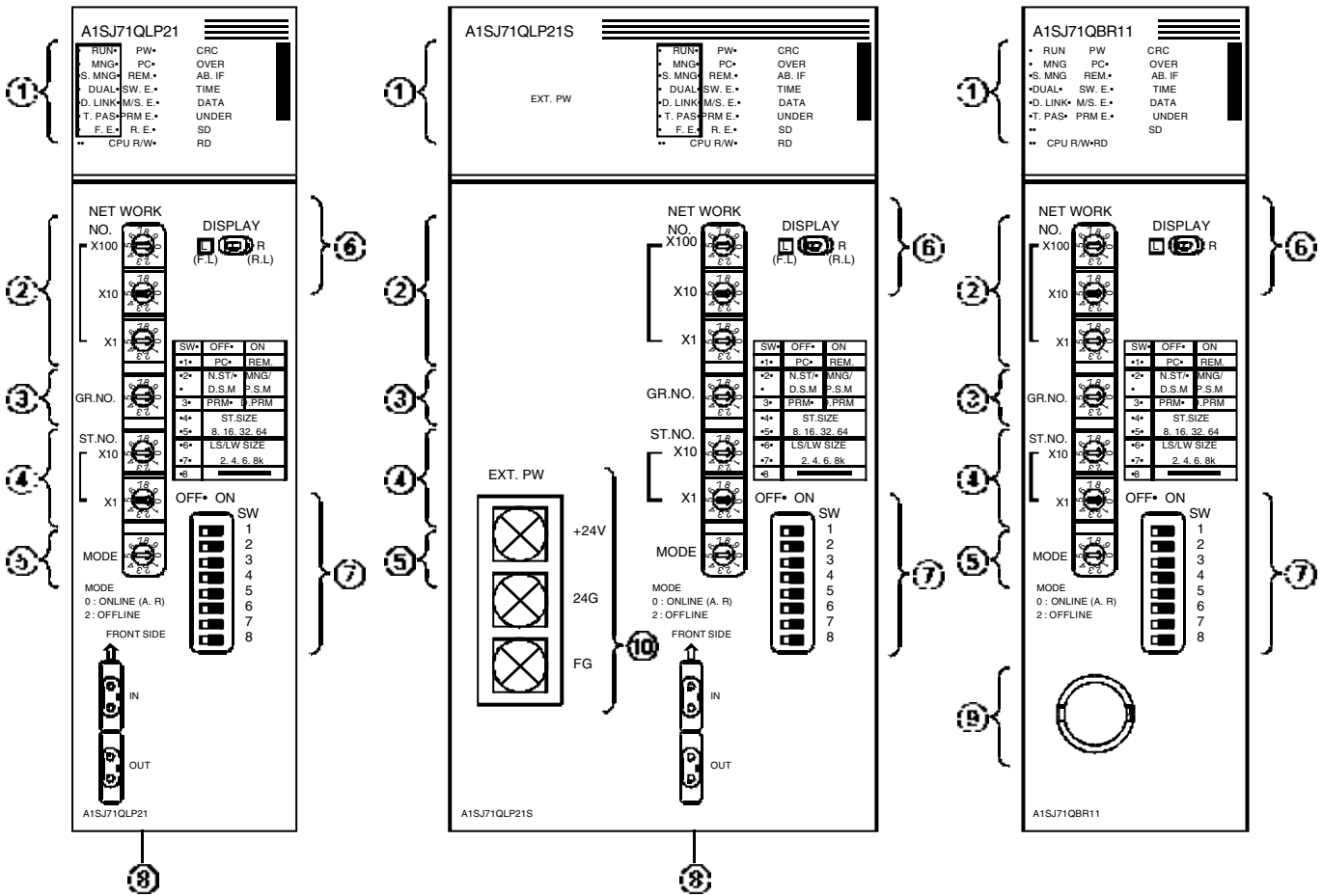

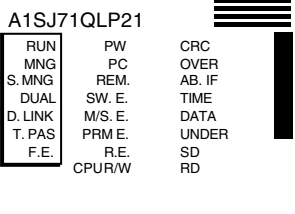

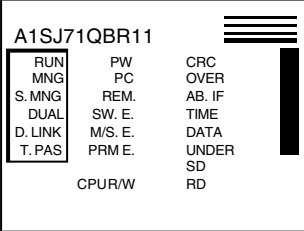
No.	Name	Contents	
1	LED A1SJ71QLP21  A1SJ71QLP21S's LED is the one that "EXP.PW" is added to the LED of A1SJ71QLP21.	RUN	Module at the normal time: lamp is lit When a WDT error is generated: lamp is not lit
		MNG	Control station, master station setting time: lamp is lit Normal station setting time: lamp is not lit
		S.MNG	When it is sub-management station: lamp is lit
		DUAL	During execution of multiplex transmission: lamp is lit
		D.LINK	During data link: lamp is lit
		T.PAS.	At the time of baton pass (transient transmission): lamp is lit
		The position of the switch for the display switch over of 6 is valid when it is on the left side.	

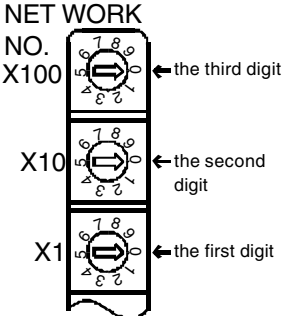
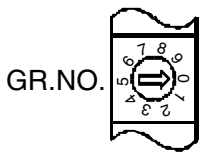
No.	Name	Contents		
1		F.E.	If there is an error when the Plus (F.Loop) loop is abnormal: lamp is lit <Primary cause> The power supply of the adjacent station is off, the cable is cut or not connected, etc.	
		PW	When the power supply is supplied: lamp is lit	
		PC	When setting a PC network: the lamp is lit (SW1 is off)	
		REM.	When setting a remote I/O: lamp is lit (turns on the SW1)	
		SW.E.	When there is an abnormality with a switch between 2 and 6: lamp is lit	
	<p>A1SJ71QBR11</p>  <p>The legend shows a grid of indicator lamps with labels: RUN, MNG, S.MNG, DUAL, D.LINK, T.PAS, PW, PC, REM., SW.E., M/S.E., PRM.E., CPU R/W, CRC, OVER, AB. IF, TIME, DATA, UNDER, SD, RD.</p>	M/S.E.	On the same network, at the time of station or control station duplication: lamp is lit	
		PRM E.	When there is a conformity error with a common parameter and station existent parameter and when the parameter received from a sub-management station and the local station parameter received from the management station are different: lamp is lit	The position of the switch for the display switch over of 6 is valid when it is on the right side.
		R.E.	If there is an error when the Sub (R. Loop) loop is abnormal: lamp is lit <Primary cause> The power supply of the adjacent station is off, the cable is cut or not connected, etc.	
		CPU R/W	During CPU communication exchange: lamp is lit	
		EXT.PW	When the external power supply (24VDC) is being supplied to A: lamp is lit	
		CRC	When there is a code check error of receiving data: lamp is lit <Primary cause> The timing of a station in parallel condition sending data to corresponding station, H/W abnormality, cable abnormality, noise, etc.	

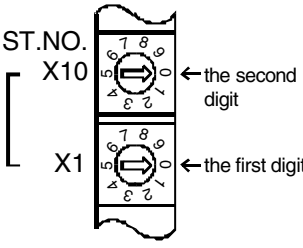
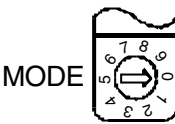
No.	Name	Contents	
1	LED	OVER	When there is an error due to delayed processing of receiving data: the lamp is lit <Primary cause> H/W abnormality, cable abnormality, noise, etc.
		AB.IF	Errors when successively receiving communication which is "1" above the regulations and or when the length of the receiving data is short: lamp is lit <Primary causes> The timing of a station in parallel condition sending data to the corresponding station, monitoring time is short, cable is abnormal, noise, etc.
		TIME	An error at the time that the data link timer is working: lamp is lit <Primary causes> Monitoring time is short, cable abnormality, noise, etc.
		DATA	Error when receiving abnormal data which is 2K bytes or over: lamp is lit. <Primary causes> Cable abnormality, noise, etc.
		UNDER	An error when the internal processing of the sending transmission data is not in constant intervals: lamp is lit <Primary causes> H/W abnormality
		SD	During data sending: lamp is lit
		RD	During data receiving: lamp is lit
2*1	Network number setting switch 	Network number setting (factory setting at time of shipping: 1) <Setting range> 1 to 239 :Network number Other than 1 to 239 :Setting error (SW.E LED lamp is lit) Becomes off-line condition	
3*1	Group number setting Switch 	Group number setting (factory setting at time of shipping: 0) <Setting range> 0 :no group setting 1 to 9 :group number } Valid at the time of PC network	

No.	Name	Contents																																			
4*1	Station number setting switch 	Station number setting (factory setting at time of shipping: 1) <table border="1" data-bbox="513 235 1410 568"> <thead> <tr> <th>Type</th> <th>Setting</th> </tr> </thead> <tbody> <tr> <td data-bbox="513 313 694 414">PC network</td> <td data-bbox="694 313 1410 414"> 1 to 64 :station number Other than 1 to 64 :setting error (SW.E led light is lit) </td> </tr> <tr> <td data-bbox="513 425 694 568">Remote I/O network</td> <td data-bbox="694 425 1410 568"> 0 :remote master station 1 to 64 :remote sub master station Other than 1 to 64 :setting error (SW.E LED light is lit) </td> </tr> </tbody> </table>	Type	Setting	PC network	1 to 64 :station number Other than 1 to 64 :setting error (SW.E led light is lit)	Remote I/O network	0 :remote master station 1 to 64 :remote sub master station Other than 1 to 64 :setting error (SW.E LED light is lit)																													
		Type	Setting																																		
		PC network	1 to 64 :station number Other than 1 to 64 :setting error (SW.E led light is lit)																																		
Remote I/O network	0 :remote master station 1 to 64 :remote sub master station Other than 1 to 64 :setting error (SW.E LED light is lit)																																				
5*1	Mode setting switch  MODE 0 : ONLINE (A. R) 2 : OFFLINE	Mode setting (factory setting at time of shipping: 0) <table border="1" data-bbox="513 616 1410 1769"> <thead> <tr> <th>Mode</th> <th>Name</th> <th>Contents</th> </tr> </thead> <tbody> <tr> <td data-bbox="513 649 651 728">0</td> <td data-bbox="651 649 944 728">On-line (automatic double line existent)</td> <td data-bbox="944 649 1410 728">Data link (automatic double line existent)</td> </tr> <tr> <td data-bbox="513 728 651 772">1</td> <td data-bbox="651 728 944 772">Use not possible</td> <td data-bbox="944 728 1410 772">—</td> </tr> <tr> <td data-bbox="513 772 651 840">2</td> <td data-bbox="651 772 944 840">Off-line</td> <td data-bbox="944 772 1410 840">Placing local station in parallel condition</td> </tr> <tr> <td data-bbox="513 840 651 952">3</td> <td data-bbox="651 840 944 952">Forward loop</td> <td data-bbox="944 840 1410 952">Data link system Check of all forward loop side circuits is executed.</td> </tr> <tr> <td data-bbox="513 952 651 1064">4</td> <td data-bbox="651 952 944 1064">Reverse loop</td> <td data-bbox="944 952 1410 1064">Data link system Check of all reverse loop side circuits is executed.</td> </tr> <tr> <td data-bbox="513 1064 651 1176">5</td> <td data-bbox="651 1064 944 1176">Test between stations (master stations)</td> <td data-bbox="944 1064 1410 1288" rowspan="2">By the mode which checks circuits between 2 stations, execute the check of the one which has a smaller number as the master station and the other as the sub master station.</td> </tr> <tr> <td data-bbox="513 1176 651 1288">6</td> <td data-bbox="651 1176 944 1288">Test between stations (sub master stations)</td> </tr> <tr> <td data-bbox="513 1288 651 1467">7</td> <td data-bbox="651 1288 944 1467">Self back to back test</td> <td data-bbox="944 1288 1410 1467">By the module simplex, check the hardware including the sending and receiving communication circuit of the transmission system and the cable.</td> </tr> <tr> <td data-bbox="513 1467 651 1624">8</td> <td data-bbox="651 1467 944 1624">Internal self back to back test</td> <td data-bbox="944 1467 1410 1624">By the unit simplex, check the hardware including the sending and receiving communication circuit of the transmission system.</td> </tr> <tr> <td data-bbox="513 1624 651 1691">9</td> <td data-bbox="651 1624 944 1691">Hardware test</td> <td data-bbox="944 1624 1410 1691">Check the internal hardware of the network module.</td> </tr> <tr> <td data-bbox="513 1691 651 1769">A to F</td> <td data-bbox="651 1691 944 1769">Use not possible (Do not set the mode.)</td> <td data-bbox="944 1691 1410 1769">—</td> </tr> </tbody> </table>	Mode	Name	Contents	0	On-line (automatic double line existent)	Data link (automatic double line existent)	1	Use not possible	—	2	Off-line	Placing local station in parallel condition	3	Forward loop	Data link system Check of all forward loop side circuits is executed.	4	Reverse loop	Data link system Check of all reverse loop side circuits is executed.	5	Test between stations (master stations)	By the mode which checks circuits between 2 stations, execute the check of the one which has a smaller number as the master station and the other as the sub master station.	6	Test between stations (sub master stations)	7	Self back to back test	By the module simplex, check the hardware including the sending and receiving communication circuit of the transmission system and the cable.	8	Internal self back to back test	By the unit simplex, check the hardware including the sending and receiving communication circuit of the transmission system.	9	Hardware test	Check the internal hardware of the network module.	A to F	Use not possible (Do not set the mode.)	—
		Mode	Name	Contents																																	
		0	On-line (automatic double line existent)	Data link (automatic double line existent)																																	
		1	Use not possible	—																																	
		2	Off-line	Placing local station in parallel condition																																	
		3	Forward loop	Data link system Check of all forward loop side circuits is executed.																																	
		4	Reverse loop	Data link system Check of all reverse loop side circuits is executed.																																	
		5	Test between stations (master stations)	By the mode which checks circuits between 2 stations, execute the check of the one which has a smaller number as the master station and the other as the sub master station.																																	
		6	Test between stations (sub master stations)																																		
		7	Self back to back test	By the module simplex, check the hardware including the sending and receiving communication circuit of the transmission system and the cable.																																	
		8	Internal self back to back test	By the unit simplex, check the hardware including the sending and receiving communication circuit of the transmission system.																																	
		9	Hardware test	Check the internal hardware of the network module.																																	
		A to F	Use not possible (Do not set the mode.)	—																																	

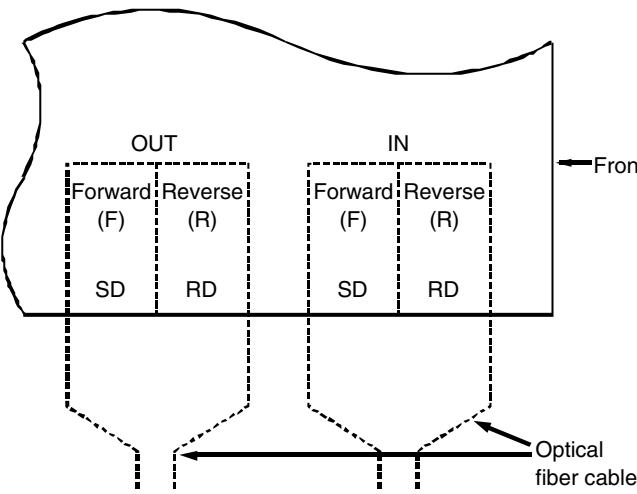
No.	Name	Contents																																																																																							
6	Switch for mode switch over DISPLAY 	Switch over of forward/reverse loop of the error display of CRC-Under and the display switch over of Run-F.E./PW-R.E. (factory setting at the time of shipping: left side)																																																																																							
		<table border="1"> <thead> <tr> <th>Switch position</th> <th>Contents</th> </tr> </thead> <tbody> <tr> <td>L (F.L.)</td> <td>The CRC-Under error display is set to the forward loop side and the RUN to R.E. display is set to valid.</td> </tr> <tr> <td>R (R.L.)</td> <td>(PW to R.E. display is invalid) The CRC-Under error display is set to the reverse loop side and the PW to R.E. display is set to valid. (RUN to R.E. display is invalid)</td> </tr> </tbody> </table>	Switch position	Contents	L (F.L.)	The CRC-Under error display is set to the forward loop side and the RUN to R.E. display is set to valid.	R (R.L.)	(PW to R.E. display is invalid) The CRC-Under error display is set to the reverse loop side and the PW to R.E. display is set to valid. (RUN to R.E. display is invalid)																																																																																	
		Switch position	Contents																																																																																						
L (F.L.)	The CRC-Under error display is set to the forward loop side and the RUN to R.E. display is set to valid.																																																																																								
R (R.L.)	(PW to R.E. display is invalid) The CRC-Under error display is set to the reverse loop side and the PW to R.E. display is set to valid. (RUN to R.E. display is invalid)																																																																																								
7*1	Conditions setting switch <table border="1" data-bbox="252 705 443 952"> <thead> <tr> <th>SW</th> <th>OFF</th> <th>ON</th> </tr> </thead> <tbody> <tr> <td>1</td> <td>PC</td> <td>REM.</td> </tr> <tr> <td>2</td> <td>N.ST D.S.M</td> <td>MNG P.S.M</td> </tr> <tr> <td>3</td> <td>PRM</td> <td>D.PRM</td> </tr> <tr> <td>4</td> <td colspan="2">ST.SIZE</td> </tr> <tr> <td>5</td> <td colspan="2">8. 16. 32. 64</td> </tr> <tr> <td>6</td> <td colspan="2">LS/LW SIZE</td> </tr> <tr> <td>7</td> <td colspan="2">2. 4. 6. 8k</td> </tr> <tr> <td>8</td> <td colspan="2"></td> </tr> </tbody> </table> OFF ON 	SW	OFF	ON	1	PC	REM.	2	N.ST D.S.M	MNG P.S.M	3	PRM	D.PRM	4	ST.SIZE		5	8. 16. 32. 64		6	LS/LW SIZE		7	2. 4. 6. 8k		8			Operation condition setting (factory setting at the time of shipping: all off)																																																												
		SW	OFF	ON																																																																																					
		1	PC	REM.																																																																																					
		2	N.ST D.S.M	MNG P.S.M																																																																																					
		3	PRM	D.PRM																																																																																					
		4	ST.SIZE																																																																																						
		5	8. 16. 32. 64																																																																																						
		6	LS/LW SIZE																																																																																						
		7	2. 4. 6. 8k																																																																																						
		8																																																																																							
<table border="1"> <thead> <tr> <th>SW</th> <th>Contents</th> <th colspan="4">OFF</th> <th colspan="4">ON</th> </tr> </thead> <tbody> <tr> <td>1</td> <td>Network type</td> <td colspan="4">PC Network</td> <td colspan="4">Remote I/O network</td> </tr> <tr> <td>2</td> <td>Station type</td> <td colspan="4">Normal station/ Multiple sub master</td> <td colspan="4">Control station/ parallel sub masters</td> </tr> <tr> <td>3</td> <td>Use parameters</td> <td colspan="4">Parameters in common</td> <td colspan="4">Default Parameters</td> </tr> <tr> <td>4</td> <td rowspan="2">Number of stations (Valid when SW3 is ON)</td> <td>OFF</td> <td>8 stations</td> <td>ON</td> <td>16 stations</td> <td>OFF</td> <td>32 stations</td> <td>ON</td> <td>64 stations</td> </tr> <tr> <td>5</td> <td>OFF</td> <td></td> <td>OFF</td> <td></td> <td>ON</td> <td></td> <td>ON</td> <td></td> </tr> <tr> <td>6</td> <td rowspan="2">B/W number of general point (Valid when SW3 is ON)</td> <td>OFF</td> <td>2K points</td> <td>ON</td> <td>4K points</td> <td>OFF</td> <td>6K points</td> <td>ON</td> <td>8K points</td> </tr> <tr> <td>7</td> <td>OFF</td> <td></td> <td>OFF</td> <td></td> <td>ON</td> <td></td> <td>ON</td> <td></td> </tr> <tr> <td>8</td> <td colspan="9">Not used (always off)</td> </tr> </tbody> </table>	SW	Contents	OFF				ON				1	Network type	PC Network				Remote I/O network				2	Station type	Normal station/ Multiple sub master				Control station/ parallel sub masters				3	Use parameters	Parameters in common				Default Parameters				4	Number of stations (Valid when SW3 is ON)	OFF	8 stations	ON	16 stations	OFF	32 stations	ON	64 stations	5	OFF		OFF		ON		ON		6	B/W number of general point (Valid when SW3 is ON)	OFF	2K points	ON	4K points	OFF	6K points	ON	8K points	7	OFF		OFF		ON		ON		8	Not used (always off)									
SW	Contents	OFF				ON																																																																																			
1	Network type	PC Network				Remote I/O network																																																																																			
2	Station type	Normal station/ Multiple sub master				Control station/ parallel sub masters																																																																																			
3	Use parameters	Parameters in common				Default Parameters																																																																																			
4	Number of stations (Valid when SW3 is ON)	OFF	8 stations	ON	16 stations	OFF	32 stations	ON	64 stations																																																																																
5		OFF		OFF		ON		ON																																																																																	
6	B/W number of general point (Valid when SW3 is ON)	OFF	2K points	ON	4K points	OFF	6K points	ON	8K points																																																																																
7		OFF		OFF		ON		ON																																																																																	
8	Not used (always off)																																																																																								
8	Connector	Connect the optical fiber cable. 																																																																																							

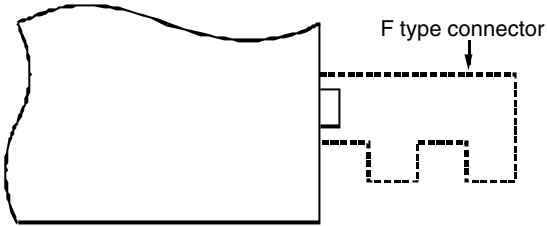
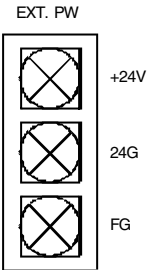
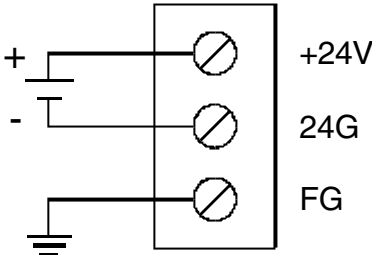
No.	Name	Contents
9	Connector	Connect the F type connector. 
A	External power source supply terminal 	When preventing loop pack by turning OFF the power source of the sequencer CPU, supply an external power source. 

- *1: When it is desired to change the setting while the Q2AS CPU power supply is ON, reset the Q2AS CPU (move the RUN/STOP key switch away from RESET to a position other than RESET).
- *2: When using by the remote I/O network, it becomes valid for station numbers 1 to 64.
- *3: Valid in the case of PC network management station.

4 Precautions Constructing a Coaxial Bus System

- (1) Cable length restrictions between stations. For coaxial cables which connect network modules, depending on the number of general stations, use the following lengths. When using cable lengths other than those shown in the chart to the left, a communications error may occur. However, general extension distance without the influence of the number of general stations is 500m (1641ft.).

Number of general stations	Cable length between stations
9 stations or less	1 to 500m (3 to 1641ft.)
10 stations or more	1 to 5m (3 to 16ft.) 13 to 17m (43 to 56ft.) 25 to 500m (82 to 1641ft.)

- (2) When using a A6BR10/A6BR10-DC type repeater module, use the between station cable length indicated under "10 or more stations," unconditionally, regardless of the number of stations connected.
- (3) Caution with wiring
- (a) Install the wiring keeping the coaxial cable at a distance of 100mm (0.328ft.) or more from other power cables and control cables.
- (b) In a location with excessive noise, examine wiring by double shield coaxial cable.

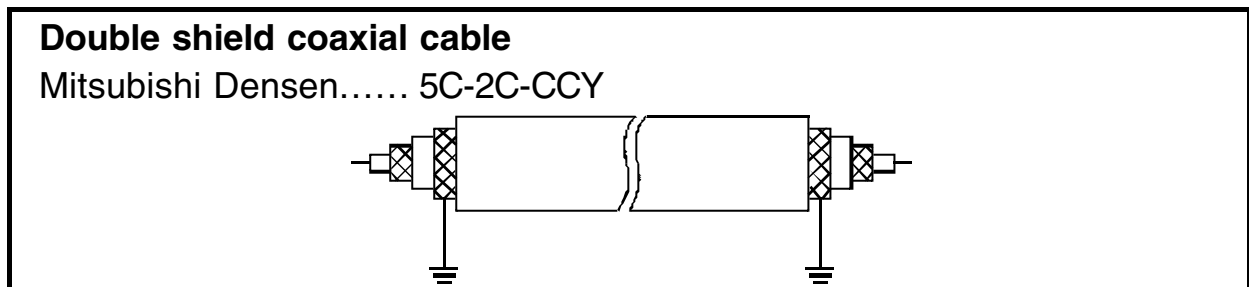

5 Handling

5.1. Cable length restrictions between stations.

- (1) The main modules case is made of plastic, so do not drop it or subject it to strong impacts.
- (2) Do not dismount the printed wiring board from the case. It may damage the module.
- (3) When wiring, be careful never to let foreign matter from the above module such as wiring scraps get inside the module. If something goes in, get rid of it.

(4) The module installation screw should be kept within the following range.

Screw Locations	Tightening Torque Range
Module installation screws (M4 screws)	78 to 117N•cm (8 to 12kg•cm)

6. Link Special Relay (SB)/Register (SW)

SB/SW where the data link data is stored are categorized by usage. Refer to the following tables when reading Section 6.1 on.

(1) Inter-PC network

(a) For the host information inquiry

Item	SB	SW
Host CPU status	SB004A SB004B	SW0043
Clear command status of each log area	SB0005 to 000B	—
Execution status for link dedicated command	SB0030 to 0038	SW0031 to 003F
Network module operation status	SB0020	SW0020
Network module setting status	SB0040 to 0044 BS0058 to 0069	SW0040 to 0046 SW0054 to 0068
Network module status	SB0047 to 0049	SW0047 to 004A

(b) For the total network information inquiry

Item	SB	SW
CPU status of each station (normal/error)	SB0080 SB0088	SW0080 to 0083 SW0088 to 008B
CPU operation status (RUN/STOP) of each station	SB0084	SW0084 to 0087
Cyclic transmission status of each station	SB0074	SW0074 to 0077
Link scan, communication mode	SB0068 SB0069	SW0068 to 008D
Network setting information	SB0064 to 0069	SW0054 to 0068
Network status	SB0070	SW0070 to 0073
Line status	SB0090 to 009A	SW0090 to 009A

(2) Remote I/O network

(a) For the host (remote master station) information inquiry

Item	SB	SW
Host CPU status	SB004A SB004B	SW004B
Clear command status of each log area	SB0005 to 000B	—
Network module operation status	SB0020	SW0020
Network module setting status	SB0040 to 0044 SB0058 to 0069	SW0040 to 0046 SW0054 to 0068
Network module status	SB0047 to 0049	SW0047 to 004A

(b) For the total network information inquiry

Item	SB	SW
Operation status of each station (normal/error)	SB0080	SW0080 to 0083
CPU operation status of remote master station (RUN/STOP)	SB0085	—
CPU operation status of remote submaster station (RUN/STOP)	SB0086	—
Cyclic transmission status of each station	SB0074 to 0076	SW0074 to 0077
Link scan, communication mode	SB0068 SB0069	SW0068 to 006D
Network setting information	SB0054 to 006C	SW0054 to 0068
Network status	SB0070	SW0070 to 0073
Line status	SB0090 to 009A	SW0090 to 009A

6.1 Link special relay (SB)

The link special relay controls the on/off from different causes during data link. The data error status can be obtained by using it in the sequence program or by monitoring.

The link special relay (SB) which stores the link status is used in the peripheral device network monitoring.

The SB on each network module is automatically refreshed to the following devices on Q2AS(H)CPU(-SI) depending on the number of modules:

1st module	2nd module	3rd module	4th module
SB0 to 1FF	SB200 to 3FF	SB400 to 5FF	SB600 to 7FF

Table 6.1 Link special relay list

Number	Name	Details	Device usage availability								
			Inter-PC network				Remote I/O network				
			Mp		Ns		Mr		R		
			Optical fiber	Coax	Optical fiber	Coax	Optical fiber	Coax	Optical fiber	Coax	
SB0000 (0)	Link startup (host)*1	Restarts the host cyclic transmission OFF: No startup command ON: Startup command exists (valid during startup) *2	b	b	b	b	b	b	b	b	b
SB0001 (1)	Link stop (host)*1	Stops host cyclic transmission OFF: No stop command ON: Stop command exists (valid during startup) *2	b	b	b	b	b	b	b	b	b
SB0002 (2)	System link startup *1	Cyclic transmission is restarted from the contents of SW0000 to SW0004. OFF: No startup command ON: Startup command exists (valid during startup) *2	b	b	b	b	b	b	b	b	b
SB0003 (3)	System link stop *1	Stops the cyclic transmission from the contents of SW0000 to SW0004 OFF: No stop command ON: Stop command exists (valid during startup) *2	b	b	b	b	b	b	b	b	b
SB0005 (5)	Number of retries clear	Number of retries (SW0008, SW0009) are cleared with "0". OFF: No clear command ON: Clear command exists (valid when ON)	b	b	b	b	b	b	b	b	b
SB0006 (6)	Number of communication errors clear *1	The communication error (SW00B8 to SW0007) are cleared with "0". OFF: No clear command ON: Clear command exists (valid when ON)	b	b	b	b	b	b	b	b	b
SB0007 (7)	Forward loop transmission error clear	Forward line error detection (SW0000) is cleared with "0". OFF: No clear command ON: Clear command exists	b	×	b	×	b	×	b	×	×

*1: Used in the peripheral device network testing.
*2: SB0000 to 3 are valid when only one point is on.

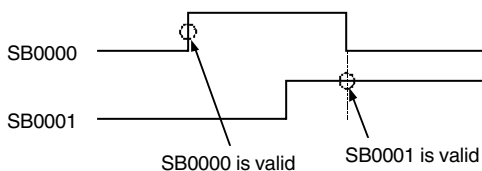

Table 6.1 Link special relay list (continued)

Number	Name	Details	Device usage availability							
			Inter-PC network				Remote I/O network			
			Mp		Ns		Mr		R	
			Optical fiber	Coax	Optical fiber	Coax	Optical fiber	Coax	Optical fiber	Coax
SB0008 (8)	Reverse loop transmission error clear	The reverse line error detection (SW00CD) is cleared with "0". OFF: No clear command ON: Clear specification exists (valid when on)	b	×	b	×	b	×	b	×
*2 SB0009 (9)	Number of loop switching clear	Number of loop switching (SW00E to E7) is cleared with "0". OFF: No clear command ON: Clear command exists (valid when on)	b	×	b	×	b	×	b	×
SB000A (10)	Transient transmission error clear	Transient transmission error (SW00EE, SW00EF) is cleared with "0". OFF: No clear command ON: Clear command exists (valid when on)	b	b	b	b	b	b	b	b
SB000B (11)	Transient transmission error area setting	Specifies the overwrite/maintain of the transient transmission error (SW00F0 to FF) OFF: Overwrite ON: Maintain	b	b	b	b	b	b	b	b
SB0020 (32)	Module status	Indicates the network module status OFF: Normal ON: Error	b	b	b	b	b	b	×	×
SB0030 (48)	ZNRD instruction acceptance	Indicates the ZNRD instruction receive status OFF: Not received ON: Received	b	b	b	b	b	b	×	×
	Send/receive (1) command	Indicates the acceptance status of SEND/RCV/READ/WRITE/REQ instructions (when using channel 1) OFF: Not accepted ON: Accepted/in progress								

*2: It is necessary to keep the SB0009 ON until the SW000E becomes 0.

Table 6.1 Link special relay list (continued)

Number	Name	Details	Device usage availability									
			Inter-PC network				Remote I/O network					
			Mp		Ns		Mr		R			
			Optical fiber	Coax	Optical fiber	Coax	Optical fiber	Coax	Optical fiber	Coax		
SB003 2 (50)	ZNWR instruction acceptance	Indicates the ZNRD instruction receive status OFF: Not received ON: Received										
	Send/receive (2) command	Indicates the acceptance status of SEND/RECV/READ/WRITE/REQ instructions (when using channel 2) OFF: Not accepted ON: Accepted/in progress	b	b	b	b	b	b	×	×		
SB003 4 (52)	Send/receive (3) command	Indicates the acceptance status of SEND/RECV/READ/WRITE/REQ instructions (when using channel 3) OFF: Not accepted ON: Accepted/in progress	b	b	b	b	b	b	×	×		
SB003 6 (54)	Send/receive (4) command	Indicates the acceptance status of SEND/RECV/READ/WRITE/REQ instructions (when using channel 4) OFF: Not accepted ON: Accepted/in progress	b	b	b	b	b	b	×	×		
SB003 8 (56)	Send/receive (5) command	Indicates the acceptance status of SEND/RECV/READ/WRITE/REQ instructions (when using channel 5) OFF: Not accepted ON: Accepted/in progress	b	b	b	b	b	b	×	×		
SB003 A (58)	Send/receive (6) command	Indicates the acceptance status of SEND/RECV/READ/WRITE/REQ instructions (when using channel 6) OFF: Not accepted ON: Accepted/in progress	b	b	b	b	b	b	×	×		

Table 6.1 Link special relay list (continued)

Number	Name	Details	Device usage availability							
			Inter-PC network				Remote I/O network			
			Mp		Ns		Mr		R	
			Optical fiber	Coax	Optical fiber	Coax	Optical fiber	Coax	Optical fiber	Coax
SB003C (60)	Send/receive (7) command	Accept status of SEND/RECV/READ/WRITE/REQ instructions (when using channel 7) is indicated. OFF: Not accepted ON: Accepted/in progress	b	b	b	b	b	b	×	×
SB003E (62)	Send/receive (8) command	Accept status of SEND/RECV/READ/WRITE/REQ instructions (when using channel 8) is indicated. OFF: Not accepted ON: Accepted/in progress	b	b	b	b	b	b	×	×
SB0040 (64)	Network type (host)	The network type set by the host network module switch is indicated. OFF: Inter-PC network ON: Remote I/O network	b	b	b	b	b	b	b	b
SB0042 (66)	Host power supply status	Host's external power supply status is indicated. OFF: No external power supply ON: External power supply exists	b	b	b	b	b	b	×	×
SB0043 (67)	Online switch (host)	The mode set by the host's network module switch is indicated. OFF: Online (Mode setting is "0".) ON: Not online (Mode setting is not "0".)	b	b	b	b	b	b	b	b

Table 6.1 Link special relay list (continued)

Number	Name	Details	Device usage availability							
			Inter-PC network				Remote I/O network			
			Mp		Ns		Mr		R	
			Optical fiber	Coax	Optical fiber	Coax	Optical fiber	Coax	Optical fiber	Coax
SB0044 (68)	Station setting (host)	The station type set by the host's network module switch is indicated. OFF: Normal station ON: Control station OFF: Remote I/O station ON: Remote master station Inter-PC network Remote I/O network	b	b	b	b	b	b	b	b
SB0047 (71)	Baton pass status	The baton-pass status of the host (transient transmission is possible) is indicated. OFF: Normal ON: Error	b	b	b	b	b	b	b	b
*3 SB0048 (72)	Control station status (inter-PC network)	The host status is indicated. (Valid when SB0047 is off.) OFF: Normal station ON: Control station (SB0044 is on.) Submanagement station (SB0042 is off.)	b	b	b	b	—	—	—	—
	Control station status (Remote I/O network)	Station controlling the baton pass (transient transmission is possible) is indicated. (Valid when SB0047 is OFF.) OFF: Remote I/O station ON: Remote master station (SB0044 is on.) Remote I/O station (SB0044 is off.)	—	—	—	—	b	b	b	b
*3 SB0049 (73)	Host data link status	Host data-link status is indicated. OFF: Normal ON: Error (Set after the refresh is complete.)	b	b	b	b	b	b	b	b
*3*4 SB004A (74)	Host CPU status (1)	Host CPU status is indicated. OFF: Normal ON: Minor error occurred	b	b	b	b	b	b	b	b

*3: Valid only when SB0047 is off (normal). When it is on (error), the previous data is maintained.

*4: A minor error is an error where the CPU operation status results in "continue" (such as battery error).

Table 6.1 Link special relay list (continued)

Number	Name	Details	Device usage availability								
			Inter-PC network				Remote I/O network				
			Mp		Ns		Mr		R		
			Optical fiber	Coax	Optical fiber	Coax	Optical fiber	Coax	Optical fiber	Coax	
*3*5 SB004 B (75)	Host CPU status (2)	Indicates the host CPU status. OFF: Normal ON: Mid to serious error occurred	b	b	b	b	b	b	b	b	b
*3 SB004 C (76)	Cyclic transmission startup acceptance status	The startup acceptance status of the cyclic transmission is indicated. OFF: Not accept received (SB0000 is off.) ON: Stop accept receive (SB0000 is on.)	b	b	b	b	b	b	b	b	b
*3 SB004 D (77)	Cyclic transmission startup complete status	Cyclic transmission completion status is indicated. OFF: Not complete (SB0000 is off.) ON: Startup complete (SB0000 is on.)	b	b	b	b	b	b	b	b	b
*3 SB004 E (78)	Cyclic transmission stop acceptance status	Cyclic transmission stop acceptance status is indicated. OFF: Not accepted (SB0001 is off.) ON: Stop accept (SB0001 is on.)	b	b	b	b	b	b	b	b	b
*3 SB004 F (79)	Cyclic transmission stop completion status	Cyclic stop completion status is indicated. OFF: Not complete (SB0001 is off.) ON: Stop complete (SB0001 is on.)	b	b	b	b	b	b	b	b	b
*3 SB005 0 (80)	Cyclic transmission startup acceptance status	Cyclic transmission startup acceptance status is indicated. OFF: Not accepted (SB0002 is off.) ON: Startup accepted (SB0002 is on.)	b	b	b	b	b	b	b	b	b
*3 SB005 1 (81)	Cyclic transmission startup completion status	Cyclic transmission completion status OFF: Not complete (SB0002 is off.) ON: Startup complete (SB0002 is on.)	b	b	b	b	b	b	b	b	b

*3: Valid only when SB0047 is off (normal). When it turns on (error), the previous data is stored.

*5: A middle-class error is when the CPU operation status turns to "stop" (such as WDT error).

A serious error is when the CPU operation status turns to "stop" (Such as RAM error). (Error code 11_{aa})

Table 6.1 Link special relay list (continued)

Number	Name	Details	Device usage availability								
			Inter-PC network				Remote I/O network				
			Mp		Ns		Mr		R		
			Optical fiber	Coax	Optical fiber	Coax	Optical fiber	Coax	Optical fiber	Coax	
*3 SB005 2 (82)	Cyclic transmission stop acceptance status	Cyclic transmission stop acceptance status is indicated. OFF: Not accepted (SB0003 is off.) ON: Startup accepted (SB0003 is on.)	b	b	b	b	b	b	b	b	b
*3 SB005 3 (83)	Cyclic transmission stop completion status	Cyclic transmission stop completion status is indicated. OFF: Not complete (SB0003 is off.) ON: Stop complete (SB0003 is on.)	b	b	b	b	b	b	b	b	b
*3 SB005 4 (84)	Parameter acceptance status	Parameter receive status is indicated. OFF: Receive complete ON: Not received	b	b	b	b	b	b	b	b	b
*3 SB005 5 (85)	Received parameter error	The received parameter status is indicated. OFF: Parameter normal ON: Parameter error	b	b	b	b	b	b	b	b	b
*3 SB005 6 (86)	Communication status	Transient transmission status is indicated. (Valid when SB0047 is off.) OFF: Transient transmission by the control station (remote master station) ON: Transient transmission by the subcontrol station (other than remote master station)	b	b	b	b	b	b	b	b	b
*3 SB005 8 (88)	Sub-control station link	Cyclic transmission status when the control station is down is indicated. OFF: Cyclic transmission at the subcontrol station exists ON: No cyclic transmission at the submanagement station	b	b	b	b	b	b	b	b	b
*3 SB005 C (92)	I/O master station (block 1)	Block 1's I/O master station setting (common parameter setting) is indicated. (Valid when SB0049 is off.) OFF: No setting ON: Setting exists. (Station number is stored in SW0050.)	b	b	b	b	×	×	×	×	×

*3: Valid only when SB0047 is off (normal). When it turns on (error), the previous data is stored.

Table 6.1 Link special relay list (continued)

Number	Name	Details	Device usage availability							
			Inter-PC network				Remote I/O network			
			Mp		Ns		Mr		R	
			Optical fiber	Coax	Optical fiber	Coax	Optical fiber	Coax	Optical fiber	Coax
*3 SB005D (93)	I/O master station (block 2)	The I/O master station setting (common parameter setting) for block 2 is indicated. (Valid when SB0049 is off.) OFF: No setting ON: Setting exists (Station number is stored in SW005D.)	b	b	b	b	×	×	×	×
*3 SB0064 (100)	Reserved station specification	The reserved station specification is indicated. (Valid when SB0049 is off.) OFF: None ON: Exists Turns off when all SW0064 to 67 are "0".	b	b	b	b	b	b	b	b
*3 SB0068 (104)	Communication mode	Link scan mode (common parameter extended setting status) is indicated. (Valid when SB0049 is off.) OFF: Normal mode ON: Constant scan mode	b	b	b	b	b	b	b	b
*3 SB0069 (105)	Multiplex transmission specification	Transmission specification status (common parameter extended setting status) is indicated. (Valid when SB0049 is off.) OFF: Normal transmission specification ON: Multiplex transmission specification	b	×	b	×	b	×	b	×
*3 SB006A (106)	Multiplex transmission status	The transmission status is indicated. OFF: Normal transmission in progress ON: Multiplex transmission in progress	b	×	b	×	b	×	b	×
*3 SB006B (107)	Multiplex/parallel function specification	Multiple master/parallel master function specification status is indicated. OFF: No setting ON: Setting exists	×	×	×	×	b	b	b	b
*3 SB006C (108)	Multiplex/parallel function status	Multiple master/parallel master function status is indicated. OFF: Multiple master ON: Parallel master	×	×	×	×	b	b	b	b

*3: Valid only when SB0047 is off (normal). When it turns on (error), the previous data is maintained.

Table 6.1 Link special relay list (continued)

Number	Name	Details	Device usage availability							
			Inter-PC network				Remote I/O network			
			Mp		Ns		Mr		R	
			Optical fiber	Coax	Optical fiber	Coax	Optical fiber	Coax	Optical fiber	Coax
*3 SB006 D (109)	Communication status with the master station	The cyclic transmission status with the parallel remote master station is indicated. OFF: No cyclic transmission ON: Cyclic transmission exists	×	×	×	×	×	×	b	b
*3 SB006 E (110)	Communication status with the sub-master station	The cyclic transmission status with the parallel remote submaster station is indicated. OFF: No cyclic transmission ON: Cyclic transmission exists	×	×	×	×	×	×	b	b
*3 SB007 0 (112)	Baton pass status at each station	The baton-pass status of each station is indicated. (Reserved stations, stations beyond maximum station number not included.) OFF: All stations normal ON: Faulty station exists. Off when SW0070 to 73 are all "0".	b	b	b	b	b	b	b	b
*3 SB007 1 (113)	Master station transient transmission status	The transient transmission status of the remote master station is indicated. OFF: Normal ON: Error	×	×	×	×	b	b	b	b
*3 SB007 2 (114)	Sub-master station transient transmission status	The transient transmission status of the remote submaster station is indicated. OFF: Normal ON: Error	×	×	×	×	b	b	b	b
*3 SB007 4 (116)	Cyclic transmission status at each station	The cyclic transmission status of each station is indicated. (Reserved stations, stations beyond maximum station number not included.) OFF: Data link at all stations ON: Stations not executing data link exists. Off when SW0074 to 77 are all "0".	b	b	b	b	b	b	b	b

*3: Valid only when SB0047 is off (normal). When it turns on (error), the previous data is maintained.

Table 6.1 Link special relay list (continued)

Number	Name	Details	Device usage availability							
			Inter-PC network				Remote I/O network			
			Mp		Ns		Mr		R	
			Optical fiber	Coax	Optical fiber	Coax	Optical fiber	Coax	Optical fiber	Coax
*3 SB0075 (117)	Master station cyclic transmission status	Remote master station's cyclic transmission status is indicated. OFF: Normal ON: Error	×	×	×	×	b	b	b	b
*3 SB0076 (118)	Sub-master station cyclic transmission status	Remote submaster station's cyclic transmission status is indicated. (Valid when SB006B is on.) OFF: Normal ON: Error	×	×	×	×	b	b	b	b
*3 SB0077 (119)	Master station cyclic transmission control status	The station controlling the cyclic transmission is indicated. (Valid when SB006B is on.) OFF: Controlled by the remote master station ON: Controlled by the remote submaster station	×	×	×	×	b	b	b	b
*3 SB0078 (120)	Parameter status for each station	The parameter communication status for each station is indicated. (Reserved stations, stations beyond maximum station number not included.) OFF: Not in parameter communication ON: In parameter communication Off when all SW0078 to 7B are all "0".	b	b	×	×	b	b	×	×
*3 SB007C (124)	Parameter status for each station	The parameter status of each station is indicated. (Reserved stations, stations beyond maximum station number not included.) OFF: No station detected parameter error. ON: Station which detected parameter error exists. Off when all SW0070 to 7F are all "0".	b	b	×	×	b	b	×	×

*3: Valid only when SB0047 is off (normal). When it turns on (error), the previous data is maintained.

Table 6.1 Link special relay list (continued)

Number	Name	Details	Device usage availability							
			Inter-PC network				Remote I/O network			
			Mp		Ns		Mr		R	
			Optical fiber	Coax	Optical fiber	Coax	Optical fiber	Coax	Optical fiber	Coax
*3 SB0080 (128)	CPU operation status for each station *5	CPU operation status of each station is indicated (including host). OFF: No station with mid to serious error ON: Station with mid to serious major error exists Off when all SW0080 to 83 are all "0".	b	b	b	b	×	×	×	×
	Remote I/O station status	Remote I/O station status is indicated (including host). OFF: All stations normal ON: Faulty station exists. Off when all SW0080 to 83 are all "0".	×	×	×	×	b	b	b	b
*3 SB0084 (132)	CPU RUN status for each station	CPU RUN status of each station is indicated. OFF: All stations at RUN or STEP RUN state. ON: Stations at STOP or PAUSE status exists (including host). Off when all SW0084 to 87 are all "0".	b	b	b	b	×	×	×	×
*3 SB0085 (133)	Master station CPU status	Remote master station CPU status is indicated. OFF: RUN, STEP RUN ON: STOP, PAUSE	×	×	×	×	b	b	b	b
*3 SB0086 (134)	Sub-master station CPU status	Remote submaster station CPU status is indicated. OFF: RUN, STEP RUN ON: STOP, PAUSE	×	×	×	×	b	b	b	b
*3 SB0088 (136)	CPU operation status for each station *7	CPU operation status of each station is indicated (including host). OFF: No station with minor error ON: Station with minor error exists Off when all SW0088 to 8B are all "0".	b	b	b	b	b	b	b	b

*3: Valid only when SB0047 is off (normal). When it turns on (error), the previous data is maintained.

*5: A middle-class error is when the CPU operation status turns to "stop" (such as WDT error).

A major error is when the CPU operation status turns to "stop" (Such as RAM error). (Error code 11_{aa})

*7: A minor error is when the CPU operation status results in "continue" (such as a battery error).

Table 6.1 Link special relay list (continued)

Number	Name	Details	Device usage availability							
			Inter-PC network				Remote I/O network			
			Mp		Ns		Mr		R	
			Optical fiber	Coax	Optical fiber	Coax	Optical fiber	Coax	Optical fiber	Coax
*3 SB008 C (140)	External power existence information	External power supply information is indicated (including host). OFF: No external power supply for all stations ON: Station with external power supply exists Off when all SW0088 to 8B are all "0".	b	b	b	b	b	b	b	b
*3 SB009 0 (144)	Host loop status	The host loop status is indicated. OFF: Normal ON: Error Turns off when SW0090 is "0".	b	×	b	×	b	×	b	×
*3 SB009 1 (145)	Forward loop status	The status of the stations connected to the forward loop is indicated. OFF: All stations normal ON: Faulty station exists. Turns off when SW0091 to 94 are all "0".	b	×	b	×	b	×	b	×
*3 SB009 2 (146)	Master station forward loop status	Remote master station's forward loop status is indicated. OFF: Normal ON: Error	×	×	×	×	×	×	b	×
*3 SB009 5 (149)	Reverse loop status	The status of the stations connected to the reverse loop is indicated. OFF: All stations normal ON: Faulty station exists. Turns off when SW0095 to 98 are all "0".	b	×	b	×	b	×	b	×
*3 SB009 6 (150)	Master station reverse loop status	Remote master station's reverse loop status is indicated. OFF: Normal ON: Error	×	×	×	×	×	×	b	×

*3: Valid only when SB0047 is off (normal). When it turns on (error), the previous data is maintained.

Table 6.1 Link special relay list (continued)

Number	Name	Details	Device usage availability							
			Inter-PC network				Remote I/O network			
			Mp		Ns		Mr		R	
			Optical fiber	Coax	Optical fiber	Coax	Optical fiber	Coax	Optical fiber	Coax
*3 SB0099 (153)	Forward loop loop-back	The loop-back status of the forward loop in the system is indicated. OFF: No loop backs ON: Station in loop back exists. (The station in the loop back is stored in SW0099.)	b	×	b	×	b	×	b	×
*3 SB009A (154)	Reverse loop loop-back	The loop back status of the reverse loop in the system is indicated. OFF: No loop backs ON: Station in loop back exists (Station in the loop back is stored in SW009A.)	b	×	b	×	b	×	b	×
*3 SB00A0 (160)	RECV instruction execution request flag (1)	RECV instruction execution request status indicated. (Channel 1) OFF: No execution request exists ON: Execution request exists	b	b	b	b	b	b	×	×
*3 SB00A1 (161)	RECV instruction execution request flag (2)	RECV instruction execution request status indicated. (Channel 2) OFF: No execution request exists ON: Execution request exists	b	b	b	b	b	b	×	×
*3 SB00A2 (162)	RECV instruction execution request flag (3)	RECV instruction execution request status indicated. (Channel 3) OFF: No execution request exists ON: Execution request exists	b	b	b	b	b	b	×	×
*3 SB00A3 (163)	RECV instruction execution request flag (4)	RECV instruction execution request status indicated. (Channel 4) OFF: No execution request exists ON: Execution request exists	b	b	b	b	b	b	×	×
*3 SB00A4 (164)	RECV instruction execution request flag (5)	RECV instruction execution request status indicated. (Channel 5) OFF: No execution request exists ON: Execution request exists	b	b	b	b	b	b	×	×
*3 SB00A5 (165)	RECV instruction execution request flag (6)	RECV instruction execution request status indicated. (Channel 6) OFF: No execution request exists ON: Execution request exists	b	b	b	b	b	b	×	×

*3: Valid only when SB0047 is off (normal). When it turns on (error), the previous data is maintained.

Table 6.1 Link special relay list (continued)

Number	Name	Details	Device usage availability							
			Inter-PC network				Remote I/O network			
			Mp		Ns		Mr		R	
			Optical fiber	Coax	Optical fiber	Coax	Optical fiber	Coax	Optical fiber	Coax
*3 SB00A 6 (166)	RECV instruction execution request flag (7)	RECV instruction execution request status indicated. (Channel 7) OFF: No execution request ON: Execution request exists	b	b	b	b	b	b	×	×
*3 SB00A 7 (167)	RECV instruction execution request flag (8)	RECV instruction execution request status indicated. (Channel 8) OFF: No execution request ON: Execution request exists	b	b	b	b	b	b	×	×
*3 SB00A 8 (168)	Online test specification	The online test specification status is indicated. OFF: Not specified ON: Specified	b	b	b	b	b	b	b	b
*3 SB00A 9 (169)	Online test complete	Online test completion status is indicated. OFF: Not complete ON: Complete	b	b	b	b	b	b	b	b
*3 SB00A A (170)	Online test response specification	Online test response status is indicated. OFF: No response ON: Response complete	b	b	b	b	b	b	b	b
*3 SB00A B (171)	Online test response complete	Online test response completion status is indicated. OFF: No response complete ON: Response complete	b	b	b	b	b	b	b	b

*3: Valid only when SB0047 is off (normal). When it turns on (error), the previous data is maintained.

Table 6.1 Link special relay list (continued)

Number	Name	Details	Device usage availability								
			Inter-PC network				Remote I/O network				
			Mp		Ns		Mr		R		
			Optical fiber	Coax	Optical fiber	Coax	Optical fiber	Coax	Optical fiber	Coax	
*3 SB00AC (172)	Offline test specification	Offline test specification status is indicated. OFF: Not specified ON: Specified	b	b	b	b	b	b	b	b	b
*3 SB00AD (173)	Offline test complete	Offline test completion status is indicated. OFF: Not complete ON: Complete	b	b	b	b	b	b	b	b	b
*3 SB00AE (174)	Offline test response specification	Offline test response status is indicated. OFF: No response ON: Response	b	b	b	b	b	b	b	b	b
*3 SB00AF (175)	Offline test response complete	Offline test response completion status is indicated. OFF: No response complete ON: Response complete	b	b	b	b	b	b	b	b	b
*3 SB00EE (238)	Transient error	Error status of the transient transmission is indicated. OFF: No error ON: Error exists	b	b	b	b	b	b	b	b	b
*3 SB01F0 (496)	User-free flag status	User-flag status is indicated. (Reserved stations and stations beyond the max. station number are not included.) OFF: All user flags are off ON: Turned on user-flag exists Off when SW01F0 to 1F3 are all "0".	b	b	b	b	×	×	×	×	×

*3: Valid only when SB0047 is off (normal). When it turns on (error), the previous data is maintained.

6.2 Link special register (SW)

The link special registers store the information during data link in numeric values.

By monitoring these registers, the erroneous areas and causes can be investigated.

The link special registers (SW) that store the link status are used by the peripheral device network monitor.

The SW for each network module is refreshed automatically to the Q2AS(H)CPU(-SI) device shown below, depending on the number of modules:

1st module	2nd module	3rd module	4th module
SW0 to 1FF	SW200 to 3FF	SW400 to 5FF	SW600 to 7FF

Table 6.2 Link special register list

Number	Name	Details	Device usage availability																																																														
			Inter-PC network				Remote I/O network																																																										
			Mp		Ns		Mr		R																																																								
			Optical fiber	Coax	Optical fiber	Coax	Optical fiber	Coax	Optical fiber	Coax																																																							
SW0000 (0)	Link stop/startup specification details *1	Station to stop/restart the data link is set. 00H: Host 01H: All stations 02H: Specified station 80H: Host (forced stop/restart) 81H: All stations (forced stop/restart) 82H: Specified station (forced stop/restart)	b	b	b	b	b	b	b	b																																																							
SW0001 (1) • SW0002 (2) • SW0003 (3) • SW0004 (4)	Link stop/startup specification details *1	Set for specified station. (When SW000 is 02H or B2H.) Set the bit for the station in which data link will be stopped/restarted to "1". 0: Data link stop/restart specification invalid 1: Data link stop/restart specification valid <table border="1" style="font-size: small;"> <tr> <td></td> <td>b15</td> <td>b14</td> <td>b13</td> <td>b12</td> <td>to</td> <td>b4</td> <td>b3</td> <td>b2</td> <td>b1</td> <td>b0</td> </tr> <tr> <td>SW0001</td> <td>16</td> <td>15</td> <td>14</td> <td>13</td> <td>to</td> <td>5</td> <td>4</td> <td>3</td> <td>2</td> <td>1</td> </tr> <tr> <td>SW0002</td> <td>32</td> <td>31</td> <td>30</td> <td>29</td> <td>to</td> <td>21</td> <td>20</td> <td>19</td> <td>18</td> <td>17</td> </tr> <tr> <td>SW0003</td> <td>48</td> <td>47</td> <td>46</td> <td>45</td> <td>to</td> <td>37</td> <td>36</td> <td>35</td> <td>34</td> <td>33</td> </tr> <tr> <td>SW0004</td> <td>64</td> <td>63</td> <td>62</td> <td>61</td> <td>to</td> <td>53</td> <td>52</td> <td>51</td> <td>50</td> <td>49</td> </tr> </table> <small>1 to 64 in the table indicates station numbers.</small>		b15	b14	b13	b12	to	b4	b3	b2	b1	b0	SW0001	16	15	14	13	to	5	4	3	2	1	SW0002	32	31	30	29	to	21	20	19	18	17	SW0003	48	47	46	45	to	37	36	35	34	33	SW0004	64	63	62	61	to	53	52	51	50	49	b	b	b	b	b	b	b	b
	b15	b14	b13	b12	to	b4	b3	b2	b1	b0																																																							
SW0001	16	15	14	13	to	5	4	3	2	1																																																							
SW0002	32	31	30	29	to	21	20	19	18	17																																																							
SW0003	48	47	46	45	to	37	36	35	34	33																																																							
SW0004	64	63	62	61	to	53	52	51	50	49																																																							
SW0020 (32)	Module status	The network module status is stored. 0: Normal 1 to: Error (Refer to Chapter 9 for error codes.) FF: Module error	b	b	b	b	b	b	×	×																																																							
SW0031 (49)	ZNRD instruction processing result	ZNRD instruction processing result is indicated. 0: Normal completion 1 to: Error completion (Refer to Chapter 9 for error codes.)																																																															
	Send/receive instruction (1) processing result	SEND/RECV/READ/WRITE/REQ instruction (when channel 1 is used processing result is indicated. 0: Normal completion 1 to: Error completion (Refer to Chapter 9 for error codes.)	b	b	b	b	b	b	×	×																																																							

*1: Used in the peripheral device network testing.

Table 6.2 Link special register list (continued)

Number	Name	Details	Device usage availability							
			Inter-PC network				Remote I/O network			
			Mp		Ns		Mr		R	
			Optical fiber	Coax	Optical fiber	Coax	Optical fiber	Coax	Optical fiber	Coax
SW0033 (51)	ZNWR instruction processing result	ZNWR instruction processing result is indicated. 0: Normal completion 1 to: Error completion (Refer to Chapter 9 for error codes.)	b	b	b	b	b	b	×	×
	Send/receive instruction (2) processing result	SEND/RECV/READ/WRITE/REQ instruction (when using channel 2) processing result is indicated. 0: Normal completion 1 to: Error completion (Refer to Chapter 9 for error codes.)	b	b	b	b	b	b	×	×
SW0035 (53)	Send/receive instruction (3) processing result	SEND/RECV/READ/WRITE/REQ instruction (when using channel 3) processing result is indicated. 0: Normal completion 1 to: Error completion (Refer to Chapter 9 for error codes.)	b	b	b	b	b	b	×	×
SW0037 (55)	Send/receive instruction (4) processing result	SEND/RECV/READ/WRITE/REQ instruction (when using channel 4) processing result is indicated. 0: Normal completion 1 to: Error completion (Refer to Chapter 9 for error codes.)	b	b	b	b	b	b	×	×
SW0039 (57)	Send/receive instruction (5) processing result	SEND/RECV/READ/WRITE/REQ instruction (when using channel 5) processing result is indicated. 0: Normal completion 1 to: Error completion (Refer to Chapter 9 for error codes.)	b	b	b	b	b	b	×	×
SW003B (59)	Send/receive instruction (6) processing result	SEND/RECV/READ/WRITE/REQ instruction (when using channel 6) processing result is indicated. 0: Normal completion 1 to: Error completion (Refer to Chapter 9 for error codes.)	b	b	b	b	b	b	×	×

Table 6.2 Link special register list (continued)

Number	Name	Details	Device usage availability																													
			Inter-PC network				Remote I/O network																									
			Mp		Ns		Mr		R																							
			Optical fiber	Coax	Optical fiber	Coax	Optical fiber	Coax	Optical fiber	Coax																						
SW003D (61)	Send/receive instruction (7) processing result	SEND/RECV/READ/WRITE/REQ instruction (when using channel 7) processing result is indicated. 0: Normal completion 1 to: Error completion (Refer to Chapter 9 for error codes.)	b	b	b	b	b	b	×	×																						
SW003F (63)	Send/receive instruction (8) processing result	SEND/RECV/READ/WRITE/REQ instruction (when using channel 8) processing result is indicated. 0: Normal completion 1 to: Error completion (Refer to Chapter 9 for error codes.)	b	b	b	b	b	b	×	×																						
SW0040 (64)	Network number	Host network number is stored. Range: 1 to 239	b	b	b	b	b	b	b	b																						
SW0041 (65)	Group number	Host group number is stored. 0: No group specification 1 to 9: Group number	b	b	b	b	×	×	×	×																						
SW0042 (66)	Station number	Host station number is stored. Range: 1 to 64 70H: Remote master station	b	b	b	b	b	b	b	b																						
SW0043 (67)	Online switch	Host mode switch status is stored. Range: 0H to FH	b	b	b	b	b	b	b	b																						
SW0044 (68)	Station setting	Host condition setting switch status is stored. 0: OFF 1: ON <table border="1" style="margin-left: 20px;"> <tr> <td>b15 to</td><td>b8</td><td>b7</td><td>b6</td><td>b5</td><td>b4</td><td>b3</td><td>b2</td><td>b1</td><td>b0</td> </tr> <tr> <td>SW0044</td><td>0</td><td>to</td><td>0</td><td>8</td><td>7</td><td>6</td><td>5</td><td>4</td><td>3</td><td>2</td><td>1</td> </tr> </table> <div style="margin-left: 20px; border: 1px solid black; padding: 2px; display: inline-block;"> 1 to 8 in the table indicates the SW number. </div>	b15 to	b8	b7	b6	b5	b4	b3	b2	b1	b0	SW0044	0	to	0	8	7	6	5	4	3	2	1	b	b	b	b	b	b	b	b
b15 to	b8	b7	b6	b5	b4	b3	b2	b1	b0																							
SW0044	0	to	0	8	7	6	5	4	3	2	1																					

Table 6.2 Link special register list (continued)

Number	Name	Details	Device usage availability							
			Inter-PC network				Remote I/O network			
			Mp		Ns		Mr		R	
			Optical fiber	Coax	Optical fiber	Coax	Optical fiber	Coax	Optical fiber	Coax
SW0046 (70)	Module ID	<p>Stores the type of the host network module.</p>	b	b	b	b	b	b	b	b
SW0047 (71)	Baton pass status	<p>Stores the baton-pass status of the host</p> <ul style="list-style-type: none"> 0: Data link in progress 1: Data link stopped (by another station) 2: Data link stopped (by host) 3: Batonpass in progress (parameter received) 4: Batonpass in progress (parameter received) 5: Batonpass in progress (parameter not received) 6: Disconnected from network (no baton pass) 7: Disconnected from network (line error) 11H: Loop test 12H: Setting confirmation test 13H: Station order confirmation test 14H: communication test 1FH: Offline test FFH: Resetting 	b	b	b	b	b	b	b	b

Table 6.2 Link special relay list (continued)

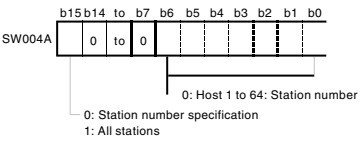
Number	Name	Details	Device usage availability								
			Inter-PC network				Remote I/O network				
			Mp		Ns		Mr		R		
			Optical fiber	Coax	Optical fiber	Coax	Optical fiber	Coax	Optical fiber	Coax	
SW0048 (72)	Baton pass interrupt cause	Stores the baton-pass interruption cause for host 0: Normal communication 1: Offline 2: Offline test 3 to: Interrupt cause (Refer to Chapter 9.)	b	b	b	b	b	b	b	b	b
*2 SW0049 (73)	Data link transmission stop cause	Stores the cause for the host data link stop. 0: Normal 1: Stop specified 2: No common parameter 3: Common parameter error 4: Host CPU error 6: Communication interrupt	b	b	b	b	b	b	b	b	b
*2 SW004A (74)	Data link stop request station	Stores the station which stopped the host data link (Valid when SW0049 is "1".) 	b	b	b	b	b	b	b	b	b

*2: Valid only when SB0047 is off (normal). When it turns on (error), the previous data is maintained.

Table 6.2 Link special register list (continued)

Number	Name	Details	Device usage availability								
			Inter-PC network				Remote I/O network				
			Mp		Ns		Mr		R		
			Optical fiber	Coax	Optical fiber	Coax	Optical fiber	Coax	Optical fiber	Coax	
*2 SW004 B (75)	Host CPU status	Host CPU status is indicated. 0: Normal 1 to: Error (Refer to Chapter 9 for error codes.)	b	b	b	b	b	b	b	b	b
*2 SW004 C (76)	Host CPU error slot number	The slot number of the host where error occurred is stored. (Valid when SW004B is not "0".)	×	×	×	×	×	×	b	b	b
*2 SW004 D (77)	Data link startup status (host)	Data link startup result is stored. 0: Normal 1 to: Error (Refer to Chapter 9 for error codes.)	b	b	b	b	b	b	b	b	b
*2 SW004 F (79)	Data link stop status (host)	Data link stop result is stored. 0: Normal 1 to: Error (Refer to Chapter 9 for error codes.)	b	b	b	b	b	b	b	b	b
*2 SW005 1 (81)	Data link startup status (whole system)	Data link startup result is stored. 0: Normal 1 to: Error (Refer to Chapter 9 for error codes.)	b	b	b	b	b	b	b	b	b
*2 SW005 3 (83)	Data link stop status (whole system)	Data link stop result is stored. 0: Normal 1 to: Error (Refer to Chapter 9 for error codes.)	b	b	b	b	b	b	b	b	b
*2 SW005 4 (84)	Parameter (1)	The parameter information is stored. (Valid when SB0054 and SB0055 are off.) 0: Used only for common parameters 1: Common parameter + station-specific parameters 2: Used only for default parameters 3: Default parameters + station-specific parameters	b	b	b	b	×	×	×	×	×
*2 SW005 5 (85)	Parameter (2)	The parameter status is stored. 0: Parameter normal 1 to: Parameter error	b	b	b	b	b	b	b	b	b

*2: Valid only when SB0047 is off (normal). When it turns on (error), the previous data is maintained.

Table 6.2 Link special register list (continued)

Number	Name	Details	Device usage availability							
			Inter-PC network				Remote I/O network			
			Mp		Ns		Mr		R	
			Optical fiber	Coax	Optical fiber	Coax	Optical fiber	Coax	Optical fiber	Coax
*2 SW0056 (86)	Current control station	The station number of the station actually taking the control station role is stored (including subcontrol station). Range: 1 to 64	b	b	b	b	—	—	—	—
	Current master station	The station number of the station controlling the baton-pass is stored. 7DH: Remote master station Other than 7DH: Station number of controlling station	—	—	—	—	b	b	b	b
*2 SW0057 (87)	Specified control station	The station number set as the control station is stored. Range: 1 to 64 0: Specified control station error	b	b	b	b	—	—	—	—
	Specified master station	7DH: Remote master station 0: Remote master station	—	—	—	—	b	b	b	b
*2 SW0059 (89)	Total number of linked stations	The total number of linked stations set in the parameter is stored. Range: 1 to 64 (64 when parameter does not exist.)	b	b	b	b	b	b	b	b
*2 SW005A (90)	Max. station number in normal baton-pass stations	The maximum station number performing normal baton-pass is stored. Range: 1 to 64	b	b	b	b	b	b	b	b
*2 SW005B (91)	Max. station number in cyclic transmission stations	The maximum station number performing cyclic transmission is stored. Range: 1 to 64	b	b	b	b	b	b	b	b

*2: Valid only when SB0047 is off (normal). When it turns on (error), the previous data is maintained.

Table 6.2 Link special register list (continued)

Number	Name	Details	Device usage availability																																																														
			Inter-PC network				Remote I/O network																																																										
			Mp		Ns		Mr		R																																																								
			Optical fiber	Coax	Optical fiber	Coax	Optical fiber	Coax	Optical fiber	Coax																																																							
*2 SW005 C (92)	I/O master station (block 1)	The station number of block I/O master station is stored. 0: None 1 to 64: Station number Valid when SB0049 is off.	b	b	b	b	×	×	×	×																																																							
*2 SW005 D (93)	I/O master station (block 2)	Station number of block 2's I/O master station is stored. 0: None 1 to 64: Station number Valid when SB0049 is off.	b	b	b	b	×	×	×	×																																																							
*2 SW006 0 (96) • SW006 1 (97) • SW006 2 (98) • SW006 3 (99)	Cyclic transmission control status	<p>The status of whether the controlling station (parallel remote master station/parallel remote submaster station) is the same station as the host. 0: Same as host 1: Different from host</p> <table border="1"> <tr> <td></td> <td>b15</td> <td>b14</td> <td>b13</td> <td>b12</td> <td>to</td> <td>b4</td> <td>b3</td> <td>b2</td> <td>b1</td> <td>b0</td> </tr> <tr> <td>SW0060</td> <td>16</td> <td>15</td> <td>14</td> <td>13</td> <td>to</td> <td>5</td> <td>4</td> <td>3</td> <td>2</td> <td>1</td> </tr> <tr> <td>SW0061</td> <td>32</td> <td>31</td> <td>30</td> <td>29</td> <td>to</td> <td>21</td> <td>20</td> <td>19</td> <td>18</td> <td>17</td> </tr> <tr> <td>SW0062</td> <td>48</td> <td>47</td> <td>46</td> <td>45</td> <td>to</td> <td>37</td> <td>36</td> <td>35</td> <td>34</td> <td>33</td> </tr> <tr> <td>SW0063</td> <td>64</td> <td>63</td> <td>62</td> <td>61</td> <td>to</td> <td>53</td> <td>52</td> <td>51</td> <td>50</td> <td>49</td> </tr> </table> <p>1 to 64 in the table indicates the station number.</p>		b15	b14	b13	b12	to	b4	b3	b2	b1	b0	SW0060	16	15	14	13	to	5	4	3	2	1	SW0061	32	31	30	29	to	21	20	19	18	17	SW0062	48	47	46	45	to	37	36	35	34	33	SW0063	64	63	62	61	to	53	52	51	50	49	×	×	×	×	b	b	b	b
	b15	b14	b13	b12	to	b4	b3	b2	b1	b0																																																							
SW0060	16	15	14	13	to	5	4	3	2	1																																																							
SW0061	32	31	30	29	to	21	20	19	18	17																																																							
SW0062	48	47	46	45	to	37	36	35	34	33																																																							
SW0063	64	63	62	61	to	53	52	51	50	49																																																							

*2: Valid only when SB0047 is off (normal). When it turns on (error), the previous data is maintained.

Table 6.2 Link special register list (continued)

Number	Name	Details	Device usage availability																																																														
			Inter-PC network				Remote I/O network																																																										
			Mp		Ns		Mr		R																																																								
			Optical fiber	Coax	Optical fiber	Coax	Optical fiber	Coax	Optical fiber	Coax																																																							
*2 SW0064 (100) • SW0065 (101) • SW0066 (102) • SW0067 (103)	Reserved station specification	The station set as the reserved station is stored. 0: Not reserved station 1: Reserved station Valid when SB0049 is off. <table border="1"> <tr> <td></td><td>b15</td><td>b14</td><td>b13</td><td>b12</td><td>to</td><td>b4</td><td>b3</td><td>b2</td><td>b1</td><td>b0</td> </tr> <tr> <td>SW0064</td><td>16</td><td>15</td><td>14</td><td>13</td><td>to</td><td>5</td><td>4</td><td>3</td><td>2</td><td>1</td> </tr> <tr> <td>SW0065</td><td>32</td><td>31</td><td>30</td><td>29</td><td>to</td><td>21</td><td>20</td><td>19</td><td>18</td><td>17</td> </tr> <tr> <td>SW0066</td><td>48</td><td>47</td><td>46</td><td>45</td><td>to</td><td>37</td><td>36</td><td>35</td><td>34</td><td>33</td> </tr> <tr> <td>SW0067</td><td>64</td><td>63</td><td>62</td><td>61</td><td>to</td><td>53</td><td>52</td><td>51</td><td>50</td><td>49</td> </tr> </table> 1 to 64 in the table indicates the station number.		b15	b14	b13	b12	to	b4	b3	b2	b1	b0	SW0064	16	15	14	13	to	5	4	3	2	1	SW0065	32	31	30	29	to	21	20	19	18	17	SW0066	48	47	46	45	to	37	36	35	34	33	SW0067	64	63	62	61	to	53	52	51	50	49	b	b	b	b	b	b	b	b
	b15	b14	b13	b12	to	b4	b3	b2	b1	b0																																																							
SW0064	16	15	14	13	to	5	4	3	2	1																																																							
SW0065	32	31	30	29	to	21	20	19	18	17																																																							
SW0066	48	47	46	45	to	37	36	35	34	33																																																							
SW0067	64	63	62	61	to	53	52	51	50	49																																																							
*2 SW0068 (104)	Communication mode	The constant link scan setting status is stored. 0: No storage 1 to 500: Setting time [ms] Valid when SB0049 is off.	b	b	b	b	b	b	b	b	b																																																						

*2: Valid only when SB0047 is off (normal). When it turns on (error), the previous data is maintained.

Table 6.2 Link special register list (continued)

Number	Name	Details	Device usage availability							
			Inter-PC network				Remote I/O network			
			Mp		Ns		Mr		R	
			Optical fiber	Coax	Optical fiber	Coax	Optical fiber	Coax	Optical fiber	Coax
*2 SW006 B (107)	Max. link scan time	The max./min./current values for the link scan time are stored. (Unit [ms]) The time for the control station (remote master station) and normal station (remote I/O station) differ. <p>The constant scan setting is as follows:</p> <p>Control station (Setting value) < Link scan measured value + KB of the link scan time calculation expression → Link scan measured value + KB of the link scan time calculation expression (Setting value) < Link scan measured value + link scan time calculation method KB → Link scan measured value Normal station → Set constant link scan</p>	b	b	b	b	b	b	b	b
*2 SW006 C (108)	Min. link scan time		b	b	b	b	b	b	b	b
*2 SW006 D (109)	Current link scan time		b	b	b	b	b	b	b	b

*2: Valid only when SB0047 is off (normal). When it turns on (error), the previous data is maintained.

Table 6.2 Link special register list (continued)

Number	Name	Details	Device usage availability																																																														
			Inter-PC network				Remote I/O network																																																										
			Mp		Ns		Mr		R																																																								
			Optical fiber	Coax	Optical fiber	Coax	Optical fiber	Coax	Optical fiber	Coax																																																							
*2 SW0070 (112) • SW0071 (113) • SW0072 (114) • SW0073 (115)	Baton pass status at each station	<p>The baton pass status of each station is stored (including the host).</p> <p>(Online) 0: Normal (including stations beyond the max. station number and reserved stations) 1: Error</p> <p>(Offline test) 0: Normal 1: Error (including stations beyond the max. station number and reserved stations)</p> <table border="1"> <tr> <td></td> <td>b15</td> <td>b14</td> <td>b13</td> <td>b12</td> <td>to</td> <td>b4</td> <td>b3</td> <td>b2</td> <td>b1</td> <td>b0</td> </tr> <tr> <td>SW0070</td> <td>16</td> <td>15</td> <td>14</td> <td>13</td> <td>to</td> <td>5</td> <td>4</td> <td>3</td> <td>2</td> <td>1</td> </tr> <tr> <td>SW0071</td> <td>32</td> <td>31</td> <td>30</td> <td>29</td> <td>to</td> <td>21</td> <td>20</td> <td>19</td> <td>18</td> <td>17</td> </tr> <tr> <td>SW0072</td> <td>48</td> <td>47</td> <td>46</td> <td>45</td> <td>to</td> <td>37</td> <td>36</td> <td>35</td> <td>34</td> <td>33</td> </tr> <tr> <td>SW0073</td> <td>64</td> <td>63</td> <td>62</td> <td>61</td> <td>to</td> <td>53</td> <td>52</td> <td>51</td> <td>50</td> <td>49</td> </tr> </table> <p>1 to 64 in the table indicates the station number.</p>		b15	b14	b13	b12	to	b4	b3	b2	b1	b0	SW0070	16	15	14	13	to	5	4	3	2	1	SW0071	32	31	30	29	to	21	20	19	18	17	SW0072	48	47	46	45	to	37	36	35	34	33	SW0073	64	63	62	61	to	53	52	51	50	49	b	b	b	b	b	b	b	b
	b15	b14	b13	b12	to	b4	b3	b2	b1	b0																																																							
SW0070	16	15	14	13	to	5	4	3	2	1																																																							
SW0071	32	31	30	29	to	21	20	19	18	17																																																							
SW0072	48	47	46	45	to	37	36	35	34	33																																																							
SW0073	64	63	62	61	to	53	52	51	50	49																																																							

*2: Valid only when SB0047 is off (normal). When it turns on (error), the previous data is maintained.

Table 6.2 Link special register list (continued)

Number	Name	Details	Device usage availability																																																														
			Inter-PC network				Remote I/O network																																																										
			Mp		Ns		Mr		R																																																								
			Optical fiber	Coax	Optical fiber	Coax	Optical fiber	Coax	Optical fiber	Coax																																																							
*2 SW0074 (116) • SW0075 (117) • SW0076 (118) • SW0077 (119)	Cyclic transmission status of each station	<p>The cyclic transmission status of each station is stored (including host).</p> <p>0: Cyclic transmission in progress (including the stations beyond max. station number and reserved stations)</p> <p>1: Cyclic transmission not executed</p> <table border="1"> <tr> <td></td> <td>b15</td> <td>b14</td> <td>b13</td> <td>b12</td> <td>to</td> <td>b4</td> <td>b3</td> <td>b2</td> <td>b1</td> <td>b0</td> </tr> <tr> <td>SW0074</td> <td>16</td> <td>15</td> <td>14</td> <td>13</td> <td>to</td> <td>5</td> <td>4</td> <td>3</td> <td>2</td> <td>1</td> </tr> <tr> <td>SW0075</td> <td>32</td> <td>31</td> <td>30</td> <td>29</td> <td>to</td> <td>21</td> <td>20</td> <td>19</td> <td>18</td> <td>17</td> </tr> <tr> <td>SW0076</td> <td>48</td> <td>47</td> <td>46</td> <td>45</td> <td>to</td> <td>37</td> <td>36</td> <td>35</td> <td>34</td> <td>33</td> </tr> <tr> <td>SW0077</td> <td>64</td> <td>63</td> <td>62</td> <td>61</td> <td>to</td> <td>53</td> <td>52</td> <td>51</td> <td>50</td> <td>49</td> </tr> </table> <p>1 to 64 in the table indicates the station number.</p>		b15	b14	b13	b12	to	b4	b3	b2	b1	b0	SW0074	16	15	14	13	to	5	4	3	2	1	SW0075	32	31	30	29	to	21	20	19	18	17	SW0076	48	47	46	45	to	37	36	35	34	33	SW0077	64	63	62	61	to	53	52	51	50	49	b	b	b	b	b	b	b	b
	b15	b14	b13	b12	to	b4	b3	b2	b1	b0																																																							
SW0074	16	15	14	13	to	5	4	3	2	1																																																							
SW0075	32	31	30	29	to	21	20	19	18	17																																																							
SW0076	48	47	46	45	to	37	36	35	34	33																																																							
SW0077	64	63	62	61	to	53	52	51	50	49																																																							
*2 SW0078 (120) • SW0079 (121) • SW007A (122) • SW007B (123)	Parameter communication status at each station	<p>The parameter communication status of each station is stored.</p> <p>0: Parameter communication not in progress (including the stations beyond max. station number and reserved stations)</p> <p>1: Parameter communication in progress</p> <table border="1"> <tr> <td></td> <td>b15</td> <td>b14</td> <td>b13</td> <td>b12</td> <td>to</td> <td>b4</td> <td>b3</td> <td>b2</td> <td>b1</td> <td>b0</td> </tr> <tr> <td>SW0078</td> <td>16</td> <td>15</td> <td>14</td> <td>13</td> <td>to</td> <td>5</td> <td>4</td> <td>3</td> <td>2</td> <td>1</td> </tr> <tr> <td>SW0079</td> <td>32</td> <td>31</td> <td>30</td> <td>29</td> <td>to</td> <td>21</td> <td>20</td> <td>19</td> <td>18</td> <td>17</td> </tr> <tr> <td>SW007A</td> <td>48</td> <td>47</td> <td>46</td> <td>45</td> <td>to</td> <td>37</td> <td>36</td> <td>35</td> <td>34</td> <td>33</td> </tr> <tr> <td>SW007B</td> <td>64</td> <td>63</td> <td>62</td> <td>61</td> <td>to</td> <td>53</td> <td>52</td> <td>51</td> <td>50</td> <td>49</td> </tr> </table> <p>1 to 64 in the table indicates the station number.</p>		b15	b14	b13	b12	to	b4	b3	b2	b1	b0	SW0078	16	15	14	13	to	5	4	3	2	1	SW0079	32	31	30	29	to	21	20	19	18	17	SW007A	48	47	46	45	to	37	36	35	34	33	SW007B	64	63	62	61	to	53	52	51	50	49	b	b	×	×	b	b	×	×
	b15	b14	b13	b12	to	b4	b3	b2	b1	b0																																																							
SW0078	16	15	14	13	to	5	4	3	2	1																																																							
SW0079	32	31	30	29	to	21	20	19	18	17																																																							
SW007A	48	47	46	45	to	37	36	35	34	33																																																							
SW007B	64	63	62	61	to	53	52	51	50	49																																																							

*2: Valid only when SB0047 is off (normal). When it turns on (error), the previous data is maintained.

Table 6.2 Link special register list (continued)

Number	Name	Details	Device usage availability																																																														
			Inter-PC network				Remote I/O network																																																										
			Mp		Ns		Mr		R																																																								
			Optical fiber	Coax	Optical fiber	Coax	Optical fiber	Coax	Optical fiber	Coax																																																							
*2 SW007C (124) • SW007D (125) • SW007E (126) • SW007F (127)	Parameter error status at each station	The parameter status of each station is stored. 0: Parameter normal (including the stations beyond max. station number and reserved stations) 1: Parameter error <table border="1"> <tr> <td></td><td>b15</td><td>b14</td><td>b13</td><td>b12</td><td>to</td><td>b4</td><td>b3</td><td>b2</td><td>b1</td><td>b0</td> </tr> <tr> <td>SW007C</td><td>16</td><td>15</td><td>14</td><td>13</td><td>to</td><td>5</td><td>4</td><td>3</td><td>2</td><td>1</td> </tr> <tr> <td>SW007D</td><td>32</td><td>31</td><td>30</td><td>29</td><td>to</td><td>21</td><td>20</td><td>19</td><td>18</td><td>17</td> </tr> <tr> <td>SW007E</td><td>48</td><td>47</td><td>46</td><td>45</td><td>to</td><td>37</td><td>36</td><td>35</td><td>34</td><td>33</td> </tr> <tr> <td>SW007F</td><td>64</td><td>63</td><td>62</td><td>61</td><td>to</td><td>53</td><td>52</td><td>51</td><td>50</td><td>49</td> </tr> </table> 1 to 64 in the table indicates the station number.		b15	b14	b13	b12	to	b4	b3	b2	b1	b0	SW007C	16	15	14	13	to	5	4	3	2	1	SW007D	32	31	30	29	to	21	20	19	18	17	SW007E	48	47	46	45	to	37	36	35	34	33	SW007F	64	63	62	61	to	53	52	51	50	49	b	b	×	×	b	b	×	×
	b15	b14	b13	b12	to	b4	b3	b2	b1	b0																																																							
SW007C	16	15	14	13	to	5	4	3	2	1																																																							
SW007D	32	31	30	29	to	21	20	19	18	17																																																							
SW007E	48	47	46	45	to	37	36	35	34	33																																																							
SW007F	64	63	62	61	to	53	52	51	50	49																																																							
*2 SW0080 (128) • SW0081 (129) • SW0082 (130) • SW0083 (131)	CPU operation status (1) at each station	The CPU status of each station is stored (including host). Valid only when SW70 to 73 are normal. 0: Normal (including the stations beyond max. station number and reserved stations) 1: Mid/serious error <table border="1"> <tr> <td></td><td>b15</td><td>b14</td><td>b13</td><td>b12</td><td>to</td><td>b4</td><td>b3</td><td>b2</td><td>b1</td><td>b0</td> </tr> <tr> <td>SW0080</td><td>16</td><td>15</td><td>14</td><td>13</td><td>to</td><td>5</td><td>4</td><td>3</td><td>2</td><td>1</td> </tr> <tr> <td>SW0081</td><td>32</td><td>31</td><td>30</td><td>29</td><td>to</td><td>21</td><td>20</td><td>19</td><td>18</td><td>17</td> </tr> <tr> <td>SW0082</td><td>48</td><td>47</td><td>46</td><td>45</td><td>to</td><td>37</td><td>36</td><td>35</td><td>34</td><td>33</td> </tr> <tr> <td>SW0083</td><td>64</td><td>63</td><td>62</td><td>61</td><td>to</td><td>53</td><td>52</td><td>51</td><td>50</td><td>49</td> </tr> </table> 1 to 64 in the table indicates the station number.		b15	b14	b13	b12	to	b4	b3	b2	b1	b0	SW0080	16	15	14	13	to	5	4	3	2	1	SW0081	32	31	30	29	to	21	20	19	18	17	SW0082	48	47	46	45	to	37	36	35	34	33	SW0083	64	63	62	61	to	53	52	51	50	49	b	b	b	b	b	b	b	b
	b15	b14	b13	b12	to	b4	b3	b2	b1	b0																																																							
SW0080	16	15	14	13	to	5	4	3	2	1																																																							
SW0081	32	31	30	29	to	21	20	19	18	17																																																							
SW0082	48	47	46	45	to	37	36	35	34	33																																																							
SW0083	64	63	62	61	to	53	52	51	50	49																																																							

*2: Valid only when SB0047 is off (normal). When it turns on (error), the previous data is maintained.

Table 6.2 Link special register list (continued)

Number	Name	Details	Device usage availability																																																														
			Inter-PC network				Remote I/O network																																																										
			Mp		Ns		Mr		R																																																								
			Optical fiber	Coax	Optical fiber	Coax	Optical fiber	Coax	Optical fiber	Coax																																																							
*2 SW0084 (132) • SW0085 (133) • SW0086 (134) • SW0087 (135)	CPU RUN status at each reach station	<p>The CPU RUN status for each station is stored (including host). The standby-system Q4ARCPU stores the key switch status at normal state. Valid only for stations with SW70 to 73 being normal.</p> <p>0: RUN or STEP RUN (including stations beyond max. station number and reserved stations) 1: STOP, PAUSE, ERROR</p> <table border="1"> <tr> <td></td><td>b15</td><td>b14</td><td>b13</td><td>b12</td><td>to</td><td>b4</td><td>b3</td><td>b2</td><td>b1</td><td>b0</td> </tr> <tr> <td>SW0084</td><td>16</td><td>15</td><td>14</td><td>13</td><td>to</td><td>5</td><td>4</td><td>3</td><td>2</td><td>1</td> </tr> <tr> <td>SW0085</td><td>32</td><td>31</td><td>30</td><td>29</td><td>to</td><td>21</td><td>20</td><td>19</td><td>18</td><td>17</td> </tr> <tr> <td>SW0086</td><td>48</td><td>47</td><td>46</td><td>45</td><td>to</td><td>37</td><td>36</td><td>35</td><td>34</td><td>33</td> </tr> <tr> <td>SW0087</td><td>64</td><td>63</td><td>62</td><td>61</td><td>to</td><td>53</td><td>52</td><td>51</td><td>50</td><td>49</td> </tr> </table> <p>1 to 64 in the table indicates the station number.</p>		b15	b14	b13	b12	to	b4	b3	b2	b1	b0	SW0084	16	15	14	13	to	5	4	3	2	1	SW0085	32	31	30	29	to	21	20	19	18	17	SW0086	48	47	46	45	to	37	36	35	34	33	SW0087	64	63	62	61	to	53	52	51	50	49	b	b	b	b	×	×	×	×
	b15	b14	b13	b12	to	b4	b3	b2	b1	b0																																																							
SW0084	16	15	14	13	to	5	4	3	2	1																																																							
SW0085	32	31	30	29	to	21	20	19	18	17																																																							
SW0086	48	47	46	45	to	37	36	35	34	33																																																							
SW0087	64	63	62	61	to	53	52	51	50	49																																																							
*2 SW0088 (136) • SW0089 (137) • SW008A (138) • SW008B (139)	CPU operation status at each station (2)	<p>The CPU status of each station is stored (including host). Valid for stations with SW70 to 73 being normal.</p> <p>0: Normal (including stations beyond max. station number and reserved stations) 1: Minor error</p> <table border="1"> <tr> <td></td><td>b15</td><td>b14</td><td>b13</td><td>b12</td><td>to</td><td>b4</td><td>b3</td><td>b2</td><td>b1</td><td>b0</td> </tr> <tr> <td>SW0088</td><td>16</td><td>15</td><td>14</td><td>13</td><td>to</td><td>5</td><td>4</td><td>3</td><td>2</td><td>1</td> </tr> <tr> <td>SW0089</td><td>32</td><td>31</td><td>30</td><td>29</td><td>to</td><td>21</td><td>20</td><td>19</td><td>18</td><td>17</td> </tr> <tr> <td>SW008A</td><td>48</td><td>47</td><td>46</td><td>45</td><td>to</td><td>37</td><td>36</td><td>35</td><td>34</td><td>33</td> </tr> <tr> <td>SW008B</td><td>64</td><td>63</td><td>62</td><td>61</td><td>to</td><td>53</td><td>52</td><td>51</td><td>50</td><td>49</td> </tr> </table> <p>1 to 64 in the table indicates the station number.</p>		b15	b14	b13	b12	to	b4	b3	b2	b1	b0	SW0088	16	15	14	13	to	5	4	3	2	1	SW0089	32	31	30	29	to	21	20	19	18	17	SW008A	48	47	46	45	to	37	36	35	34	33	SW008B	64	63	62	61	to	53	52	51	50	49	b	b	b	b	b	b	b	b
	b15	b14	b13	b12	to	b4	b3	b2	b1	b0																																																							
SW0088	16	15	14	13	to	5	4	3	2	1																																																							
SW0089	32	31	30	29	to	21	20	19	18	17																																																							
SW008A	48	47	46	45	to	37	36	35	34	33																																																							
SW008B	64	63	62	61	to	53	52	51	50	49																																																							

*2: Valid only when SB0047 is off (normal). When it turns on (error), the previous data is maintained.

Table 6.2 Link special register list (continued)

Number	Name	Details	Device usage availability																																																														
			Inter-PC network				Remote I/O network																																																										
			Mp		Ns		Mr		R																																																								
			Optical fiber	Coax	Optical fiber	Coax	Optical fiber	Coax	Optical fiber	Coax																																																							
*2 SW008C (140) • SW008D (141) • SW008E (142) • SW008F (143)	External power supply existence information for other stations	<p>The external power supply status of each station is stored (including host). Valid only for stations with SW70 to 73 being normal.</p> <p>0: No power supply (including stations beyond max. station number and reserved stations) 1: Power supply exists</p> <table border="1"> <tr> <td></td> <td>b15</td> <td>b14</td> <td>b13</td> <td>b12</td> <td>to</td> <td>b4</td> <td>b3</td> <td>b2</td> <td>b1</td> <td>b0</td> </tr> <tr> <td>SW008C</td> <td>16</td> <td>15</td> <td>14</td> <td>13</td> <td>to</td> <td>5</td> <td>4</td> <td>3</td> <td>2</td> <td>1</td> </tr> <tr> <td>SW008D</td> <td>32</td> <td>31</td> <td>30</td> <td>29</td> <td>to</td> <td>21</td> <td>20</td> <td>19</td> <td>18</td> <td>17</td> </tr> <tr> <td>SW008E</td> <td>48</td> <td>47</td> <td>46</td> <td>45</td> <td>to</td> <td>37</td> <td>36</td> <td>35</td> <td>34</td> <td>33</td> </tr> <tr> <td>SW008F</td> <td>64</td> <td>63</td> <td>62</td> <td>61</td> <td>to</td> <td>53</td> <td>52</td> <td>51</td> <td>50</td> <td>49</td> </tr> </table> <p>1 to 64 in the table indicates the station number.</p>		b15	b14	b13	b12	to	b4	b3	b2	b1	b0	SW008C	16	15	14	13	to	5	4	3	2	1	SW008D	32	31	30	29	to	21	20	19	18	17	SW008E	48	47	46	45	to	37	36	35	34	33	SW008F	64	63	62	61	to	53	52	51	50	49	b	×	b	×	b	×	b	×
	b15	b14	b13	b12	to	b4	b3	b2	b1	b0																																																							
SW008C	16	15	14	13	to	5	4	3	2	1																																																							
SW008D	32	31	30	29	to	21	20	19	18	17																																																							
SW008E	48	47	46	45	to	37	36	35	34	33																																																							
SW008F	64	63	62	61	to	53	52	51	50	49																																																							
*2 SW0090 (144)	Loop-back information	<p>The loop status of the host is stored.</p> <p>0: Loop normal 1: Forward loop error 2: Reverser loop error 3: Loop back 4: Data link not possible</p>	b	×	b	×	b	×	b	×																																																							

*2: Valid only when SB0047 is off (normal). When it turns on (error), the previous data is maintained.

Table 6.2 Link special register list (continued)

Number	Name	Details	Device usage availability																																																														
			Inter-PC network				Remote I/O network																																																										
			Mp		Ns		Mr		R																																																								
			Optical fiber	Coax	Optical fiber	Coax	Optical fiber	Coax	Optical fiber	Coax																																																							
*2 SW0091 (145) • SW0092 (146) • SW0093 (147) • SW0094 (148)	Forward loop status at each station	<p>The forward loop status at each station is stored (including host). 0: Normal (including stations beyond max. station number and reserved stations) 1: Error</p> <p>The disconnected station is maintained at the status before disconnection.</p> <table border="1"> <thead> <tr> <th></th> <th>b15</th> <th>b14</th> <th>b13</th> <th>b12</th> <th>to</th> <th>b4</th> <th>b3</th> <th>b2</th> <th>b1</th> <th>b0</th> </tr> </thead> <tbody> <tr> <td>SW0091</td> <td>16</td> <td>15</td> <td>14</td> <td>13</td> <td>to</td> <td>5</td> <td>4</td> <td>3</td> <td>2</td> <td>1</td> </tr> <tr> <td>SW0092</td> <td>32</td> <td>31</td> <td>30</td> <td>29</td> <td>to</td> <td>21</td> <td>20</td> <td>19</td> <td>18</td> <td>17</td> </tr> <tr> <td>SW0093</td> <td>48</td> <td>47</td> <td>46</td> <td>45</td> <td>to</td> <td>37</td> <td>36</td> <td>35</td> <td>34</td> <td>33</td> </tr> <tr> <td>SW0094</td> <td>64</td> <td>63</td> <td>62</td> <td>61</td> <td>to</td> <td>53</td> <td>52</td> <td>51</td> <td>50</td> <td>49</td> </tr> </tbody> </table> <p>1 to 64 in the table indicates the station number.</p>		b15	b14	b13	b12	to	b4	b3	b2	b1	b0	SW0091	16	15	14	13	to	5	4	3	2	1	SW0092	32	31	30	29	to	21	20	19	18	17	SW0093	48	47	46	45	to	37	36	35	34	33	SW0094	64	63	62	61	to	53	52	51	50	49	b	×	b	×	b	×	b	×
	b15	b14	b13	b12	to	b4	b3	b2	b1	b0																																																							
SW0091	16	15	14	13	to	5	4	3	2	1																																																							
SW0092	32	31	30	29	to	21	20	19	18	17																																																							
SW0093	48	47	46	45	to	37	36	35	34	33																																																							
SW0094	64	63	62	61	to	53	52	51	50	49																																																							
*2 SW0095 (149) • SW0096 (150) • SW0097 (151) • SW0098 (152)	Reverse loop status at each station	<p>The reverse loop status at each station is stored (including host). 0: Normal (including stations beyond max. station number and reserved stations) 1: Error</p> <table border="1"> <thead> <tr> <th></th> <th>b15</th> <th>b14</th> <th>b13</th> <th>b12</th> <th>to</th> <th>b4</th> <th>b3</th> <th>b2</th> <th>b1</th> <th>b0</th> </tr> </thead> <tbody> <tr> <td>SW0095</td> <td>16</td> <td>15</td> <td>14</td> <td>13</td> <td>to</td> <td>5</td> <td>4</td> <td>3</td> <td>2</td> <td>1</td> </tr> <tr> <td>SW0096</td> <td>32</td> <td>31</td> <td>30</td> <td>29</td> <td>to</td> <td>21</td> <td>20</td> <td>19</td> <td>18</td> <td>17</td> </tr> <tr> <td>SW0097</td> <td>48</td> <td>47</td> <td>46</td> <td>45</td> <td>to</td> <td>37</td> <td>36</td> <td>35</td> <td>34</td> <td>33</td> </tr> <tr> <td>SW0098</td> <td>64</td> <td>63</td> <td>62</td> <td>61</td> <td>to</td> <td>53</td> <td>52</td> <td>51</td> <td>50</td> <td>49</td> </tr> </tbody> </table> <p>1 to 64 in the table indicates the station number.</p>		b15	b14	b13	b12	to	b4	b3	b2	b1	b0	SW0095	16	15	14	13	to	5	4	3	2	1	SW0096	32	31	30	29	to	21	20	19	18	17	SW0097	48	47	46	45	to	37	36	35	34	33	SW0098	64	63	62	61	to	53	52	51	50	49	b	×	b	×	b	×	b	×
	b15	b14	b13	b12	to	b4	b3	b2	b1	b0																																																							
SW0095	16	15	14	13	to	5	4	3	2	1																																																							
SW0096	32	31	30	29	to	21	20	19	18	17																																																							
SW0097	48	47	46	45	to	37	36	35	34	33																																																							
SW0098	64	63	62	61	to	53	52	51	50	49																																																							

*2: Valid only when SB0047 is off (normal). When it turns on (error), the previous data is maintained.

Table 6.2 Link special register list (continued)

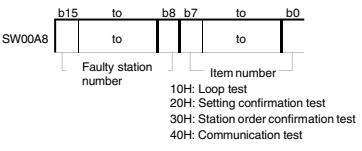
Number	Name	Details	Device usage availability							
			Inter-PC network				Remote I/O network			
			Mp		Ns		Mr		R	
			Optical fiber	Coax	Optical fiber	Coax	Optical fiber	Coax	Optical fiber	Coax
*2 SW0099 (153)	Loop-back station (forward loop)	The station number executing a loopback on the forward loop side is stored. Range: 1 to 64	b	×	b	×	b	×	b	×
*2 SW009A (154)	Loop-back station (reverse loop)	The station number executing a loopback on the reverse loop side is stored. Range: 1 to 64	b	×	b	×	b	×	b	×
*2 SW00A8 (168)	Online test item/faulty station (request side)	The online test items and error stations on the requesting side is stored. Valid when SB00A9 is on. 	b	b	b	b	b	b	b	b
*2 SW00A9 (169)	Online test result (request side)	The online result on the requesting side is stored. (Valid when SB00A9 is on.) 0: Test normal 1 to: Test error details (Refer to Chapter 9)	b	b	b	b	b	b	b	b

*2: Valid only when SB0047 is off (normal). When it turns on (error), the previous data is maintained.

Table 6.2 Link special register list (continued)

Number	Name	Details	Device usage availability							
			Inter-PC network				Remote I/O network			
			Mp		Ns		Mr		R	
			Optical fiber	Coax	Optical fiber	Coax	Optical fiber	Coax	Optical fiber	Coax
*2 SW00AA (170)	Online test item (response side)	<p>The online test item on the response side is stored. (Valid when SB00AB is on.)</p> <p>10H: Loop test 20H: Setting confirmation test 30H: Station order confirmation test 40H: Communication test</p>	b	b	b	b	b	b	b	b
*2 SW00AB (171)	Online test result (response side)	<p>The online test result on the response side is stored. (Valid when SB00AB is on.)</p> <p>0: Test normal 1 to: Test error details (Refer to Chapter 9)</p>	b	b	b	b	b	b	b	b
*2 SW00AC (172)	Offline test item/faulty station (request side)	<p>The offline test item and faulty station on the request side are stored. (Valid when SB00AD is on.)</p> <p>3: Loop test (forward loop) 4: Loop test (reverse loop) 5: Station-to-station test (master station) 6: Station-to-station test (slave station) 7: Self-loopback test 8: Internal self-loopback test</p>	b	b	b	b	b	b	b	b

*2: Valid only when SB0047 is off (normal). When it turns on (error), the previous data is maintained.

Table 6.2 Link special register list (continued)

Number	Name	Details	Device usage availability																			
			Inter-PC network				Remote I/O network															
			Mp		Ns		Mr		R													
			Optical fiber	Coax	Optical fiber	Coax	Optical fiber	Coax	Optical fiber	Coax												
*2 SW00AD (173)	Offline test result (request side)	The offline test result on the request side is stored. (Valid when SB00AD is on.) 0: Test normal 1 to: Test error details	b	b	b	b	b	b	b	b												
*2 SW00AE (174)	Offline test item (response side)	The offline test item on the response side is stored. (Valid when SB00AF is on.) <div style="display: flex; align-items: center;"> <div style="margin-right: 5px;">SW00AE</div> <table border="1" style="border-collapse: collapse; text-align: center;"> <tr> <td style="width: 15px;">b15</td> <td style="width: 15px;">to</td> <td style="width: 15px;">b8</td> <td style="width: 15px;">b7</td> <td style="width: 15px;">to</td> <td style="width: 15px;">b0</td> </tr> <tr> <td>0</td> <td>to</td> <td>0</td> <td></td> <td>to</td> <td></td> </tr> </table> <div style="margin-left: 10px; font-size: small;"> Item number 3: Loop test (forward loop) 4: Loop test (reverse loop) </div> </div>	b15	to	b8	b7	to	b0	0	to	0		to		b	b	b	b	b	b	b	b
b15	to	b8	b7	to	b0																	
0	to	0		to																		
*2 SW00AF (175)	Online test result (response side)	The offline test result on the response side is stored. (Valid when SB00AF is on.) 0: Test normal 1 to: Test error details	b	b	b	b	b	b	b	b												

*2: Valid only when SB0047 is off (normal). When it turns on (error), the previous data is maintained.

Table 6.2 Link special register list (continued)

Number	Name	Details	Device usage availability																																																														
			Inter-PC network				Remote I/O network																																																										
			Mp		Ns		Mr		R																																																								
			Optical fiber	Coax	Optical fiber	Coax	Optical fiber	Coax	Optical fiber	Coax																																																							
*2 SW00B0 (176) • SW00B1 (177) • SW00B2 (178) • SW00B3 (179)	Multiplex transmission status (1)	<p>The forward loop usage status at each station during multiplex transmission is stored.</p> <p>0: Other than forward loop 1: Forward loop in use</p> <table border="1"> <tr> <td></td> <td>b15</td> <td>b14</td> <td>b13</td> <td>b12</td> <td>to</td> <td>b4</td> <td>b3</td> <td>b2</td> <td>b1</td> <td>b0</td> </tr> <tr> <td>SW00B0</td> <td>16</td> <td>15</td> <td>14</td> <td>13</td> <td>to</td> <td>5</td> <td>4</td> <td>3</td> <td>2</td> <td>1</td> </tr> <tr> <td>SW00B1</td> <td>32</td> <td>31</td> <td>30</td> <td>29</td> <td>to</td> <td>21</td> <td>20</td> <td>19</td> <td>18</td> <td>17</td> </tr> <tr> <td>SW00B2</td> <td>48</td> <td>47</td> <td>46</td> <td>45</td> <td>to</td> <td>37</td> <td>36</td> <td>35</td> <td>34</td> <td>33</td> </tr> <tr> <td>SW00B3</td> <td>64</td> <td>63</td> <td>62</td> <td>61</td> <td>to</td> <td>53</td> <td>52</td> <td>51</td> <td>50</td> <td>49</td> </tr> </table> <p>1 to 64 in the table indicates the station number.</p>		b15	b14	b13	b12	to	b4	b3	b2	b1	b0	SW00B0	16	15	14	13	to	5	4	3	2	1	SW00B1	32	31	30	29	to	21	20	19	18	17	SW00B2	48	47	46	45	to	37	36	35	34	33	SW00B3	64	63	62	61	to	53	52	51	50	49	b	×	b	×	b	×	b	×
	b15	b14	b13	b12	to	b4	b3	b2	b1	b0																																																							
SW00B0	16	15	14	13	to	5	4	3	2	1																																																							
SW00B1	32	31	30	29	to	21	20	19	18	17																																																							
SW00B2	48	47	46	45	to	37	36	35	34	33																																																							
SW00B3	64	63	62	61	to	53	52	51	50	49																																																							
*2 SW00B4 (180) • SW00B5 (181) • SW00B6 (182) • SW00B7 (183)	Multiplex transmission status (2)	<p>The reverse loop usage status at each station during multiplex transmission is stored.</p> <p>0: Other than reverse loop 1: Reverse loop in use</p> <table border="1"> <tr> <td></td> <td>b15</td> <td>b14</td> <td>b13</td> <td>b12</td> <td>to</td> <td>b4</td> <td>b3</td> <td>b2</td> <td>b1</td> <td>b0</td> </tr> <tr> <td>SW00B4</td> <td>16</td> <td>15</td> <td>14</td> <td>13</td> <td>to</td> <td>5</td> <td>4</td> <td>3</td> <td>2</td> <td>1</td> </tr> <tr> <td>SW00B5</td> <td>32</td> <td>31</td> <td>30</td> <td>29</td> <td>to</td> <td>21</td> <td>20</td> <td>19</td> <td>18</td> <td>17</td> </tr> <tr> <td>SW00B6</td> <td>48</td> <td>47</td> <td>46</td> <td>45</td> <td>to</td> <td>37</td> <td>36</td> <td>35</td> <td>34</td> <td>33</td> </tr> <tr> <td>SW00B7</td> <td>64</td> <td>63</td> <td>62</td> <td>61</td> <td>to</td> <td>53</td> <td>52</td> <td>51</td> <td>50</td> <td>49</td> </tr> </table> <p>1 to 64 in the table indicates the station number.</p>		b15	b14	b13	b12	to	b4	b3	b2	b1	b0	SW00B4	16	15	14	13	to	5	4	3	2	1	SW00B5	32	31	30	29	to	21	20	19	18	17	SW00B6	48	47	46	45	to	37	36	35	34	33	SW00B7	64	63	62	61	to	53	52	51	50	49	b	×	b	×	b	×	b	×
	b15	b14	b13	b12	to	b4	b3	b2	b1	b0																																																							
SW00B4	16	15	14	13	to	5	4	3	2	1																																																							
SW00B5	32	31	30	29	to	21	20	19	18	17																																																							
SW00B6	48	47	46	45	to	37	36	35	34	33																																																							
SW00B7	64	63	62	61	to	53	52	51	50	49																																																							

*2: Valid only when SB0047 is off (normal). When it turns on (error), the previous data is maintained.

Table 6.2 Link special register list (continued)

Number	Name	Details	Device usage availability								
			Inter-PC network				Remote I/O network				
			Mp		Ns		Mr		R		
			Optical fiber	Coax	Optical fiber	Coax	Optical fiber	Coax	Optical fiber	Coax	
*2*3 SW00B8 (184)	Forward loop side UNDER	The number of "UNDER" errors on the forward loop is counted and stored. 0 to: Number of errors	b	b	b	b	b	b	b	b	b
*2*3 SW00B9 (185)	Forward loop side CRC	The number of "CRC" errors on the forward loop is counted and stored. 0 to: Number of errors	b	b	b	b	b	b	b	b	b
*2*3 SW00BA (186)	Forward loop side OVER	The number of "OVER" errors on the forward loop is counted and stored. 0 to: Number of errors	b	b	b	b	b	b	b	b	b
*2*3 SW00BB (187)	Forward loop side short frame	The number of "short frame" errors on the forward loop is counted and stored. 0 to: Number of errors	b	b	b	b	b	b	b	b	b
*2*3 SW00BC (188)	Forward loop side abort (AB.IF)	The number of "AB.IF" errors on the forward loop is counted and stored. 0 to: Number of errors	b	b	b	b	b	b	b	b	b
*2*3 SW00BD (189)	Forward loop side timeout (TIME)	The number of "TIME" errors on the forward loop is counted and stored. 0 to: Number of errors	b	b	b	b	b	b	b	b	b
*2*3 SW00BE (190)	Forward loop side more than 2k bytes received (DATA)	The number of "DATA" errors on the forward loop is counted and stored. 0 to: Number of errors	b	b	b	b	b	b	b	b	b

*2: Valid only when SB0047 is off (normal). When it turns on (error), the previous data is maintained.

*3: Turn SB0006 on to reset SW00B8 to C7.

For the number of SW00B8 to C7, it will not have problems when count is incremented little by little over a long period of time.

When the count is incremented in a short amount of time (when monitoring by peripheral device, etc.) , there may be problems with the cable.

Table 6.2 Link special register list (continued)

Number	Name	Details	Device usage availability								
			Inter-PC network				Remote I/O network				
			Mp		Ns		Mr		R		
			Optical fiber	Coax	Optical fiber	Coax	Optical fiber	Coax	Optical fiber	Coax	
*2*3 SW00BF (191)	Forward loop side DPLL error	The number of "DPLL" errors on the forward loop is counted and stored. 0 to: Number of errors	b	b	b	b	b	b	b	b	b
*2*3 SW00C0 (192)	Reverse loop side UNDER	The number of "UNDER" errors on the reverse loop is counted and stored. 0 to: Number of errors	b	b	b	b	b	b	b	b	b
*2*3 SW00C1 (193)	Reverse loop side CRC	The number of "CRC" errors on the reverse loop is counted and stored. 0 to: Number of errors	b	b	b	b	b	b	b	b	b
*2*3 SW00C2 (194)	Reverse loop side OVER	The number of "OVER" errors on the reverse loop is counted and stored. 0 to: Number of errors	b	b	b	b	b	b	b	b	b
*2*3 SW00C3 (195)	Reverse loop side short frame	The number of "short frame" errors on the reverse loop is counted and stored. 0 to: Number of errors	b	b	b	b	b	b	b	b	b
*2*3 SW00C4 (196)	Reverse loop side abort (AB.IF)	The number of "AB.IF" errors on the reverse loop is counted and stored. 0 to: Number of errors	b	b	b	b	b	b	b	b	b
*2*3 SW00C5 (197)	Reverse loop side timeout (TIME)	The number of "TIME" errors on the reverse loop is counted and stored. 0 to: Number of errors	b	b	b	b	b	b	b	b	b

*2: Valid only when SB0047 is off (normal). When it turns on (error), the previous data is maintained.

*3: Turn on SB0006 to reset SW00B8 to C7.

For the number of SW00B8 to C7, it will not have problems when count is incremented little by little over a long period of time.

When the count is incremented in a short amount of time (when monitoring by peripheral device, etc.) , there may be problems with the cable.

Table 6.2 Link special register list (continued)

Number	Name	Details	Device usage availability							
			Inter-PC network				Remote I/O network			
			Mp		Ns		Mr		R	
			Optical fiber	Coax	Optical fiber	Coax	Optical fiber	Coax	Optical fiber	Coax
*2*3 SW00C6 (198)	Reverse loop side more than 2k bytes received (DATA)	The number of "DATA" errors on the reverse loop is counted and stored. 0 to: Number of errors	b	b	b	b	b	b	b	b
*2*3 SW00C7 (199)	Reverse loop side DPLL error	The number of "DPLL" errors on the reverse loop is counted and stored. 0 to: Number of errors	b	b	b	b	b	b	b	b
*2*4 SW00C8 (200)	Forward loop side number of retries	The number of retries on the forward loop is counted and stored. 0 to: Number of errors	b	b	b	b	b	b	b	b
*2*4 SW00C9 (201)	Reverse loop side number of retries	The number of retries on the reverse loop is counted and stored. 0 to: Number of errors	b	b	b	b	b	b	b	b
*2*5 SW00CC (204)	Forward loop side line error	The number of line error detections on the forward loop is counted and stored. 0 to: Number of line errors detected	b	×	b	×	b	×	b	×
*2*6 SW00CD (205)	Reverse loop side line error	The number of line error detections on the reverse loop is counted and stored. 0 to: Number of line errors detected	b	×	b	×	b	×	b	×
*2*7 SW00CE (206)	Number of loop switches	The number of loop checks performed is counted and stored. 0 to: Number of loop switches	b	×	b	×	b	×	b	×

*2: Valid only when SB0047 is off (normal). When it turns on (error), the previous data is maintained.

*3: Turn on SB0006 to reset SW00B8 to C7.

For the number of SW00B8 to C7, it will not have problems when count is incremented little by little over a long period of time.

When the count is incremented in a short amount of time (when monitoring by peripheral device, etc.) , there may be problems with the cable.

*4: The count may be incremented when the power is turned on/reset, however, they are not errors.

When the number of retries is not necessary before data link is started, clear with SB0005.

*5: Turn on SB0007 to reset SW00CC.

*6: Turn on SB0008 to reset SW00CD.

*7: Turn on SB0009 to reset SW00CD to E7.

Table 6.2 Link special register list (continued)

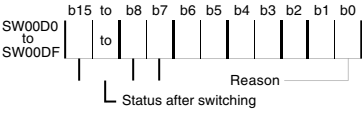
Number	Name	Details	Device usage availability							
			Inter-PC network				Remote I/O network			
			Mp		Ns		Mr		R	
			Optical fiber	Coax	Optical fiber	Coax	Optical fiber	Coax	Optical fiber	Coax
*2*7 SW00CF (207)	Loop switch data pointer	The pointer that sets the next loop switch data is stored.	b	×	b	×	b	×	b	×
*2*7 SW00D0 (208) to SW00DF (223)	Loop switch data	<p>The reason and status of loop switch is stored. The data overwrite/maintain is set by the common parameters.</p>  <p>(Reason) The bit corresponding to each error is set to 1. All 0: Recovery specification b0: Forward loop H/W error b1: Reverse loop H/W error b2: Forward loop forced error b3: Reverse loop forced error b4: Forward loop continuous communication error b5: Reverse loop continuous communication error b6: Forward loop continuous line error b7: Reverse loop continuous line error</p> <p>(Status after switching) 0: Multiplex transmission (forward loop/reverse loop normal) 1: Data link with forward loop 2: Data link with reverse loop 3: Data link with loop back</p>	b	×	b	×	b	×	b	×

*2: Valid only when SB0047 is off (normal). When it turns on (error), the previous data is maintained.

*7: Turn on SB0009 to reset SW00CD to E7.

Table 6.2 Link special register list (continued)

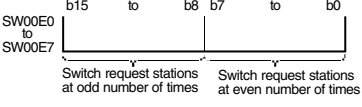
Number	Name	Details	Device usage availability							
			Inter-PC network				Remote I/O network			
			Mp		Ns		Mr		R	
			Optical fiber	Coax	Optical fiber	Coax	Optical fiber	Coax	Optical fiber	Coax
*2*7*8 SW00E0 (224) to SW00E7 (231)	Switch request station	The station number requesting the loop switch is stored. 	b	×	b	×	b	×	b	×
*9 SW00EE (238)	Transient transmission error	The number of transient-transmission error is counted and stored. 0 to: Number of errors	b	b	b	b	b	b	b	b
*9 SW00EF (239)	Transient transmission error pointer	The pointer to set the next transient-transmission error data is stored.	b	b	b	b	b	b	b	b
*2 SW00F0 (240) to SW00FF (255)	Transient transmission error data	The transient-transmission error data is stored.	b	b	b	b	b	b	b	b

*2: Valid only when SB0047 is off (normal). When it turns on (error), the previous data is maintained.

*7: Turn on SB0009 to reset SW00CD to E7.

*8: The loop switch request is performed by the station detecting the loop error first, so the station besides the two adjacent stations at the loop error may be stored.

*9: Turn on SB0C0A to reset SW00EE to EF.

Table 6.2 Link special register list (continued)

Number	Name	Details	Device usage availability																																																														
			Inter-PC network				Remote I/O network																																																										
			Mp		Ns		Mr		R																																																								
			Optical fiber	Coax	Optical fiber	Coax	Optical fiber	Coax	Optical fiber	Coax																																																							
*2 SW01F0 (496) • SW01F1 (497) • SW01F2 (498) • SW01F3 (499)	User-flag status	The user-flag status is stored. 0: Flag off 1: Flag on <table border="1" style="font-size: small;"> <tr> <td></td> <td>b15</td> <td>b14</td> <td>b13</td> <td>b12</td> <td>to</td> <td>b4</td> <td>b3</td> <td>b2</td> <td>b1</td> <td>b0</td> </tr> <tr> <td>SW01F0</td> <td>16</td> <td>15</td> <td>14</td> <td>13</td> <td>to</td> <td>5</td> <td>4</td> <td>3</td> <td>2</td> <td>1</td> </tr> <tr> <td>SW01F1</td> <td>32</td> <td>31</td> <td>30</td> <td>29</td> <td>to</td> <td>21</td> <td>20</td> <td>19</td> <td>18</td> <td>17</td> </tr> <tr> <td>SW01F2</td> <td>48</td> <td>47</td> <td>46</td> <td>45</td> <td>to</td> <td>37</td> <td>36</td> <td>35</td> <td>34</td> <td>33</td> </tr> <tr> <td>SW01F3</td> <td>64</td> <td>63</td> <td>62</td> <td>61</td> <td>to</td> <td>53</td> <td>52</td> <td>51</td> <td>50</td> <td>49</td> </tr> </table> 1 to 64 in the table indicates the station number.		b15	b14	b13	b12	to	b4	b3	b2	b1	b0	SW01F0	16	15	14	13	to	5	4	3	2	1	SW01F1	32	31	30	29	to	21	20	19	18	17	SW01F2	48	47	46	45	to	37	36	35	34	33	SW01F3	64	63	62	61	to	53	52	51	50	49								
	b15	b14	b13	b12	to	b4	b3	b2	b1	b0																																																							
SW01F0	16	15	14	13	to	5	4	3	2	1																																																							
SW01F1	32	31	30	29	to	21	20	19	18	17																																																							
SW01F2	48	47	46	45	to	37	36	35	34	33																																																							
SW01F3	64	63	62	61	to	53	52	51	50	49																																																							

*2: Valid only when SB0047 is off (normal). When it turns on (error), the previous data is maintained.

6.3 SB/SW Valid during offline test

Most SB/SW are invalid during the offline test except for the SB/SW shown below. However, these are valid for only control station and master station.

Valid SB/SW		Mode setting switch				
		3	4	5 to 8	A	B
SB	00AC	b	b	b	b	b
	00AD	b	b	b	b	b
SW	0047	×	×	b	b	b
	0048	×	×	b	b	b
	0049	×	×	b	b	b
	0070 to 73	b	b	×	×	×
	00AC	b	b	b	b	b
	00AD	b	b	b	b	b

b: Valid ×: Invalid

7. Remote I/O Station Special Relay (M, SM)/Special Register (D, SD)

The special relays (M9000 to, SM0 to) and special registers (D9000 to, SD0 to) of the remote I/O station are described.

The special relays/registers can be set its monitoring, on/off, and data from the peripheral device.

7.1 Special relay (M, SM)

Table 7.1 Special relay (M)

Number	Name	Details
*1 M9000	Fuse shut off	OFF: Normal ON: There is an output module with a fuse shut off. (Remains on as long as it is not reset even if the output module is back to normal.)
*1 M9002	I/O module verification error	OFF: Normal ON: I/O verification error (Different from the status when the I/O module power is turned on. → Module has been removed.) (Remains on as long as it is not reset even if the module is back to normal.)
*1 M9008	Self diagnosis error	OFF: Normal ON: Error detection (Error code is stored in D9008.) (Remains on as long as it is not reset even if the module is back to normal.)
M9084	Error check	OFF: Perform error check (Fuse shut off, I/O module verification error) ON: No error checking
M9094	I/O replacement flag	OFF: No replacement ON: Replace (The replacement can be replaced by turning on M9094 after setting the first I/O number the I/O module to replace to D9094.)

*1: The RMT.E LED turns on.

Table 7.2 Special relay (SM)

Number	Name	Details
*1 SM1	Self diagnosis error	OFF: Normal ON: Error detection (Remains on as long as it is not reset even if the output module is back to normal.)
*1 SM60	Fuse shut off	OFF: Normal ON: There is an output module with fuse shut off. (Remains on as long as it is not reset even if the output module is back to normal.)
*1 SM61	I/O module verification error	OFF: Normal ON: I/O verification error (Different from the status when the I/O module power is turned on. → Module has been removed.) (Remains on as long as it is not reset even if the output module is back to normal.)
SM251	I/O replacement flag	OFF: Not replaced ON: Replaced (The replacement can be performed by turning on SM251 after setting the first I/O number of the I/O module to be replaced with SD251)
SM252	I/O replacement OK	OFF: Replacement not possible ON: Replacement possible
SM253	Peripheral device connection flag	OFF: Not connected ON: Connected
SM1000 to SM1255	Special relay corresponding to ACPU	The special relays corresponding to M9000 to 9255 are stored.

*1: The RMT.E LED turns on.

7.2 Special register (D, SD)

Table 7.3 Special register (D)

Number	Name	Details
D9000	Fuse shut off module number (valid when M9000 is on)	The first I/O number of the module with fuse shut off is stored. When the errors occur in multiple output module, the smallest first I/O number is stored. (EX.: Y50 to 6F output module → Hex "50H" is stored.)
D9002	I/O module verification error module number (valid when M9002 is on)	The first I/O number of the module with I/O module verification error is stored. When the errors occur in multiple output modules, the smallest first I/O number is stored. (EX.: Y50 to 6F output module → Hex "50H" is stored.)
D9008	Self-diagnosis error number (valid when M9008 is on)	Self-diagnosis error detail is stored.
D9010	Error slot number	The slot number where the module causing the self-diagnosis error is stored.
D9014	I/O control method	I/O control method is stored. 3: Input and output refreshed.
D9015	Operation status	Remote I/O station CPU operation status is stored. 1: STOP
D9072	PC communication check	Area to perform communication check with remote I/O station CPU in the independent self-loopback test of calculator link module.
D9091	Self-diagnosis error detail number	Self-diagnosis error details are stored.
D9094	Replacement I/O first I/O number	The first I/O number of the module removed or installed during online is stored. (EX.: Y50 to 6F output module → Hex "50H" is stored.)

Table 7.3 Special register (D) (continued)

Number	Name	Details																																																																																																																																																									
D9100 to D9107	Fuse shut off error module	<p>"1" is stored in the I/O number (16-point module) for the output module with fuse shut off status. 0 to 7F0 in the table indicate the I/O numbers.</p> <table border="1" data-bbox="566 338 1406 600"> <thead> <tr> <th></th> <th>b15</th> <th>b14</th> <th>b13</th> <th>b12</th> <th>b11</th> <th>b10</th> <th>b9</th> <th>b8</th> <th>b7</th> <th>b6</th> <th>b5</th> <th>b4</th> <th>b3</th> <th>b2</th> <th>b1</th> <th>b0</th> </tr> </thead> <tbody> <tr> <td>D9100</td> <td>F0</td> <td>E0</td> <td>D0</td> <td>C0</td> <td>B0</td> <td>A0</td> <td>90</td> <td>80</td> <td>70</td> <td>60</td> <td>50</td> <td>40</td> <td>30</td> <td>20</td> <td>10</td> <td>0</td> </tr> <tr> <td>D9101</td> <td>1F0</td> <td>1E0</td> <td>1D0</td> <td>1C0</td> <td>1B0</td> <td>1A0</td> <td>190</td> <td>180</td> <td>170</td> <td>160</td> <td>150</td> <td>140</td> <td>130</td> <td>120</td> <td>110</td> <td>100</td> </tr> <tr> <td>D9102</td> <td>2F0</td> <td>2E0</td> <td>2D0</td> <td>2C0</td> <td>2B0</td> <td>2A0</td> <td>290</td> <td>280</td> <td>270</td> <td>260</td> <td>250</td> <td>240</td> <td>230</td> <td>220</td> <td>210</td> <td>200</td> </tr> <tr> <td>D9103</td> <td>3F0</td> <td>3E0</td> <td>3D0</td> <td>3C0</td> <td>3B0</td> <td>3A0</td> <td>390</td> <td>380</td> <td>370</td> <td>360</td> <td>350</td> <td>340</td> <td>330</td> <td>320</td> <td>310</td> <td>300</td> </tr> <tr> <td>D9104</td> <td>4F0</td> <td>4E0</td> <td>4D0</td> <td>4C0</td> <td>4B0</td> <td>4A0</td> <td>490</td> <td>480</td> <td>470</td> <td>460</td> <td>450</td> <td>440</td> <td>430</td> <td>420</td> <td>410</td> <td>400</td> </tr> <tr> <td>D9105</td> <td>5F0</td> <td>5E0</td> <td>5D0</td> <td>5C0</td> <td>5B0</td> <td>5A0</td> <td>590</td> <td>580</td> <td>570</td> <td>560</td> <td>550</td> <td>540</td> <td>530</td> <td>520</td> <td>510</td> <td>500</td> </tr> <tr> <td>D9106</td> <td>6F0</td> <td>6E0</td> <td>6D0</td> <td>6C0</td> <td>6B0</td> <td>6A0</td> <td>690</td> <td>680</td> <td>670</td> <td>660</td> <td>650</td> <td>640</td> <td>630</td> <td>620</td> <td>610</td> <td>600</td> </tr> <tr> <td>D9107</td> <td>7F0</td> <td>7E0</td> <td>7D0</td> <td>7C0</td> <td>7B0</td> <td>7A0</td> <td>790</td> <td>780</td> <td>770</td> <td>760</td> <td>750</td> <td>740</td> <td>730</td> <td>720</td> <td>710</td> <td>700</td> </tr> </tbody> </table>		b15	b14	b13	b12	b11	b10	b9	b8	b7	b6	b5	b4	b3	b2	b1	b0	D9100	F0	E0	D0	C0	B0	A0	90	80	70	60	50	40	30	20	10	0	D9101	1F0	1E0	1D0	1C0	1B0	1A0	190	180	170	160	150	140	130	120	110	100	D9102	2F0	2E0	2D0	2C0	2B0	2A0	290	280	270	260	250	240	230	220	210	200	D9103	3F0	3E0	3D0	3C0	3B0	3A0	390	380	370	360	350	340	330	320	310	300	D9104	4F0	4E0	4D0	4C0	4B0	4A0	490	480	470	460	450	440	430	420	410	400	D9105	5F0	5E0	5D0	5C0	5B0	5A0	590	580	570	560	550	540	530	520	510	500	D9106	6F0	6E0	6D0	6C0	6B0	6A0	690	680	670	660	650	640	630	620	610	600	D9107	7F0	7E0	7D0	7C0	7B0	7A0	790	780	770	760	750	740	730	720	710	700
	b15	b14	b13	b12	b11	b10	b9	b8	b7	b6	b5	b4	b3	b2	b1	b0																																																																																																																																											
D9100	F0	E0	D0	C0	B0	A0	90	80	70	60	50	40	30	20	10	0																																																																																																																																											
D9101	1F0	1E0	1D0	1C0	1B0	1A0	190	180	170	160	150	140	130	120	110	100																																																																																																																																											
D9102	2F0	2E0	2D0	2C0	2B0	2A0	290	280	270	260	250	240	230	220	210	200																																																																																																																																											
D9103	3F0	3E0	3D0	3C0	3B0	3A0	390	380	370	360	350	340	330	320	310	300																																																																																																																																											
D9104	4F0	4E0	4D0	4C0	4B0	4A0	490	480	470	460	450	440	430	420	410	400																																																																																																																																											
D9105	5F0	5E0	5D0	5C0	5B0	5A0	590	580	570	560	550	540	530	520	510	500																																																																																																																																											
D9106	6F0	6E0	6D0	6C0	6B0	6A0	690	680	670	660	650	640	630	620	610	600																																																																																																																																											
D9107	7F0	7E0	7D0	7C0	7B0	7A0	790	780	770	760	750	740	730	720	710	700																																																																																																																																											
D9116 to D9123	I/O module verification error module	<p>"1" is stored in the I/O number (16-point module) for the output module with I/O module verification error. 0 to 7F0 in the table indicate the I/O numbers.</p> <table border="1" data-bbox="566 786 1406 1048"> <thead> <tr> <th></th> <th>b15</th> <th>b14</th> <th>b13</th> <th>b12</th> <th>b11</th> <th>b10</th> <th>b9</th> <th>b8</th> <th>b7</th> <th>b6</th> <th>b5</th> <th>b4</th> <th>b3</th> <th>b2</th> <th>b1</th> <th>b0</th> </tr> </thead> <tbody> <tr> <td>D9116</td> <td>F0</td> <td>E0</td> <td>D0</td> <td>C0</td> <td>B0</td> <td>A0</td> <td>90</td> <td>80</td> <td>70</td> <td>60</td> <td>50</td> <td>40</td> <td>30</td> <td>20</td> <td>10</td> <td>0</td> </tr> <tr> <td>D9117</td> <td>1F0</td> <td>1E0</td> <td>1D0</td> <td>1C0</td> <td>1B0</td> <td>1A0</td> <td>190</td> <td>180</td> <td>170</td> <td>160</td> <td>150</td> <td>140</td> <td>130</td> <td>120</td> <td>110</td> <td>100</td> </tr> <tr> <td>D9118</td> <td>2F0</td> <td>2E0</td> <td>2D0</td> <td>2C0</td> <td>2B0</td> <td>2A0</td> <td>290</td> <td>280</td> <td>270</td> <td>260</td> <td>250</td> <td>240</td> <td>230</td> <td>220</td> <td>210</td> <td>200</td> </tr> <tr> <td>D9119</td> <td>3F0</td> <td>3E0</td> <td>3D0</td> <td>3C0</td> <td>3B0</td> <td>3A0</td> <td>390</td> <td>380</td> <td>370</td> <td>360</td> <td>350</td> <td>340</td> <td>330</td> <td>320</td> <td>310</td> <td>300</td> </tr> <tr> <td>D9120</td> <td>4F0</td> <td>4E0</td> <td>4D0</td> <td>4C0</td> <td>4B0</td> <td>4A0</td> <td>490</td> <td>480</td> <td>470</td> <td>460</td> <td>450</td> <td>440</td> <td>430</td> <td>420</td> <td>410</td> <td>400</td> </tr> <tr> <td>D9121</td> <td>5F0</td> <td>5E0</td> <td>5D0</td> <td>5C0</td> <td>5B0</td> <td>5A0</td> <td>590</td> <td>580</td> <td>570</td> <td>560</td> <td>550</td> <td>540</td> <td>530</td> <td>520</td> <td>510</td> <td>500</td> </tr> <tr> <td>D9122</td> <td>6F0</td> <td>6E0</td> <td>6D0</td> <td>6C0</td> <td>6B0</td> <td>6A0</td> <td>690</td> <td>680</td> <td>670</td> <td>660</td> <td>650</td> <td>640</td> <td>630</td> <td>620</td> <td>610</td> <td>600</td> </tr> <tr> <td>D9123</td> <td>7F0</td> <td>7E0</td> <td>7D0</td> <td>7C0</td> <td>7B0</td> <td>7A0</td> <td>790</td> <td>780</td> <td>770</td> <td>760</td> <td>750</td> <td>740</td> <td>730</td> <td>720</td> <td>710</td> <td>700</td> </tr> </tbody> </table>		b15	b14	b13	b12	b11	b10	b9	b8	b7	b6	b5	b4	b3	b2	b1	b0	D9116	F0	E0	D0	C0	B0	A0	90	80	70	60	50	40	30	20	10	0	D9117	1F0	1E0	1D0	1C0	1B0	1A0	190	180	170	160	150	140	130	120	110	100	D9118	2F0	2E0	2D0	2C0	2B0	2A0	290	280	270	260	250	240	230	220	210	200	D9119	3F0	3E0	3D0	3C0	3B0	3A0	390	380	370	360	350	340	330	320	310	300	D9120	4F0	4E0	4D0	4C0	4B0	4A0	490	480	470	460	450	440	430	420	410	400	D9121	5F0	5E0	5D0	5C0	5B0	5A0	590	580	570	560	550	540	530	520	510	500	D9122	6F0	6E0	6D0	6C0	6B0	6A0	690	680	670	660	650	640	630	620	610	600	D9123	7F0	7E0	7D0	7C0	7B0	7A0	790	780	770	760	750	740	730	720	710	700
	b15	b14	b13	b12	b11	b10	b9	b8	b7	b6	b5	b4	b3	b2	b1	b0																																																																																																																																											
D9116	F0	E0	D0	C0	B0	A0	90	80	70	60	50	40	30	20	10	0																																																																																																																																											
D9117	1F0	1E0	1D0	1C0	1B0	1A0	190	180	170	160	150	140	130	120	110	100																																																																																																																																											
D9118	2F0	2E0	2D0	2C0	2B0	2A0	290	280	270	260	250	240	230	220	210	200																																																																																																																																											
D9119	3F0	3E0	3D0	3C0	3B0	3A0	390	380	370	360	350	340	330	320	310	300																																																																																																																																											
D9120	4F0	4E0	4D0	4C0	4B0	4A0	490	480	470	460	450	440	430	420	410	400																																																																																																																																											
D9121	5F0	5E0	5D0	5C0	5B0	5A0	590	580	570	560	550	540	530	520	510	500																																																																																																																																											
D9122	6F0	6E0	6D0	6C0	6B0	6A0	690	680	670	660	650	640	630	620	610	600																																																																																																																																											
D9123	7F0	7E0	7D0	7C0	7B0	7A0	790	780	770	760	750	740	730	720	710	700																																																																																																																																											

Table 7.4 Special registers (SD)

Number	Name	Details																																																																																																																																																									
SD0	Diagnosis error number	The details of the diagnosis error (SM0 is on) is stored. (Refer to Table 7.5.)																																																																																																																																																									
SD60	Fuse shutoff module number	The first I/O number of the output module with fuse shutoff. However, if the errors occur in multiple output modules, the smallest first I/O number is stored. (e.g.: Y50 to 6F output module → Hex "50H" is stored.)																																																																																																																																																									
SD61	I/O module verification error module number	The first I/O number of the module with the I/O module verification error is stored. However, if the errors occur in multiple output modules, the smallest first I/O number is stored. (e.g.: Y50 to 6F output module → Hex "50H" is stored.)																																																																																																																																																									
SD203	CPU operation status	Remote I/O station CPU operation status is stored. 0: RUN																																																																																																																																																									
SD251	Replacement I/O first I/O number	The first I/O number of the I/O module removed or installed during online is stored. (e.g.: Y50 to 6F output module → Hex "50H" is stored.)																																																																																																																																																									
SD1000 to SD1255	Special register corresponding to ACPU	The special registers corresponding to D9000 to 9255 are stored.																																																																																																																																																									
SD1300 to SD1307	Fuse shutoff error module	<p>The I/O number (16-point unit) of the output module with fuse shutoff is set to "1". 0 to 7F0 in the table indicate the I/O numbers.</p> <table border="1"> <thead> <tr> <th></th> <th>b15</th><th>b14</th><th>b13</th><th>b12</th><th>b11</th><th>b10</th><th>b9</th><th>b8</th><th>b7</th><th>b6</th><th>b5</th><th>b4</th><th>b3</th><th>b2</th><th>b1</th><th>b0</th> </tr> </thead> <tbody> <tr> <td>SD1300</td> <td>F0</td><td>E0</td><td>D0</td><td>C0</td><td>B0</td><td>A0</td><td>90</td><td>80</td><td>70</td><td>60</td><td>50</td><td>40</td><td>30</td><td>20</td><td>10</td><td>0</td> </tr> <tr> <td>SD1301</td> <td>1F0</td><td>1E0</td><td>1D0</td><td>1C0</td><td>1B0</td><td>1A0</td><td>190</td><td>180</td><td>170</td><td>160</td><td>150</td><td>140</td><td>130</td><td>120</td><td>110</td><td>100</td> </tr> <tr> <td>SD1302</td> <td>2F0</td><td>2E0</td><td>2D0</td><td>2C0</td><td>2B0</td><td>2A0</td><td>290</td><td>280</td><td>270</td><td>260</td><td>250</td><td>240</td><td>230</td><td>220</td><td>210</td><td>200</td> </tr> <tr> <td>SD1303</td> <td>3F0</td><td>3E0</td><td>3D0</td><td>3C0</td><td>3B0</td><td>3A0</td><td>390</td><td>380</td><td>370</td><td>360</td><td>350</td><td>340</td><td>330</td><td>320</td><td>310</td><td>300</td> </tr> <tr> <td>SD1304</td> <td>4F0</td><td>4E0</td><td>4D0</td><td>4C0</td><td>4B0</td><td>4A0</td><td>490</td><td>480</td><td>470</td><td>460</td><td>450</td><td>440</td><td>430</td><td>420</td><td>410</td><td>400</td> </tr> <tr> <td>SD1305</td> <td>5F0</td><td>5E0</td><td>5D0</td><td>5C0</td><td>5B0</td><td>5A0</td><td>590</td><td>580</td><td>570</td><td>560</td><td>550</td><td>540</td><td>530</td><td>520</td><td>510</td><td>500</td> </tr> <tr> <td>SD1306</td> <td>6F0</td><td>6E0</td><td>6D0</td><td>6C0</td><td>6B0</td><td>6A0</td><td>690</td><td>680</td><td>670</td><td>660</td><td>650</td><td>640</td><td>630</td><td>620</td><td>610</td><td>600</td> </tr> <tr> <td>SD1307</td> <td>7F0</td><td>7E0</td><td>7D0</td><td>7C0</td><td>7B0</td><td>7A0</td><td>790</td><td>780</td><td>770</td><td>760</td><td>750</td><td>740</td><td>730</td><td>720</td><td>710</td><td>700</td> </tr> </tbody> </table>		b15	b14	b13	b12	b11	b10	b9	b8	b7	b6	b5	b4	b3	b2	b1	b0	SD1300	F0	E0	D0	C0	B0	A0	90	80	70	60	50	40	30	20	10	0	SD1301	1F0	1E0	1D0	1C0	1B0	1A0	190	180	170	160	150	140	130	120	110	100	SD1302	2F0	2E0	2D0	2C0	2B0	2A0	290	280	270	260	250	240	230	220	210	200	SD1303	3F0	3E0	3D0	3C0	3B0	3A0	390	380	370	360	350	340	330	320	310	300	SD1304	4F0	4E0	4D0	4C0	4B0	4A0	490	480	470	460	450	440	430	420	410	400	SD1305	5F0	5E0	5D0	5C0	5B0	5A0	590	580	570	560	550	540	530	520	510	500	SD1306	6F0	6E0	6D0	6C0	6B0	6A0	690	680	670	660	650	640	630	620	610	600	SD1307	7F0	7E0	7D0	7C0	7B0	7A0	790	780	770	760	750	740	730	720	710	700
	b15	b14	b13	b12	b11	b10	b9	b8	b7	b6	b5	b4	b3	b2	b1	b0																																																																																																																																											
SD1300	F0	E0	D0	C0	B0	A0	90	80	70	60	50	40	30	20	10	0																																																																																																																																											
SD1301	1F0	1E0	1D0	1C0	1B0	1A0	190	180	170	160	150	140	130	120	110	100																																																																																																																																											
SD1302	2F0	2E0	2D0	2C0	2B0	2A0	290	280	270	260	250	240	230	220	210	200																																																																																																																																											
SD1303	3F0	3E0	3D0	3C0	3B0	3A0	390	380	370	360	350	340	330	320	310	300																																																																																																																																											
SD1304	4F0	4E0	4D0	4C0	4B0	4A0	490	480	470	460	450	440	430	420	410	400																																																																																																																																											
SD1305	5F0	5E0	5D0	5C0	5B0	5A0	590	580	570	560	550	540	530	520	510	500																																																																																																																																											
SD1306	6F0	6E0	6D0	6C0	6B0	6A0	690	680	670	660	650	640	630	620	610	600																																																																																																																																											
SD1307	7F0	7E0	7D0	7C0	7B0	7A0	790	780	770	760	750	740	730	720	710	700																																																																																																																																											
SD1400 to SD1407	I/O module verification error module	<p>The I/O number (16-point unit) of the output module with I/O module verification error is set to "1". 0 to 7F0 in the table indicate the I/O numbers.</p> <table border="1"> <thead> <tr> <th></th> <th>b15</th><th>b14</th><th>b13</th><th>b12</th><th>b11</th><th>b10</th><th>b9</th><th>b8</th><th>b7</th><th>b6</th><th>b5</th><th>b4</th><th>b3</th><th>b2</th><th>b1</th><th>b0</th> </tr> </thead> <tbody> <tr> <td>SD1400</td> <td>F0</td><td>E0</td><td>D0</td><td>C0</td><td>B0</td><td>A0</td><td>90</td><td>80</td><td>70</td><td>60</td><td>50</td><td>40</td><td>30</td><td>20</td><td>10</td><td>0</td> </tr> <tr> <td>SD1401</td> <td>1F0</td><td>1E0</td><td>1D0</td><td>1C0</td><td>1B0</td><td>1A0</td><td>190</td><td>180</td><td>170</td><td>160</td><td>150</td><td>140</td><td>130</td><td>120</td><td>110</td><td>100</td> </tr> <tr> <td>SD1402</td> <td>2F0</td><td>2E0</td><td>2D0</td><td>2C0</td><td>2B0</td><td>2A0</td><td>290</td><td>280</td><td>270</td><td>260</td><td>250</td><td>240</td><td>230</td><td>220</td><td>210</td><td>200</td> </tr> <tr> <td>SD1403</td> <td>3F0</td><td>3E0</td><td>3D0</td><td>3C0</td><td>3B0</td><td>3A0</td><td>390</td><td>380</td><td>370</td><td>360</td><td>350</td><td>340</td><td>330</td><td>320</td><td>310</td><td>300</td> </tr> <tr> <td>SD1404</td> <td>4F0</td><td>4E0</td><td>4D0</td><td>4C0</td><td>4B0</td><td>4A0</td><td>490</td><td>480</td><td>470</td><td>460</td><td>450</td><td>440</td><td>430</td><td>420</td><td>410</td><td>400</td> </tr> <tr> <td>SD1405</td> <td>5F0</td><td>5E0</td><td>5D0</td><td>5C0</td><td>5B0</td><td>5A0</td><td>590</td><td>580</td><td>570</td><td>560</td><td>550</td><td>540</td><td>530</td><td>520</td><td>510</td><td>500</td> </tr> <tr> <td>SD1406</td> <td>6F0</td><td>6E0</td><td>6D0</td><td>6C0</td><td>6B0</td><td>6A0</td><td>690</td><td>680</td><td>670</td><td>660</td><td>650</td><td>640</td><td>630</td><td>620</td><td>610</td><td>600</td> </tr> <tr> <td>SD1407</td> <td>7F0</td><td>7E0</td><td>7D0</td><td>7C0</td><td>7B0</td><td>7A0</td><td>790</td><td>780</td><td>770</td><td>760</td><td>750</td><td>740</td><td>730</td><td>720</td><td>710</td><td>700</td> </tr> </tbody> </table>		b15	b14	b13	b12	b11	b10	b9	b8	b7	b6	b5	b4	b3	b2	b1	b0	SD1400	F0	E0	D0	C0	B0	A0	90	80	70	60	50	40	30	20	10	0	SD1401	1F0	1E0	1D0	1C0	1B0	1A0	190	180	170	160	150	140	130	120	110	100	SD1402	2F0	2E0	2D0	2C0	2B0	2A0	290	280	270	260	250	240	230	220	210	200	SD1403	3F0	3E0	3D0	3C0	3B0	3A0	390	380	370	360	350	340	330	320	310	300	SD1404	4F0	4E0	4D0	4C0	4B0	4A0	490	480	470	460	450	440	430	420	410	400	SD1405	5F0	5E0	5D0	5C0	5B0	5A0	590	580	570	560	550	540	530	520	510	500	SD1406	6F0	6E0	6D0	6C0	6B0	6A0	690	680	670	660	650	640	630	620	610	600	SD1407	7F0	7E0	7D0	7C0	7B0	7A0	790	780	770	760	750	740	730	720	710	700
	b15	b14	b13	b12	b11	b10	b9	b8	b7	b6	b5	b4	b3	b2	b1	b0																																																																																																																																											
SD1400	F0	E0	D0	C0	B0	A0	90	80	70	60	50	40	30	20	10	0																																																																																																																																											
SD1401	1F0	1E0	1D0	1C0	1B0	1A0	190	180	170	160	150	140	130	120	110	100																																																																																																																																											
SD1402	2F0	2E0	2D0	2C0	2B0	2A0	290	280	270	260	250	240	230	220	210	200																																																																																																																																											
SD1403	3F0	3E0	3D0	3C0	3B0	3A0	390	380	370	360	350	340	330	320	310	300																																																																																																																																											
SD1404	4F0	4E0	4D0	4C0	4B0	4A0	490	480	470	460	450	440	430	420	410	400																																																																																																																																											
SD1405	5F0	5E0	5D0	5C0	5B0	5A0	590	580	570	560	550	540	530	520	510	500																																																																																																																																											
SD1406	6F0	6E0	6D0	6C0	6B0	6A0	690	680	670	660	650	640	630	620	610	600																																																																																																																																											
SD1407	7F0	7E0	7D0	7C0	7B0	7A0	790	780	770	760	750	740	730	720	710	700																																																																																																																																											

Table 7.5 Error code

D9008 SD0 (Hex)	D9091 (Hex)	Name	Details	Operation status *1	
				Cyclic	I/O
11* ²	111	I/O allocation error	There is an error in the I/O allocation.	Stops	Conti- nues
	112 113	B/W points insufficient	The B/W points set in the common parameter are insufficient for the number of special function modules.		
31* ³	311	I/O module verification error	I/O module verification error occurred.	By master station	
32* ³	321	Fuse shutoff error	Fuse shutoff error occurred.		
43* ³	431	Incorrect interruption occurred	Interruption occurred from a module besides the intelligent special function module.	Conti- nues	Stops
44* ³	441	Number of installed intelligent special function module error	More than two intelligent special function modules are installed.		
	442	Special function module sumcheck error	Sumcheck value verification error for the AnUCPU special function module occurred.		

*1: Operation

Stops: Cannot accessed with I/O module or special function module

Continues: Forced output is possible from peripheral device with "test mode".

By master station: Stop/continue by QnA (R) CPU parameter

[Operation method] menu → Parameter → PC RAS setting → Operation mode when error occurs

*2: The PRM.E. LED turns on.

*3: The RMT.E. LED turns on.

8. Duplex Network Special Link Relay (SB)/ Register (SW)

Special link relays (SB) and registers (SW), use of which become valid only on duplex network, are described below.

Refer to simplex network's Section 10.7 SB0000 to 01F0 and SW0000 to 01F3.

8.1 Special link relay (SB)

A summary of special link relays (SB) is shown in Table 8.1.

Table 8.1 Special link relay (SB)

Number	Name	Contents	Device usage availability							
			Inter-PC network				Remote I/O network			
			Mp		Ns		Mr		R	
			Optical fiber	Coax	Optical fiber	Coax	Optical fiber	Coax	Optical fiber	Coax
SB01F4 (500)	Each station in CPU operation mode	Status of each station's CPU operation mode (SW01F4 to SW01F7) is shown. OFF: All stations in CPU backup mode ON: Separate mode station exists.	b	b	b	b	—	—	—	—
SB01F8 (504)	Each station in pairing status	Pairing setting status (SW01F8 to SW01FB) are shown. OFF: No pairing settings. ON: Pairing setting exists.	b	b	b	b	—	—	—	—
SB01FC (508)	Each station in CPU operation status (control system/standby system)	Status of CPU operation mode (SW01FC to SW01FF) for each station is shown. OFF: All stations in control system. ON: Station in standby system exists.	b	b	b	b	—	—	—	—

8.2 Special link register (SW)

Special link register (SW) is shown in Table 8.2

Table 8.2 Special link relay (SW)

Number	Name	Contents	Device usage availability																																																													
			Inter-PC network				Remote I/O network																																																									
			Mp		Ns		Mr		R																																																							
			Optical fiber	Coax	Optical fiber	Coax	Optical fiber	Coax	Optical fiber	Coax																																																						
SW01F4 (500) SW01F5 (501) SW01F6 (502) SW01F7 (503)	CPU operation mode of each station	Status of each station's CPU operation mode is shown. 0: Backup mode (including stand-alone system). 1: Separate mode <table border="1"> <tr><td>b15</td><td>b14</td><td>b13</td><td>b12</td><td>to</td><td>b4</td><td>b3</td><td>b2</td><td>b1</td><td>b0</td></tr> <tr><td>SW01F4</td><td>16</td><td>15</td><td>14</td><td>13</td><td>to</td><td>5</td><td>4</td><td>3</td><td>2</td><td>1</td></tr> <tr><td>SW01F5</td><td>32</td><td>31</td><td>30</td><td>29</td><td>to</td><td>21</td><td>20</td><td>19</td><td>18</td><td>17</td></tr> <tr><td>SW01F6</td><td>48</td><td>47</td><td>46</td><td>45</td><td>to</td><td>37</td><td>36</td><td>35</td><td>34</td><td>33</td></tr> <tr><td>SW01F7</td><td>64</td><td>63</td><td>62</td><td>61</td><td>to</td><td>53</td><td>52</td><td>51</td><td>50</td><td>49</td></tr> </table> <p>1 to 64 in the table indicate station numbers.</p>	b15	b14	b13	b12	to	b4	b3	b2	b1	b0	SW01F4	16	15	14	13	to	5	4	3	2	1	SW01F5	32	31	30	29	to	21	20	19	18	17	SW01F6	48	47	46	45	to	37	36	35	34	33	SW01F7	64	63	62	61	to	53	52	51	50	49	b	b	b	b	—	—	—	—
b15	b14	b13	b12	to	b4	b3	b2	b1	b0																																																							
SW01F4	16	15	14	13	to	5	4	3	2	1																																																						
SW01F5	32	31	30	29	to	21	20	19	18	17																																																						
SW01F6	48	47	46	45	to	37	36	35	34	33																																																						
SW01F7	64	63	62	61	to	53	52	51	50	49																																																						
SW01F8 (504) SW01F9 (505) SW01FA (506) SW01FB (507)	Pairing condition of each station	Pairing setting status is shown. 0: Station without pairing setting (including stand-alone system) 1: Station with pairing setting <table border="1"> <tr><td>b15</td><td>b14</td><td>b13</td><td>b12</td><td>to</td><td>b4</td><td>b3</td><td>b2</td><td>b1</td><td>b0</td></tr> <tr><td>SW01F8</td><td>16</td><td>15</td><td>14</td><td>13</td><td>to</td><td>5</td><td>4</td><td>3</td><td>2</td><td>1</td></tr> <tr><td>SW01F9</td><td>32</td><td>31</td><td>30</td><td>29</td><td>to</td><td>21</td><td>20</td><td>19</td><td>18</td><td>17</td></tr> <tr><td>SW01FA</td><td>48</td><td>47</td><td>46</td><td>45</td><td>to</td><td>37</td><td>36</td><td>35</td><td>34</td><td>33</td></tr> <tr><td>SW01FB</td><td>64</td><td>63</td><td>62</td><td>61</td><td>to</td><td>53</td><td>52</td><td>51</td><td>50</td><td>49</td></tr> </table> <p>1 to 64 in the table indicate station numbers.</p>	b15	b14	b13	b12	to	b4	b3	b2	b1	b0	SW01F8	16	15	14	13	to	5	4	3	2	1	SW01F9	32	31	30	29	to	21	20	19	18	17	SW01FA	48	47	46	45	to	37	36	35	34	33	SW01FB	64	63	62	61	to	53	52	51	50	49	b	b	b	b	—	—	—	—
b15	b14	b13	b12	to	b4	b3	b2	b1	b0																																																							
SW01F8	16	15	14	13	to	5	4	3	2	1																																																						
SW01F9	32	31	30	29	to	21	20	19	18	17																																																						
SW01FA	48	47	46	45	to	37	36	35	34	33																																																						
SW01FB	64	63	62	61	to	53	52	51	50	49																																																						
SW01FC (508) SW01FD (509) SW01FE (510) SW01FF (511)	CPU operation condition of each station	CPU operation condition of each station is shown. 0: Control system (including stand-alone system) 1: Standby system <table border="1"> <tr><td>b15</td><td>b14</td><td>b13</td><td>b12</td><td>to</td><td>b4</td><td>b3</td><td>b2</td><td>b1</td><td>b0</td></tr> <tr><td>SW01FC</td><td>16</td><td>15</td><td>14</td><td>13</td><td>to</td><td>5</td><td>4</td><td>3</td><td>2</td><td>1</td></tr> <tr><td>SW01FD</td><td>32</td><td>31</td><td>30</td><td>29</td><td>to</td><td>21</td><td>20</td><td>19</td><td>18</td><td>17</td></tr> <tr><td>SW01FE</td><td>48</td><td>47</td><td>46</td><td>45</td><td>to</td><td>37</td><td>36</td><td>35</td><td>34</td><td>33</td></tr> <tr><td>SW01FF</td><td>64</td><td>63</td><td>62</td><td>61</td><td>to</td><td>53</td><td>52</td><td>51</td><td>50</td><td>49</td></tr> </table> <p>1 to 64 in the table indicate station numbers.</p>	b15	b14	b13	b12	to	b4	b3	b2	b1	b0	SW01FC	16	15	14	13	to	5	4	3	2	1	SW01FD	32	31	30	29	to	21	20	19	18	17	SW01FE	48	47	46	45	to	37	36	35	34	33	SW01FF	64	63	62	61	to	53	52	51	50	49	b	b	b	b	—	—	—	—
b15	b14	b13	b12	to	b4	b3	b2	b1	b0																																																							
SW01FC	16	15	14	13	to	5	4	3	2	1																																																						
SW01FD	32	31	30	29	to	21	20	19	18	17																																																						
SW01FE	48	47	46	45	to	37	36	35	34	33																																																						
SW01FF	64	63	62	61	to	53	52	51	50	49																																																						

9. Error Codes

When transient transmission is performed from the instruction or peripheral device and cannot have proper communication, an error code (hexadecimal) is stored or displayed.

(1) The following shows the location where error code is stored.

For 4_{aaa} error codes, refer to Q2AS(H)CPU(-SI) User's Manual (Detailed Section).

(a) Instructions

- 1) SEND, RECV, READ, WRITE, REQ, ZNFR, ZNTO: Control data completion status (o+1)
- 2) ZNRD: SW31
- 3) ZNWR: SW33

(b) Peripheral Device

The error code is displayed above the function key display.

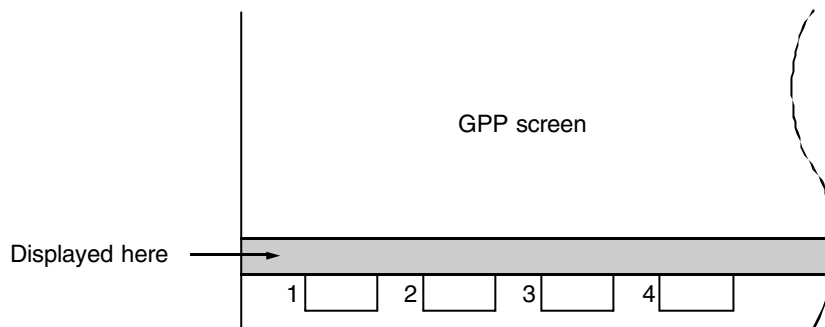

(2) The error code descriptions are shown in Table 9.1.

Table 9.1 Error code list

Error No.	Error description	Corrective action
F101	Initial status	Make SB0047 (baton-pass status)/SB0049 (data link status) to be off (normal).
F102	Initial status	
F103	Initial status (during on-line test)	
F104	Control station/subcontrol station transfer status	
F105	Initial status	
F106	Control station/subcontrol station transfer status	
F107	Baton-pass error (baton lost)	
F108	Baton-pass error (baton overlap)	
F109	Initial status (during on-line test)	
F10A	Initial status (during on-line test/off-line loop test)	
F10B	Station number overlap error	Correct station number.
F10C	Control station overlap error	Correct control station setting.
F10D	Off-line status	Make it on-line.
F10E	Receive error retry over	Check for cable damage, hardware error, noise, miswiring, missing terminal resistor connection (during bus), station number overlap or control station overlap.
F10F	Send error retry over	
F110	Time out error	
F111	Corresponding station error	Re-examine corresponding station's status, parameter, switch settings (confirm if there is no parameter errors and if the corresponding station is properly set at the control station).
F112	Loop condition failure	Check for cable damage, hardware error, noise, miswiring, station number overlap or control station overlap.
F113	Send error	Retry after waiting for a while. If the error repeats, check for cable damage, hardware error, noise, miswiring, missing terminal resistor connection (during bus), station number overlap or control station overlap. Re-examine parameter and switch settings. (Confirm if there is no parameter errors and if the corresponding station is properly set at the control station.)

Table 9.1 Error code list (continued)

Error No.	Error description	Corrective action
F114	Send error	Retry after waiting for a while. If the error repeats, check for cable damage, hardware error, noise, miswiring, missing terminal resistor connection (during bus), station number overlap or control station overlap.
F117	Send error	Check for cable damage, hardware error, noise, miswiring, station number overlap or control station overlap.
F118	Initial status (baton replay)	Wait until SB0047 (baton-pass status)/SB0049 (data link status) turn off (normal).
F11A	Send error (multiple loop transmission stopped)	Retry after waiting for a while.
F11B	Disconnecting	Re-examine parameter and switch settings. (Confirm if there is no parameter errors and if the corresponding station is properly set at the control station.) Check for cable damage, hardware error, noise, miswiring, station number overlap and control station overlap.
F11F	Initial status (no host-addressed baton)	Re-examine parameter and switch settings. (Confirm if there is no parameter errors and if the corresponding station is properly set at the control station.)
F112	Send error (during bus)	Check if coaxial cable is connected, the connection is loose, terminal resistor is not connected or cable is damaged.
F222	No receiving buffer space (buffer full error)	Retry after waiting for a while. If the error repeats, re-examine the number of transient communication in the entire system and communication intervals, and check if the send destination CPU is in an error (such as no receiving process (END process)).
F701	Specified station number error 1) At data sending: Tried to send to station 0. At data receiving: Received data that is not addressed to the host. 2) Tried to send to a specified control station but it was down.	Correct send destination station number.

Table 9.1 Error code list (continued)

Error No.	Error description	Corrective action
F702	Send destination station number error (Send destination station number is out of range (greater than 65 stations).)	Correct send destination station number.
F703	Send destination group number error (Send destination station number is out of range (greater than 10 (8AH).)	Correct send destination group number.
F705	Send destination CPU error (Send destination hardware error)	Check send destination CPU.
F707	Relay station number error (Send destination is specified out of range (8 stations) that can relay.)	Set transmission possible station. Check the entire system.
F709	Network number error at the time of receiving (Received network number is erroneous.)	Check the network number.
F70B	Response waiting time-out	Retry after waiting for a while.
F7C1	Used a channel that is in use (host).	The same channel cannot be used at the same time. Change channel number or avoid using the same channel at the same time.
F7C2	Target station's channel is in use.	<ul style="list-style-type: none"> • Execute the SEND instruction again after a while. • Confirm there is no multiple requests to the same channel of target station from the host or other stations.
F7C3	Delivery watchdog time expired. (When number of resend is 0)	<ul style="list-style-type: none"> • In the case of error occurrence with the RECV instruction and if other station is executing SEND, set a larger value for delivery watchdog time. • If the host is the instruction execution station, set a larger value for delivery watchdog time. If it still becomes an error, check the network and target stations. • RECV instruction is executed even though RECV instruction execution request flag is not on.

Table 9.1 Error code list (continued)

Error No.	Error description	Corrective action
F7C4	It performed resending for specified times with the number of resend, but could not communicate.	Set a larger value for delivery watchdog time. If it still becomes an error, check the network and target stations.
F7C5	Executed SEND instruction to remote I/O station.	Avoid executing SEND instruction to the remote I/O station.
F7C6	Channel number is out of setting range.	Specify channel number of host and target stations within the range of 1 to 8.
F7C7	Host is specified as target station number.	Specify target station numbers other than the host.
F7C8	Execution type of all-station or group specification is set to "perform delivery checking".	For all-station or group specification, make the execution type to be "no delivery confirmation."
F7C9	Number of resend is out of setting range.	Set within the range of 0 to 15 (times).
F7CA	Delivery watchdog time is out of setting range.	Set within the range of 0 to 32767 (seconds).
F7CB	SEND instruction's transmission data length is out of setting range.	Set within the range of 1 to 480 (words).
F800	Mode switch error	Correct the H/W switch setting.
F801	Network number error	
F803	Station number error	
F804	DIP switch error	
F820	Link parameter error (Parameter content is damaged)	Correct common parameter or station-specific parameter.
F823	Parameter conformity error (Each station's sending range is not "common parameter station-specific parameter.")	
F826	Time comparison error (Host parameter is older than received parameter from subcontrol station.)	Check the control station parameter and reset the host.

Table 9.1 Error code list (continued)

Error No.	Error description	Corrective action
F827	No automatic reconnections	Perform the process according to the setting of no automatic reconnection transfer.
F828	No control station transfer settings	Perform the process according to no control station transfer.
F832	Startup rejected (Started in a condition which disables startup.)	Startup all stations during the data-link stop with the all-station specification. Do not startup the host during the data-link stop with the other station specification.
F833	Key word error (Started from the station different from the station requested the stop.)	Startup from the station that stopped the station. Perform forceful startup.
F837	Retry count over	Check control station's status (whether it is reset or an error had occurred).
F838	Corresponding timer time-out	Check control station's status (whether it is reset or an error had occurred).
F839	Communication disabled (SW0056 is 0)	Repair the cause of disconnection.
F83A	SW0000's request is outside the range	Correct SW0000 contents.
F906	Relay destination CPU error	Check the relay destination CPU.
FA20	Master station routing parameter error	Correct master station's routing parameter.
FA21	Network number, station number, module number, setting error	Correct network number, station number, module number.
FA22	Master station error	Set the routing parameter.
FA23	The header section of request error (SW0SX/NX-GPPQ peripheral device was connected to AnU supported remote I/O module (AJ72LP25, AJ72BR15).)	Connect the SW2SRXV/NX-GPPA peripheral device.
FA24	The data section of request error (SW0SX/NX-GPPQ peripheral device was connected to AnU supported remote I/O module (AJ72LP25, AJ72BR15).)	
FA25	ZNFR/ZNTO execution error (buffer memory address specification error, number of points specification error)	Correct the ZNFR/ZNTO instruction.

Table 9.1 Error code list (continued)

Error No.	Error description	Corrective action
FA26	Special function module handshake error	Execute ZNFR/ZNTO toward special function module.
FA30	I/O allocation error	Correct I/O allocation
FA31	LB/LW allocation error	Correct common parameter (LB/LW).
FA32	Incorrect allocation error	Check the installed modules.
FA33	Number of installed intelligent special function modules error	Install two units or less.
FA34	Special function module sum check error	Check the special function module. → Replacement
FA35	I/O module verification error	Check if any module is disconnected or not.
FA36	Fuse blown error	Check the output module.
FD01	CRC error (off line test)	Retry. (If the error occurs repeatedly, check cable damage, hardware error, noise, missing terminal resistor connection (during bus), miswiring.)
FD02	Overrun error (off line test)	
FD03	AB.IF error (off line test)	
FD04	TIME error (off line test)	
FD05	DATA error (off line test)	
FD06	UNDER error (off line test)	
FD07	Send error	Retry. (If the error occurs repeatedly, check cable damage, hardware error, noise, missing terminal resistor connection (during bus), miswiring.)
FD08	Send error (during bus)	Check if the coaxial cable is not connected or loose, terminal resistor is not connected or cable is damaged.
FD09	Loop status change occurred during the test (off line loop test)	Retry (do not switch the loop during the retry). If the error occurs repeatedly, check the line and connection conditions.
FD0A	Communication unstable (off line loop test)	Retry. If the error occurs repeatedly, check cable damage, hardware error, noise, missing terminal resistor connection (during bus) or loose wiring.
FD0B	Wiring error (off line loop test)	Check the wiring.
FD11	Test in-progress error	Perform after completing a test from the other station.
FD12	Disconnection error	Repair the cause of disconnection.

Table 9.1 Error code list (continued)

Error No.	Error description	Corrective action
FD13	Station number error 1) On line diagnosis specified by the parameter was performed when the parameter was not received. 2) On line diagnosis was performed with smaller number of stations specified than the host station number.	1) Set total link station number with common parameter. 2) Set the same station number as the host or greater.
FD1A	There is overlapped station numbers (during station sequence confirmation test).	Check station overlap and correct it.
FD1B	Test interruption error	Test performing station is interrupted with reset, etc. during the test. There is a faulty station on the line.
FD1C	Interruption error caused by the loop switch during the test	Retry (do not switch loop during the test). If the error occurs repeatedly, check line and connection conditions.
FD1E	Test disable error for the bus type	Perform the test that can be executed on the bus type.
FD31	On-line diagnosis double-request error (On-line diagnosis requests were issued at the same time.)	Perform again after the first on-line diagnosis is completed.
FD35	Response waiting time-out occurred	Retry after a while. Check corresponding station and line conditions. Change test request destination.
FD36	Corresponding waiting time-out occurred	
FD38	Message overlap error	
FD39	Test requested to the host (communication test)	Change the test request destination.
FD3A	Test request destination is request reject station (communication test)	A station that cannot accept test request is requested. Communication-request reject station  <p>..... Communication-request reject station</p>

Table 9.1 Error code list (continued)

Error No.	Error description	Corrective action
FE20	Data error (Not able to process the received data, other than AnUCPU is specified as a relay station.)	Correct routing parameter, or change the relay station to AnUCPU.
FE21	LWDP/LWTP device range error	Check the counter-side CPU device range.
FE22	QnACPU request contents error	Data length error of general data, etc.

10. External Dimensions

10.1 A1SJ71QLP21

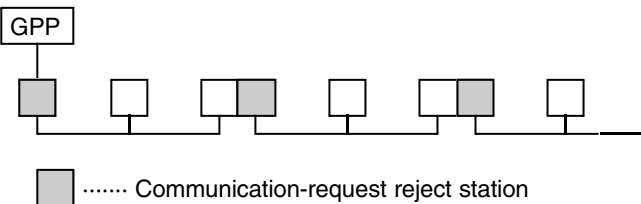
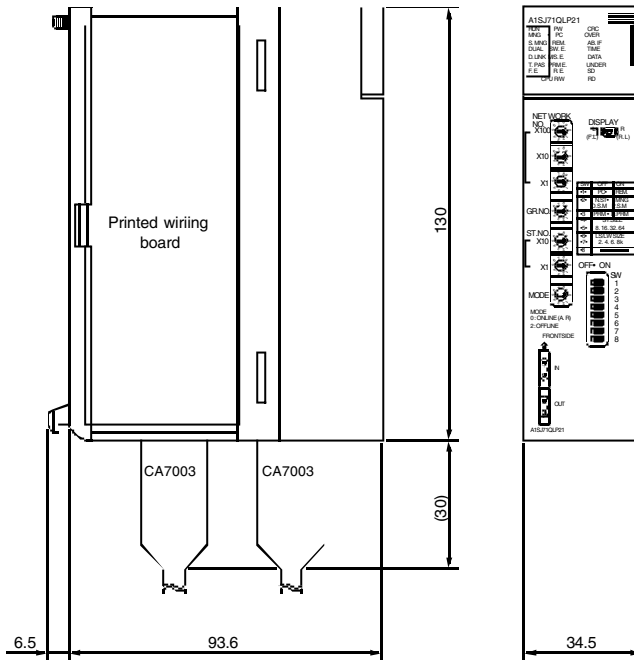

* Consider the radius of the bend in the cable. (Refer to reference manual)

10.2 A1SJ71QLP21 (S)

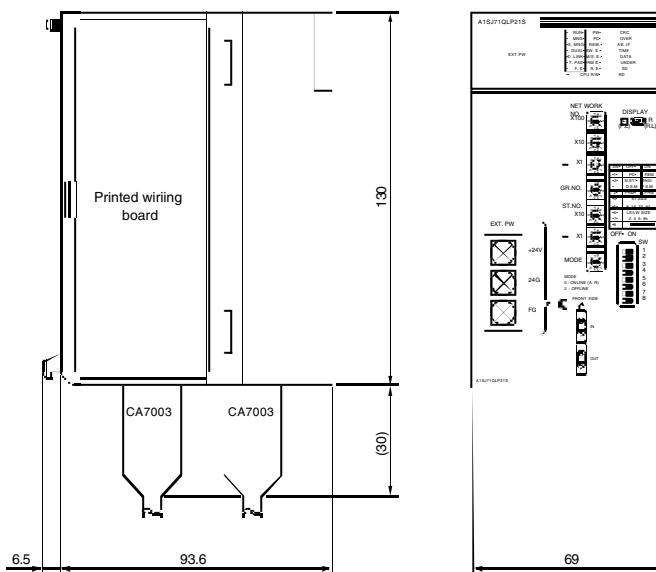

* Consider the radius of the bend in the cable. (Refer to reference manual)

10.3 A1SJ71QBR11

